



U6 Week6 MCQ

All working must be shown in full on the M.A.T

Name: _____

Class: _____

Date: _____

Time: **30 minutes**

Marks: **30 marks**

Comments: **1 mark correct for workings, 1 mark correct answer. Do not write on and submit this paper. USE THE MCQ Answer Template on GoL**

1

Which row shows the correct interactions experienced by a hadron or a lepton?

	Particle	Strong interaction	Weak interaction	
A	Hadron	Yes	Yes	<input type="checkbox"/>
B	Lepton	Yes	Yes	<input type="checkbox"/>
C	Hadron	Yes	No	<input type="checkbox"/>
D	Lepton	Yes	No	<input type="checkbox"/>

(Total 1 mark)

2

Which statement is correct about the properties of an unpolarised electromagnetic wave as it passes through a polariser?

A The wave remains unchanged.

B The wave does not pass through the polariser.

C The wave's electric field oscillates along the direction of travel.

D The intensity of the wave is reduced.

(Total 1 mark)

3

In the circuit below, the potential difference across the light emitting diode (LED) is 1.8 V when it is emitting light.

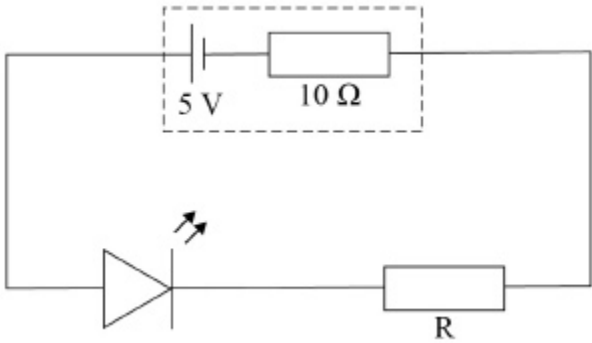

The current in the circuit is 20 mA.

What is the value of the resistor R?

- A 80 Ω
- B 90 Ω
- C 150 Ω
- D 160 Ω

(Total 1 mark)

4

Which graph shows the variation of the resistance with temperature for an ntc thermistor?

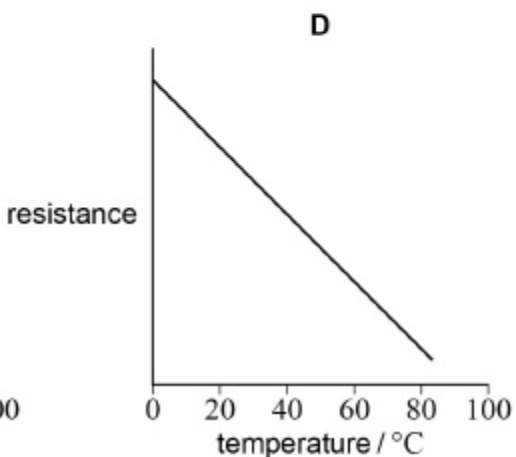
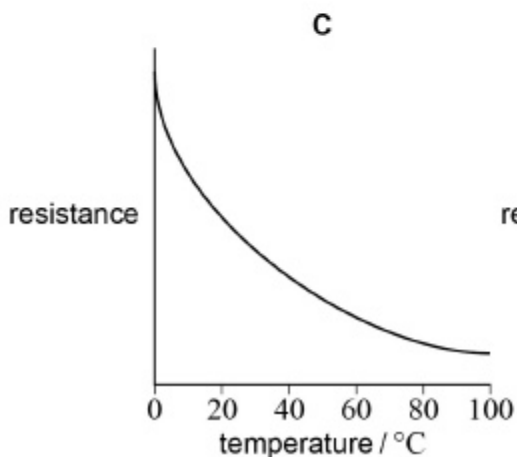
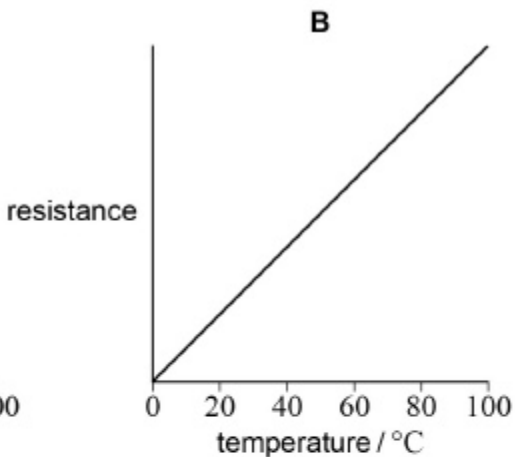
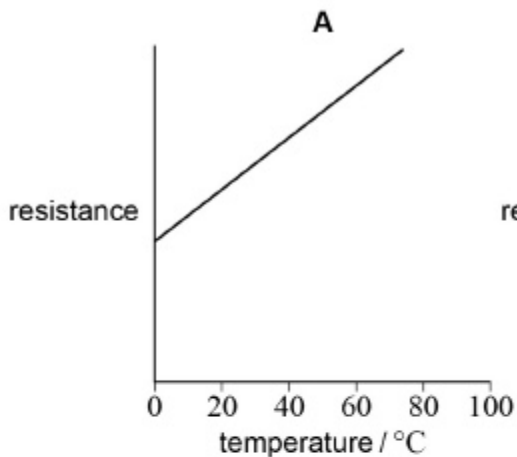

- A
- B
- C
- D

(Total 1 mark)

5 What interactions are involved in the production of a strange particle and its decay into non-strange particles?

	Production	Decay	
A	strong	weak	<input type="checkbox"/>
B	strong	strong	<input type="checkbox"/>
C	weak	strong	<input type="checkbox"/>
D	weak	weak	<input type="checkbox"/>

(Total 1 mark)

6 Two separate wires **X** and **Y** have the same original length and cross-sectional area.

The graph shows the extension ΔL produced in **X** and **Y** when the tensile force F applied to the wires is increased up to the point where they break.

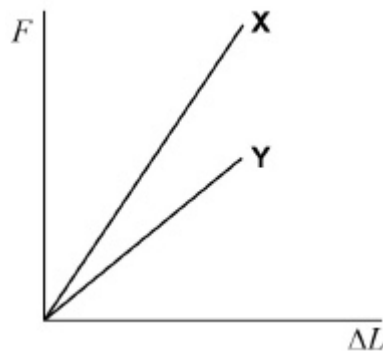

Which statement is **incorrect**?

- A** For a given extension more energy is stored in **X** than in **Y**.
- B** The Young modulus of the material of wire **Y** is greater than that of wire **X**.
- C** Both wire **X** and wire **Y** obey Hooke's law.
- D** Wire **X** has a greater breaking stress than wire **Y**.

(Total 1 mark)

7 An atom of ${}^{16}_7\text{N}$ gains 3 electrons.

What is the specific charge of the ion?

- A $1.80 \times 10^7 \text{ C kg}^{-1}$
- B $-1.80 \times 10^7 \text{ C kg}^{-1}$
- C $4.19 \times 10^7 \text{ C kg}^{-1}$
- D $-4.19 \times 10^7 \text{ C kg}^{-1}$

(Total 1 mark)

8 Electrons moving in a beam have the same de Broglie wavelength as protons in a separate beam moving at a speed of $2.8 \times 10^4 \text{ m s}^{-1}$.

What is the speed of the electrons?

- A $1.5 \times 10^1 \text{ m s}^{-1}$
- B $2.8 \times 10^4 \text{ m s}^{-1}$
- C $1.2 \times 10^6 \text{ m s}^{-1}$
- D $5.1 \times 10^7 \text{ m s}^{-1}$

(Total 1 mark)

9

Intensity maxima are produced on a screen when a parallel beam of monochromatic light is incident on a diffraction grating. Light of a longer wavelength can be used or the distance from the diffraction grating to the screen can be increased.

Which row gives the change in appearance of the maxima when these changes are made independently?

	Longer wavelength	Distance from grating to screen increased	
A	closer together	more widely spaced	<input type="checkbox"/>
B	more widely spaced	more widely spaced	<input type="checkbox"/>
C	more widely spaced	closer together	<input type="checkbox"/>
D	closer together	closer together	<input type="checkbox"/>

(Total 1 mark)

10

The diagram shows the path of a projectile launched from ground level with a speed of 25 m s^{-1} at an angle of 42° to the horizontal.

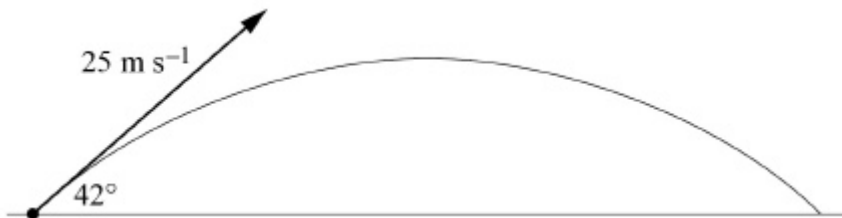

What is the horizontal distance from the starting point of the projectile when it hits the ground?

- A** 23 m
- B** 32 m
- C** 47 m
- D** 63 m

(Total 1 mark)

11 When a monochromatic light source is incident on two slits of the same width an interference pattern is produced.

One slit is then covered with opaque black paper.

What is the effect of covering one slit on the resulting interference pattern?

- A The intensity of the central maximum will increase
- B The width of the central maximum decreases
- C Fewer maxima are observed
- D The outer maxima become wider

(Total 1 mark)

12 The diagram shows a uniform metre ruler of weight 1.5 N pivoted 15 cm from one end for use as a simple balance.

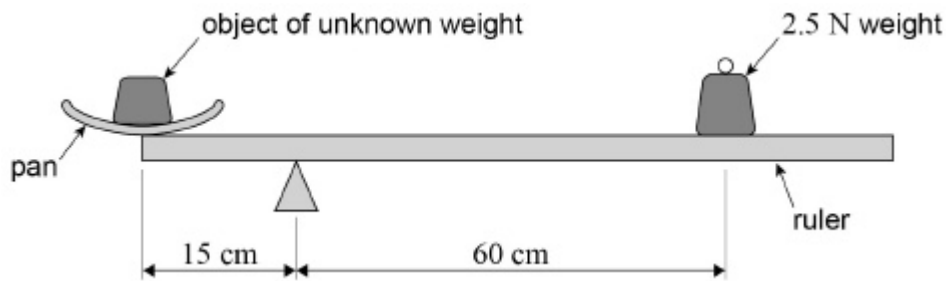

A scale pan of weight 0.5 N is placed at the end of the ruler and an object of unknown weight is placed in the pan. The ruler moves to a steady horizontal position when a weight of 2.5 N is added at a distance of 60 cm from the pivot as shown.

What is the weight of the object?

- A 9.5 N
- B 10.0 N
- C 13.0 N
- D 13.5 N

(Total 1 mark)

13

Two identical balls, **X** and **Y**, are at the same height and a horizontal distance of 25 cm apart.

X is projected horizontally with a velocity of 0.10 m s^{-1} towards **Y** at the same time that **Y** is released from rest. Both **X** and **Y** move freely in the absence of air resistance.

What is the distance between the balls 1.0 s later?

A 0.15 m

B 0.25 m

C 2.4 m

D 4.9 m

(Total 1 mark)

14

Which row shows the change in velocity, frequency and wavelength of an electromagnetic wave as it travels from an optically less dense to an optically more dense medium?

	Velocity	Frequency	Wavelength	
A	decreases	decreases	unchanged	<input type="checkbox"/>
B	increases	unchanged	increases	<input type="checkbox"/>
C	decreases	unchanged	decreases	<input type="checkbox"/>
D	increases	increases	unchanged	<input type="checkbox"/>

(Total 1 mark)

15

A battery of negligible internal resistance and an emf of 12 V is connected in series with a heating element. The heating element has a resistance of 6.5Ω when in operation.

What is the energy transferred by the heating element when operating for 5 minutes?

A 111 J

B 390 J

C 6650 J

D 23 400 J

(Total 1 mark)