

Write your name here

Surname

Other names

Pearson Edexcel
Level 1 / Level 2
GCSE (9-1)

Centre Number

--	--	--	--	--

Candidate Number

--	--	--	--

Mathematics

Paper 1 (Non-Calculator)

Foundation Tier

Thursday 25 May 2017 – Morning

Time: 1 hour 30 minutes

Paper Reference

1MA1/1F

You must have: Ruler graduated in centimetres and millimetres,
 protractor, pair of compasses, pen, HB pencil, eraser.
 Tracing paper may be used.

Total Marks



Instructions

- Use **black** ink or ball-point pen.
- **Fill in the boxes** at the top of this page with your name, centre number and candidate number.
- Answer **all** questions.
- Answer the questions in the spaces provided
 – *there may be more space than you need.*
- You must **show all your working**.
- Diagrams are **NOT** accurately drawn, unless otherwise indicated.
- **Calculators may not be used.**

Information

- The total mark for this paper is 80
- The marks for **each** question are shown in brackets
 – *use this as a guide as to how much time to spend on each question.*

Advice

- Read each question carefully before you start to answer it.
- Keep an eye on the time.
- Try to answer every question.
- Check your answers if you have time at the end.

Turn over ▾

P48134A

©2017 Pearson Education Ltd.
 6/6/6/6/6/7/7/14/



P 4 8 1 3 4 A 0 1 2 0



Pearson

Answer ALL questions.

Write your answers in the spaces provided.

You must write down all the stages in your working.

- 1 Work out the value of 2^4

$$2 \times 2 \times 2 \times 2$$

16

(Total for Question 1 is 1 mark)

- 2 Write 7.264¹51 correct to 3 decimal places.

7.265

(Total for Question 2 is 1 mark)

- 3 (a) Simplify $7 \times e \times f \times 8$

56ef

(1)

(b) Solve $\frac{x}{5} = 2\frac{1}{2} = \frac{5}{2}$

$$x = \frac{5}{2} \times 5$$

$$x = \frac{25}{2} = 12\frac{1}{2}$$

(1)

(Total for Question 3 is 2 marks)

- 4 Write $\frac{4}{5}$ as a percentage.

$$\frac{4}{5} = \frac{8}{10}$$

80

%

(Total for Question 4 is 1 mark)

DO NOT WRITE IN THIS AREA



5 Work out 60% of 70

$$\begin{array}{r} \times 60 \\ 70 \\ \hline 420 \end{array} \quad \begin{array}{r} 7 \\ \times 6 \\ \hline 42 \end{array}$$

42

(Total for Question 5 is 2 marks)

6 Sammy spins a fair 4-sided spinner.

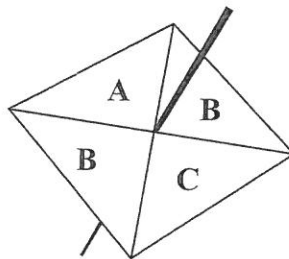

(i) On the probability scale, mark with a cross (×) the probability that the spinner will land on B.

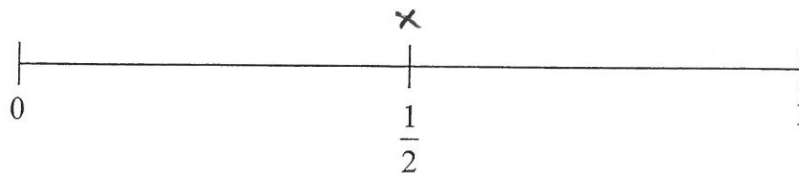

(1)

(ii) On the probability scale, mark with a cross (×) the probability that the spinner will land on F.

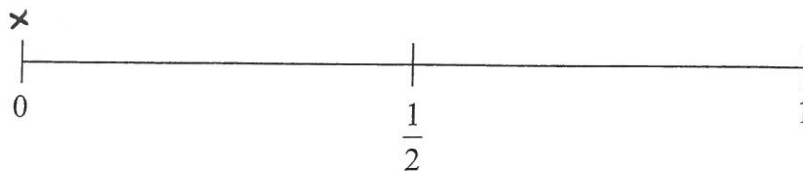

(1)

(Total for Question 6 is 2 marks)

7 Fahima buys

- 2 packets of bread rolls costing £1.50 for each packet $2 \times \pounds 1.50 = \pounds 3$
- 1 bottle of ketchup costing £1.60
- 3 packets of sausages

Fahima pays with a £10 note.
She gets 30p change.

Fahima works out that one packet of sausages costs £2.30

Is Fahima right?
You must show how you get your answer.

$$\text{BREAD} + \text{KETCHUP IS } \pounds 3 + \pounds 1.60 = \pounds 4.60$$

$$\text{TOTAL SPEND} = \pounds 10 - \pounds 0.30 = \pounds 9.70$$

$$\therefore \text{SAUSAGES ARE } \pounds 9.70 - \pounds 4.60 = \pounds 5.10$$

$$\therefore \text{1 PACKET IS } \frac{5.10}{3} = \pounds 1.70$$

FAHIMA IS WRONG.

(Total for Question 7 is 3 marks)

8 (a) Work out $\frac{5}{8} \times \frac{3}{4}$

$$\frac{15}{32}$$

(1)

(b) Work out $\frac{2}{3} - \frac{1}{4}$

$$\frac{8-3}{12}$$

$$\frac{5}{12}$$

(2)

(Total for Question 8 is 3 marks)



DO NOT WRITE IN THIS AREA

DO NOT WRITE IN THIS AREA

DO NOT WRITE IN THIS AREA

- 9 Sean works for a company.
His normal rate of pay is £12 per hour.

When Sean works more than 8 hours a day, he is paid overtime for each hour he works more than 8 hours.

Sean's rate of overtime pay per hour is $1\frac{1}{4}$ times his normal rate of pay per hour.

On Monday Sean worked for 10 hours.

Work out the total amount of money Sean earned on Monday.

$$8 \times 12 = \text{£}96$$

$$2 \times 12 \times 1\frac{1}{4} = 24 \times \frac{5}{4} = \text{£}30$$

$$96 + 30 = \text{£}126$$

£ 126.

(Total for Question 9 is 4 marks)

- 10 A farmer has 20 boxes of eggs.
There are 6 eggs in each box.

Write, as a ratio, the number of eggs in two boxes to the total number of eggs.
Give your answer in its simplest form.

$$\text{TOTAL EGGS} = 6 \times 20 = 120$$

$$\text{EGGS IN 2 BOXES} = 6 \times 2 = 12$$



$$12 : 120$$

$$= 1 : 10$$

1 : 10

(Total for Question 10 is 2 marks)



11 A sequence of patterns is made from circular tiles  and square tiles 

Here are the first three patterns in the sequence.

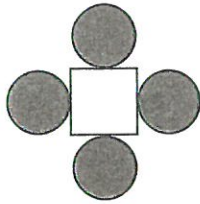

pattern number 1

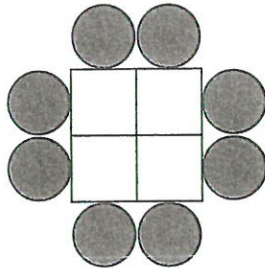

pattern number 2

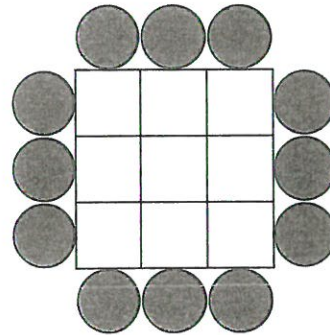

pattern number 3

(a) How many square tiles are needed to make pattern number 6?

$$6^2 = 36,$$

36

(2)

(b) How many circular tiles are needed to make pattern number 20?

$$4 \times 20$$

80

(2)

Derek says,

“When the pattern number is odd, an odd number of square tiles is needed to make the pattern.”

(c) Is Derek right?

You must give reasons for your answer.

NUMBER OF SQUARE TILES = PATTERN NUMBER SQUARED
 SO IF PATTERN NO. IS ODD WE HAVE ODD x ODD
 WHICH IS ODD SO DEREK IS RIGHT.

(2)

(Total for Question 11 is 6 marks)



DO NOT WRITE IN THIS AREA

12 There are only 7 blue pens, 4 green pens and 6 red pens in a box.

One pen is taken at random from the box.

Write down the probability that this pen is blue.

$$\text{TOTAL} = 17$$

$$\frac{7}{17}$$

(Total for Question 12 is 2 marks)

13 The diagram shows a tree and a man.



The man is of average height.

The tree and the man are drawn to the same scale.

(a) Write down an estimate for the real height, in metres, of the man.

$$\frac{2}{(1.5 - 2.0)} \quad (1) \quad \text{metres}$$

(b) Find an estimate for the real height, in metres, of the tree.

TREE 5cm

MAN 1cm

\therefore TREE IS 5 TIMES HIGHER

$$\frac{10}{(7.5 - 12)} \quad (2) \quad \text{metres}$$

(Total for Question 13 is 3 marks)

14 Year 9 students from Halle School were asked to choose one language to study.

The table shows information about their choices.

Language	Number of students	NUMBER OF DEGREES	
French	56	168	56×3
Spanish	40	120	3×40
German	24	72	3×24
	120	360	

(a) Draw an accurate pie chart to show this information.

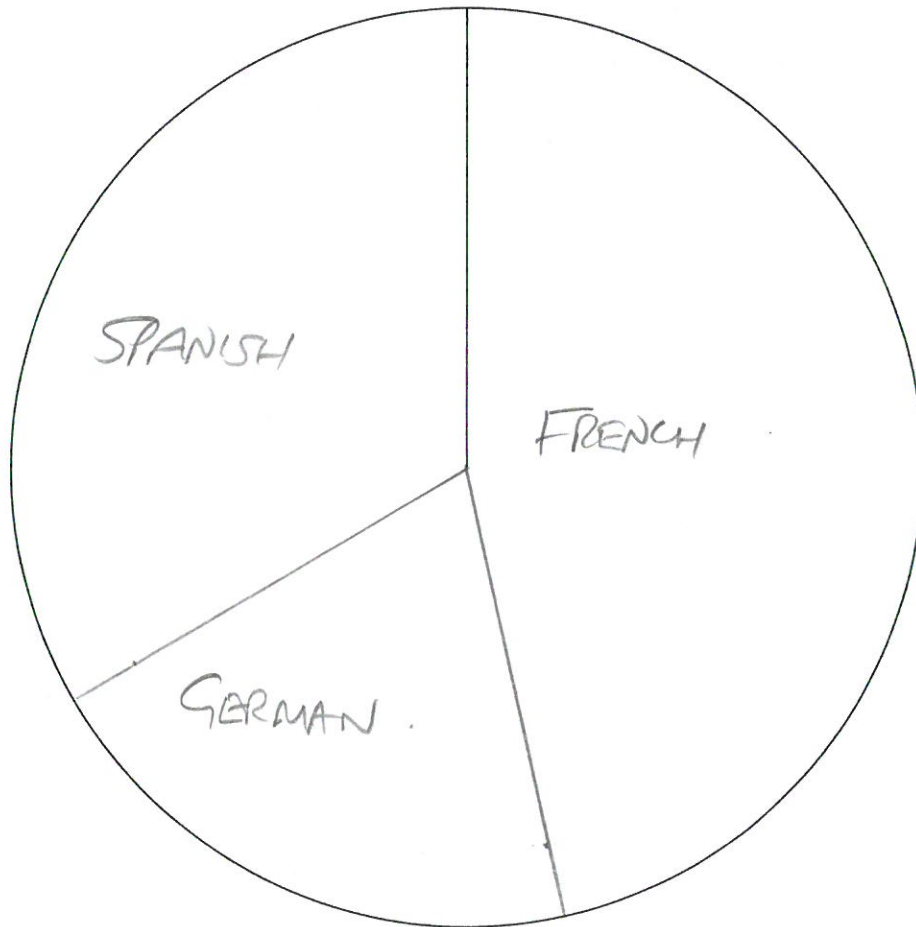

(3)



DO NOT WRITE IN THIS AREA

Year 9 students from Lowry School were also asked to choose one language to study.

This accurate pie chart shows information about their choices.

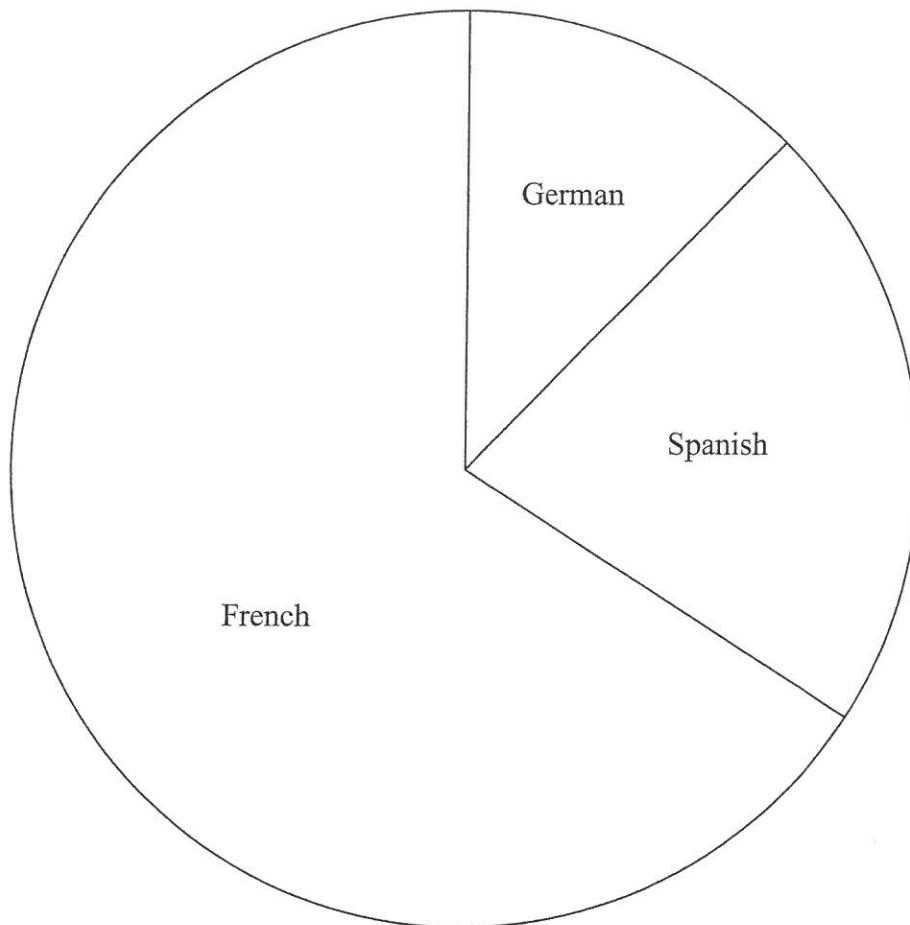

Shameena says,

“The pie chart shows that French was chosen by more Year 9 students at Lowry School than at Halle School.”

(b) Is Shameena right?

You must explain your answer.

CANNOT TELL BECAUSE DON'T KNOW HOW MANY STUDENTS
IN Y9 AT LOWRY SCHOOL. WE ONLY KNOW THAT A
GREATER PROPORTION CHOSE FRENCH AT LOWRY.

(1)

(Total for Question 14 is 4 marks)

15 Here are a triangle and a rectangle.

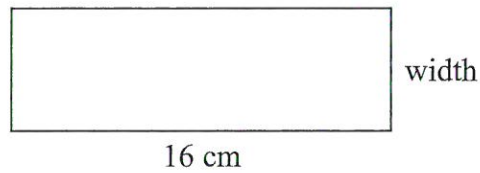
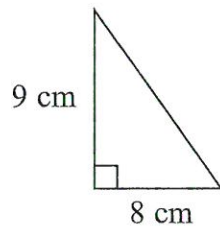

The area of the rectangle is 6 times the area of the triangle.

Work out the width of the rectangle.

$$\text{AREA OF TRIANGLE} = \frac{1}{2} \times 8 \times 9 = 36 \text{ cm}^2$$

$$\text{AREA OF RECTANGLE} = 6 \times 36 = 216 \text{ cm}^2$$

$$\therefore 16 \times \text{WIDTH} = 216$$

$$\therefore \text{WIDTH} = \frac{216}{16} = \frac{108}{8} = \frac{54}{4} = 13.5$$

..... 13.5 cm

(Total for Question 15 is 4 marks)

16 $v = u + at$

$$u = 1 \quad a = -3 \quad t = \frac{1}{2}$$

Work out the value of v .

$$\begin{aligned} & 1 + -3 \times \frac{1}{2} \\ &= 1 - 1.5 \\ &= -0.5 \end{aligned}$$

$v =$ -0.5

(Total for Question 16 is 2 marks)



17 5 tins of soup have a total weight of 1750 grams.

4 tins of soup and 3 packets of soup have a total weight of 1490 grams.

Work out the total weight of 3 tins of soup and 2 packets of soup.

$$\begin{array}{l} \text{Tin of} \\ 1 \text{ tin of SOUP is } \frac{1750}{5} = 350\text{g.} \end{array}$$

$$\therefore 4 \text{ tins of SOUP is } 4 \times 350 = 1400\text{g}$$

$$\therefore 3 \text{ packets of SOUP is } 1490 - 1400 = 90\text{g}$$

$$\therefore 1 \text{ packet is } \frac{90}{3} = 30\text{g.}$$

$$\begin{aligned} \therefore 3 \text{ tins} + 2 \text{ packets} &= 3 \times 350 + 2 \times 30 \\ &= 1050 + 60 \\ &= 1110 \end{aligned}$$

1110

grams

(Total for Question 17 is 4 marks)

- 18 Balena has a garden in the shape of a circle of radius 10 m.
He is going to cover the garden with grass seed to make a lawn.

Grass seed is sold in boxes.

Each box of grass seed will cover 46 m^2 of garden.

Balena wants to cover all the garden with grass seed.

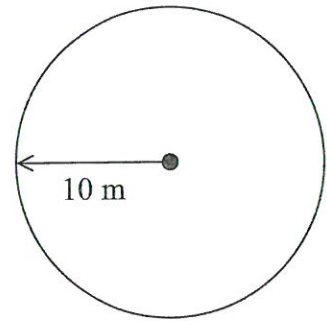

- (a) Work out an estimate for the number of boxes of grass seed Balena needs.
You must show your working.

$$\text{AREA} = \pi \times 10^2 = 100\pi \approx 300 \text{ m}^2$$

$$\text{EACH BOX COVER } 46 \text{ m}^2 \approx 50 \text{ m}^2$$

$$\therefore \text{REQUIRE } \frac{300}{50} = 6 \text{ BOXES}$$

$$\begin{array}{r} 6 \\ \hline (6-8) \quad (4) \end{array}$$

- (b) Is your estimate for part (a) an underestimate or an overestimate?
Give a reason for your answer.

UNDERESTIMATE BECAUSE AREA IS ACTUALLY GREATER
THAN 300 m^2 AND THIS BIGGER AREA SHOULD BE
DIVIDED BY 46 RATHER THAN 50, SO ANSWER WILL BE
MORE THAN 6.

(1)

(Total for Question 18 is 5 marks)



19 (a) Solve $4(x-5) = 18$

$$4x - 20 = 18$$

$$4x = 18 + 20 = 38$$

$$x = \frac{38}{4} = \frac{19}{2}$$

$$x = \frac{19}{2} \quad (2)$$

$$-3 < t \leq 2$$

t is an integer.

(b) Write down all the possible values of t .

$$-2, -1, 0, 1, 2 \quad (2)$$

(Total for Question 19 is 4 marks)

20 Azmol is paid £1500 per month.

He is going to get a 3% increase in the amount of money he is paid.

Work out how much money Azmol will be paid per month after the increase.

$$10\% \quad 150$$

$$1\% \quad 15$$

$$3\% \quad 45$$

$$1500 + 45 = 1545$$

$$£ 1545$$

(Total for Question 20 is 2 marks)

23 Work out 54.6×4.3

$$\begin{array}{r} 54.6 \\ \times 4.3 \\ \hline 1638 \\ 21840 \\ \hline 23478 \end{array}$$

234.78

(Total for Question 23 is 3 marks)



21 The scatter graph shows the maximum temperature and the number of hours of sunshine in fourteen British towns on one day.

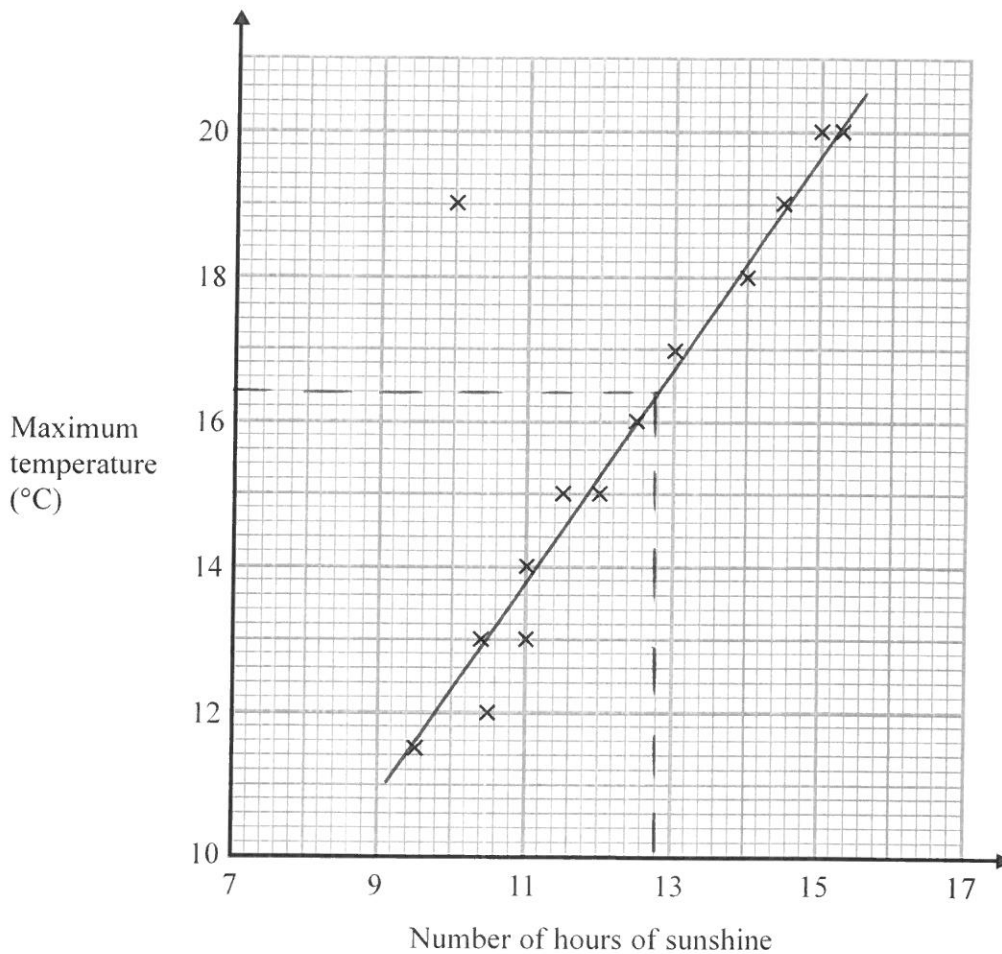

One of the points is an outlier.

(a) Write down the coordinates of this point.

(10 , 19)
(1)

(b) For all the other points write down the type of correlation.

POSITIVE
(1)



DO NOT WRITE IN THIS AREA

DO NOT WRITE IN THIS AREA

DO NOT WRITE IN THIS AREA

On the same day, in another British town, the maximum temperature was 16.4°C .

(c) Estimate the number of hours of sunshine in this town on this day.

12.8 hours
 $(12-13)$ (2)

A weatherman says,

“Temperatures are higher on days when there is more sunshine.”

(d) Does the scatter graph support what the weatherman says?
Give a reason for your answer.

THE MAXIMUM TEMPERATURE IS HIGHER WHEN THERE IS MORE
SUNSHINE (ie POSITIVE CORRELATION) SO SCATTER GRAPH SUPPORTS
THE STATEMENT (1)

(Total for Question 21 is 5 marks)

22 Express 56 as the product of its prime factors.

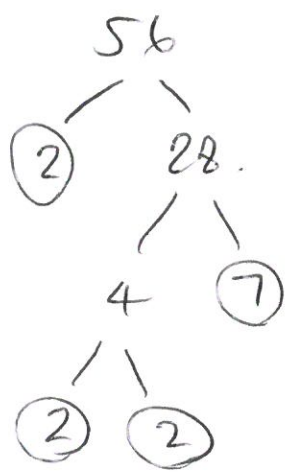

$$56 = 2 \times 2 \times 2 \times 7$$

$$2^3 \times 7$$

(Total for Question 22 is 2 marks)



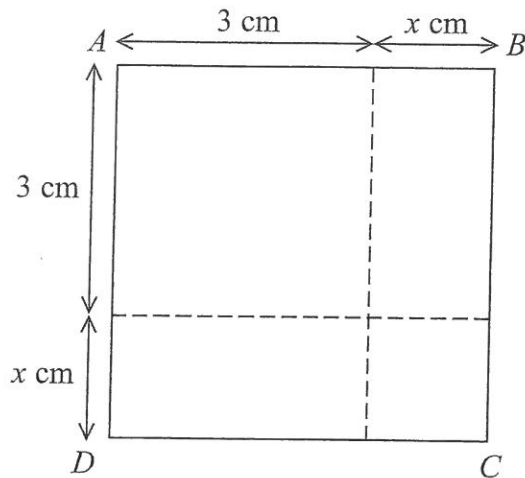

The area of square $ABCD$ is 10 cm^2 .

Show that $x^2 + 6x = 1$

$$(x+3)^2 = 10$$

$$\therefore (x+3)(x+3) = 10$$

$$\therefore x^2 + 6x + 9 = 10$$

$$\therefore x^2 + 6x = 10 - 9$$

$$\therefore x^2 + 6x = 1$$

(Total for Question 24 is 3 marks)



25 This rectangular frame is made from 5 straight pieces of metal.

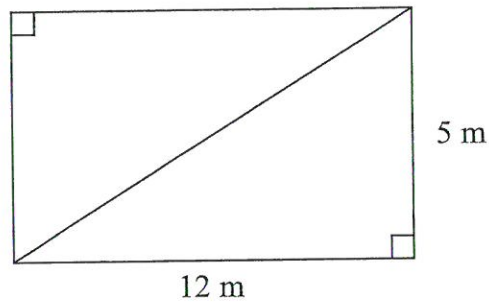

The weight of the metal is 1.5 kg per metre.

Work out the total weight of the metal in the frame.

$$\text{DIAGONAL} = \sqrt{5^2 + 12^2} = 13 \text{ m}$$

$$\begin{aligned} \therefore \text{TOTAL LENGTH} &= 5 + 12 + 5 + 12 + 13 \\ &= 47 \text{ m} \end{aligned}$$

$$\begin{aligned} \therefore \text{TOTAL WEIGHT} &= 47 \times 1.5 \\ &= 47 + 23.5 \\ &= 70.5 \end{aligned}$$

70.5 kg

(Total for Question 25 is 5 marks)



- 26 The equation of the line L_1 is $y = 3x - 2$
The equation of the line L_2 is $3y - 9x + 5 = 0$

Show that these two lines are parallel.

$$L_2 \quad 3y = 9x - 5$$

$$y = 3x - \frac{5}{3}$$

\therefore GRADIENT = 3 FOR BOTH LINES

\therefore LINES ARE PARALLEL

(Total for Question 26 is 2 marks)



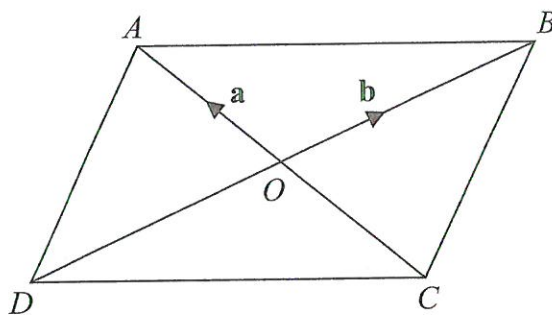

$ABCD$ is a parallelogram.

The diagonals of the parallelogram intersect at O .

$$\vec{OA} = \mathbf{a} \text{ and } \vec{OB} = \mathbf{b}$$

(a) Find, in terms of \mathbf{b} , the vector \vec{DB} .

$$\frac{2\mathbf{b}}{(1)}$$

(b) Find, in terms of \mathbf{a} and \mathbf{b} , the vector \vec{AB} .

$$\frac{-\mathbf{a} + \mathbf{b}}{(1)}$$

(c) Find, in terms of \mathbf{a} and \mathbf{b} , the vector \vec{AD} .

$$\frac{-\mathbf{a} - \mathbf{b}}{(1)}$$

(Total for Question 27 is 3 marks)

TOTAL FOR PAPER IS 80 MARKS

