

ANSWERS.

Write your name here

Surname

Other names

Centre Number

Candidate Number

**Pearson Edexcel**  
**Level 1/Level 2 GCSE (9–1)**

# Mathematics

## Paper 2 (Calculator)

**Foundation Tier**

Monday 6 November 2017 – Morning

**Time: 1 hour 30 minutes**

Paper Reference

**1MA1/2F**

**You must have:** Ruler graduated in centimetres and millimetres, protractor, pair of compasses, pen, HB pencil, eraser, calculator. Tracing paper may be used.

Total Marks

### Instructions

- Use **black** ink or ball-point pen.
- **Fill in the boxes** at the top of this page with your name, centre number and candidate number.
- Answer **all** questions.
- Answer the questions in the spaces provided – *there may be more space than you need.*
- You must **show all your working**.
- Diagrams are **NOT** accurately drawn, unless otherwise indicated.
- **Calculators may be used.**
- If your calculator does not have a  $\pi$  button, take the value of  $\pi$  to be 3.142 unless the question instructs otherwise.



### Information

- The total mark for this paper is 80
- The marks for **each** question are shown in brackets – *use this as a guide as to how much time to spend on each question.*

### Advice

- Read each question carefully before you start to answer it.
- Keep an eye on the time.
- Try to answer every question.
- Check your answers if you have time at the end.

Turn over ►

P49360A

©2017 Pearson Education Ltd.

6/6/17/2/



  
**Pearson**

Answer ALL questions.

Write your answers in the spaces provided.

You must write down all the stages in your working.

- 1 Write  $\frac{7}{100}$  as a decimal.

0.07

(Total for Question 1 is 1 mark)

- 2 Write down a multiple of 6 that is between 40 and 50

42 (or 48)

(Total for Question 2 is 1 mark)

- 3 (a) Simplify  $3f \times 5g$

15fg  
(1)

- (b) Simplify  $t \times t$

t<sup>2</sup>  
(1)

- (c) Simplify  $\frac{2n + 6n}{2} = \frac{8n}{2}$

4n  
(1)

(Total for Question 3 is 3 marks)



4 Ken buys some fruit.

He buys apples, bananas, peaches and oranges.

Ken buys

4 apples	weighing 125 g each	$4 \times 125 =$	500
2 bananas	weighing 170 g each	$2 \times 170 =$	340
3 peaches	weighing 135 g each	$3 \times 135 =$	405

$$\underline{1245} \text{ g}$$

Each orange has a weight of 90 g.

The fruit has a total weight of 1.785 kg. = 1785 g

(a) Work out how many oranges Ken buys.

$$1785 - 1245 = 540 \text{ g}$$

$$\frac{540}{90} = 6$$

6

(3)

Jane wants to buy 15 tomatoes.

She asks for 1 kg of tomatoes at a shop.

Jane assumes that each tomato has a weight of 75 g.

(b) (i) If Jane's assumption is correct, will she get 15 tomatoes?

You must show how you get your answer.

$$15 \times 75 = 1125 \text{ g}$$

$1125 \text{ g} = 1.125 \text{ kg}$   $\therefore$  JANE WILL NOT GET 15 TOMATOES

(2)

(ii) If Jane's assumption is **not** correct, could she get 15 tomatoes?

Justify your answer.

YES, IF EACH TOMATO WEIGHED  $\frac{1000}{15} = 66\frac{2}{3} \text{ g}$  AT MOST.

(1)

(Total for Question 4 is 6 marks)



5 60 students were asked how they get to school.

The table shows the results.

	Bus	Walk	Car	Bicycle
Number of students	15	27	12	6

(a) What fraction of the 60 students did **not** walk to school?

$$1 - \frac{27}{60} = \frac{33}{60} = \frac{11}{20}$$

$$\left(\frac{11}{20}\right) \text{ (or } \frac{33}{60} \text{)} \quad (2)$$

(b) Complete the pie chart for the information in the table.

60 STUDENTS =  $360^\circ$       $\therefore$  BUS  $90^\circ$   
 $\therefore$  1 STUDENT =  $6^\circ$              WALK  $162^\circ$   
    CAR  $72^\circ$   
    BICYCLE  $36^\circ$   
     $\underline{360^\circ}$

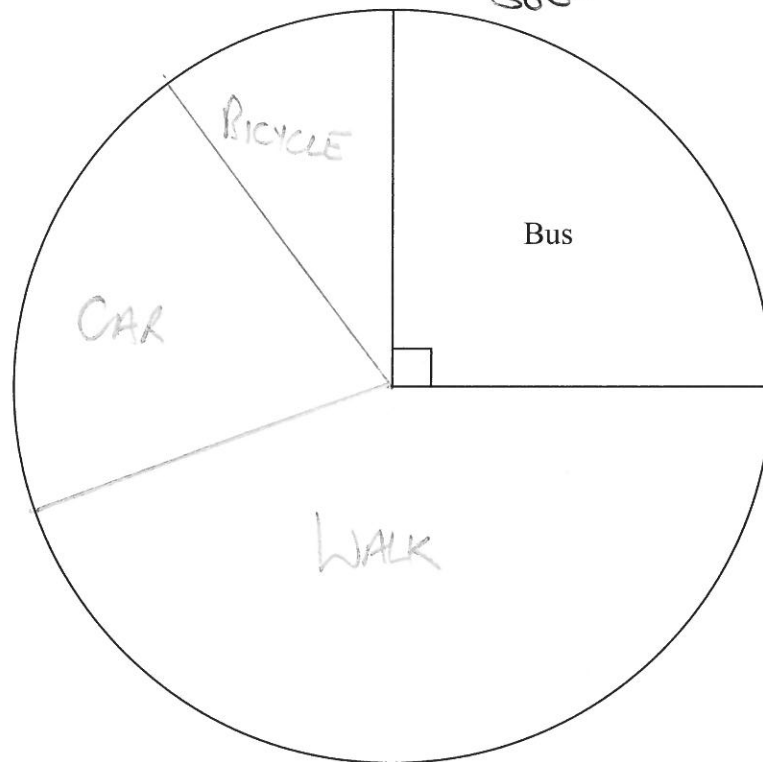

(4)

(Total for Question 5 is 6 marks)



DO NOT WRITE IN THIS AREA

6 Annie and Lily share some money in the ratio 4 : 3

(a) What fraction of the money does Lily get?

$\frac{3}{7}$

(1)

Rosie and Dan share some sweets.

Dan gets  $\frac{1}{4}$  of the sweets.

(b) Write down the ratio of the number of sweets Rosie gets to the number of sweets Dan gets.

3:1

(1)

(Total for Question 6 is 2 marks)

7 Steve says,

“There are more prime numbers between 20 and 30  
than there are between 10 and 20”

Is Steve right?

You must show how you get your answer.

10 - 20 : 11, 13, 17, 19

20 - 30 : 23, 29

∴ STEVE IS WRONG.

(Total for Question 7 is 2 marks)



- 8 Chrissy drew this graph to show the percentage of buses that got to a bus stop on time for six months.

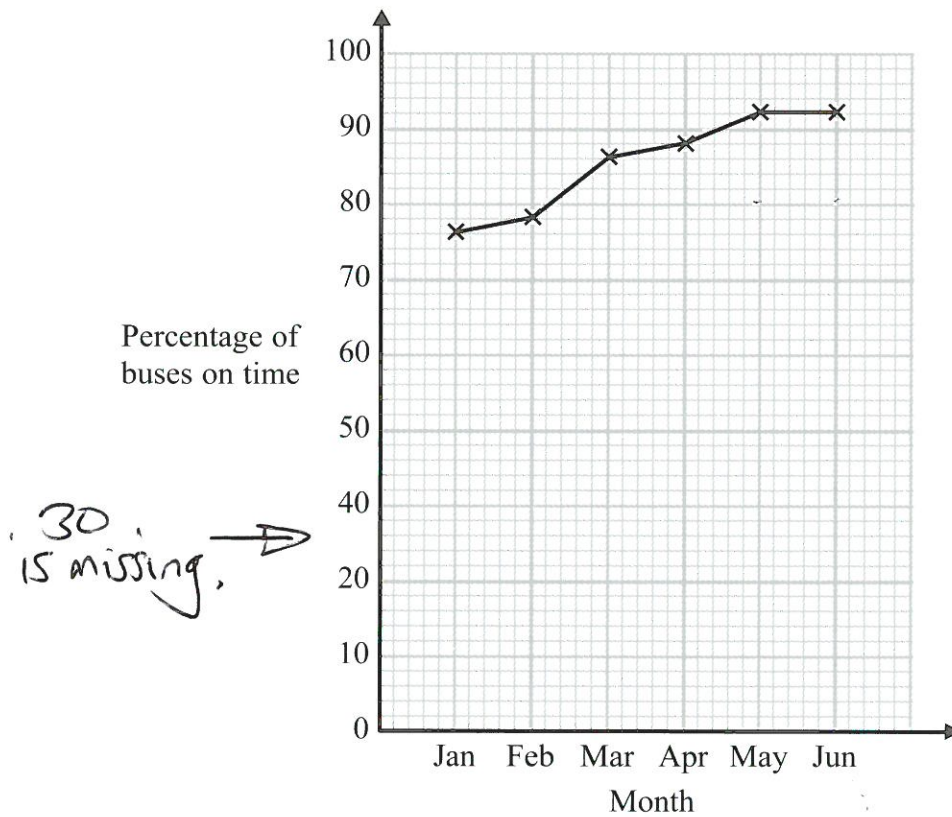

- (a) Write down **one** thing that is wrong with the graph.

*VERTICAL SCALE IS NOT  
POINTS SHOULD BE PLOTTED AT MIDPOINT OF LINEAR  
MONTHS, NOT AT END OF MONTH.*

(1)

- (b) Describe the trend in the percentage of buses that got to the bus stop on time.

*INCREASING*

(1)

(Total for Question 8 is 2 marks)

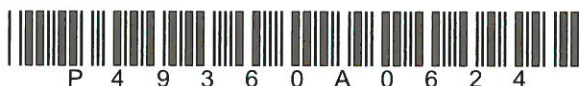

9 Here is a map of an island.

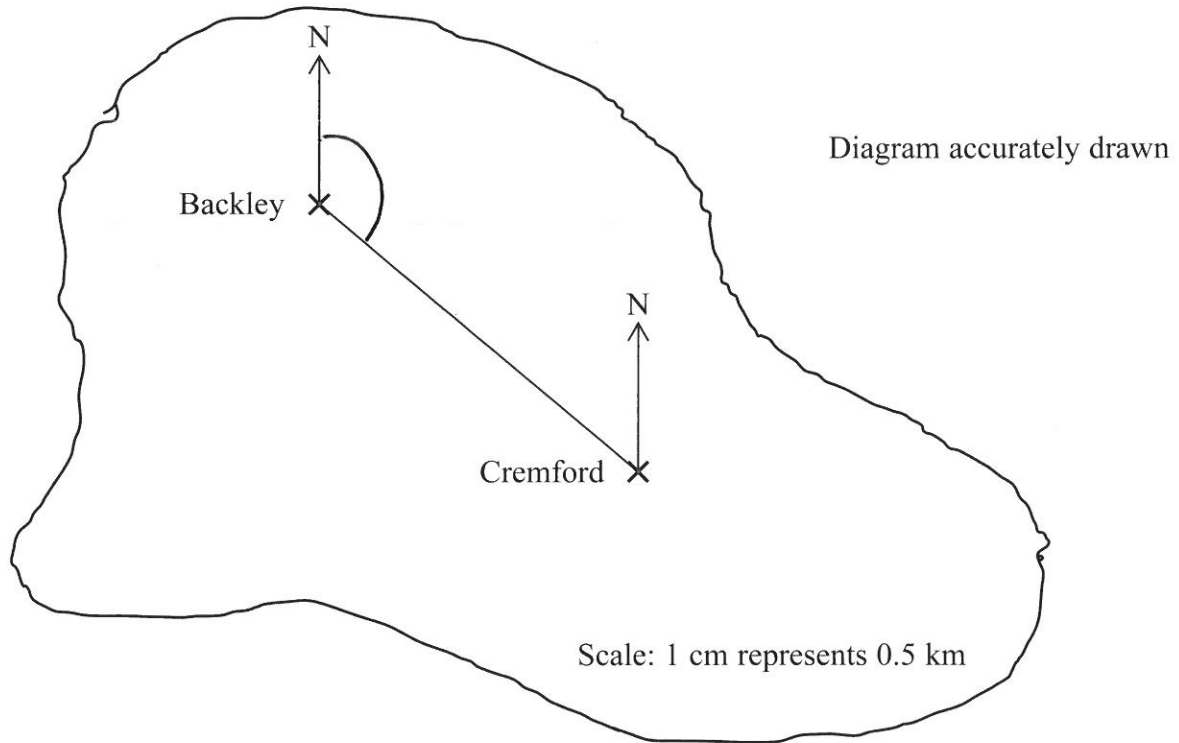

A straight road joins the two villages, Backley and Cremford.

(a) Work out the real distance between the two villages.

$$5.5 \text{ cm} \quad 5.5 \times 0.5$$

$$\underline{2.75} \text{ km}$$

(2)

(b) Find the bearing of Cremford from Backley.

$$\underline{130}^\circ$$

(1)

(Total for Question 9 is 3 marks)



10 The diagram shows two shapes drawn on a centimetre grid.

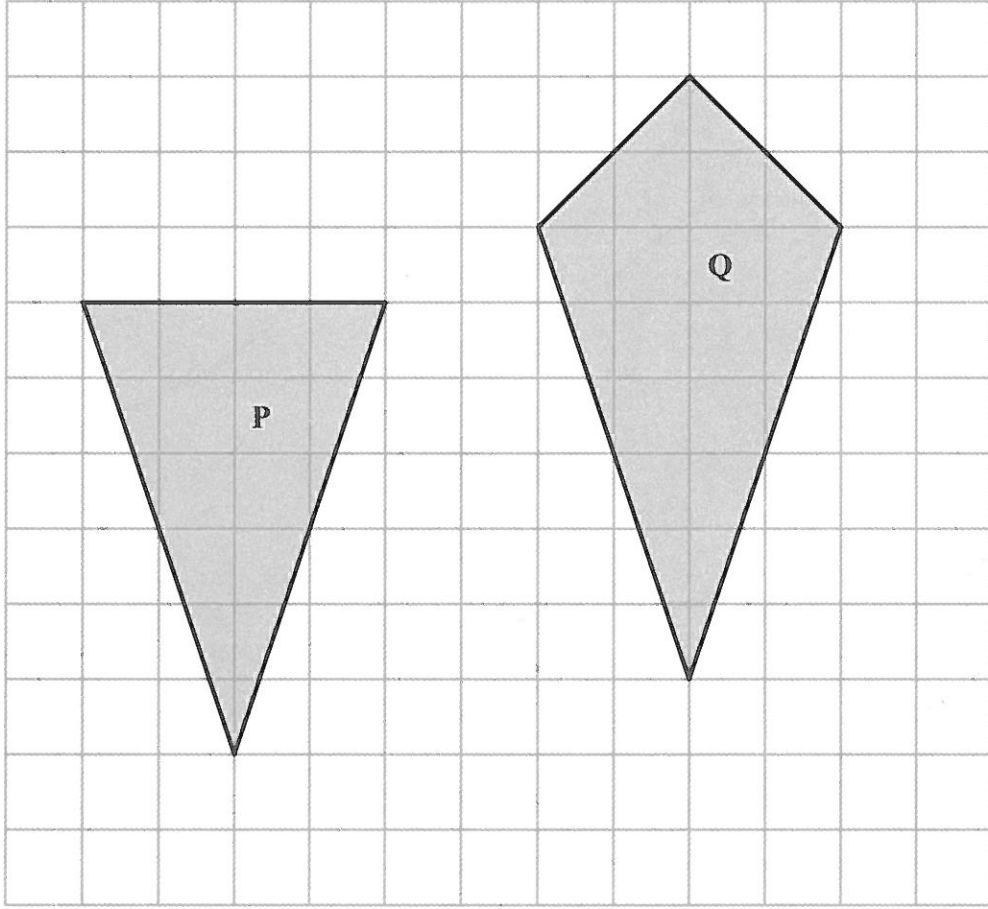

(a) Find the area of shape P.

$$\frac{1}{2} \times 4 \times 6$$

12 cm<sup>2</sup>  
.....  
(2)

(b) Write down the mathematical name of quadrilateral Q.

KITE  
.....  
(1)

(Total for Question 10 is 3 marks)





11 The table shows a cricket club's income in 2016 from a fete, a quiz and membership fees.

		Income	
Fete		£250	
Quiz	Entry fees	13	at £5 each
	Refreshments	£35	
Membership fees		25	at £20 each

$$5 \times 13 = 65$$

$$65 + 35 = 100$$

$$25 \times 20 = 500$$

Express as a ratio

the income from the fete to the income from the quiz to the income from membership fees.

Give your ratio in its simplest form.

$$250 : 100 : 500$$

$$\div 50 \downarrow$$

$$5 : 2 : 10$$

$$5 : 2 : 10$$

(Total for Question 11 is 3 marks)



12 200 people live in a village.

23 people do **not** have a garden.

10 males do **not** have a garden.

95 people are male.

(a) Use this information to complete the frequency tree.

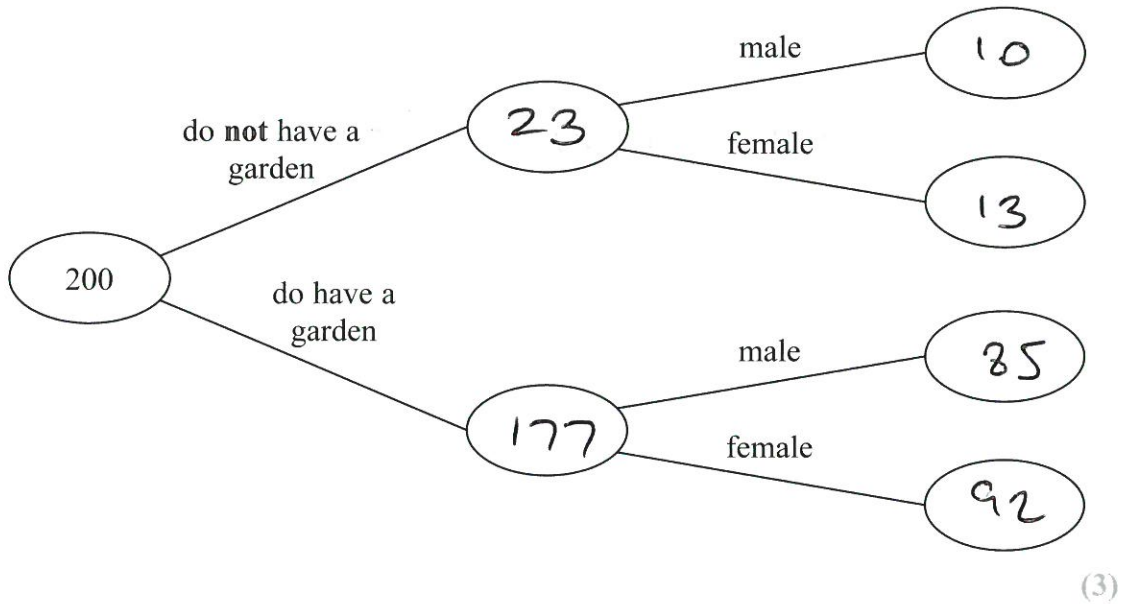

One of the people who does **not** have a garden is chosen at random.

(b) Write down the probability that this person is female.

$$\frac{13}{23}$$

(2)

(Total for Question 12 is 5 marks)



13 Ellie makes hats.

She makes at least 17 hats per hour.

She is paid 46p for each hat she makes.

$$17 \times 46 = 782p \text{ PER HOUR}$$

Reaze is a waiter.

He works 35 hours and is paid a total of £266

$$266 \div 35 = \text{£}7.60 = 760p \text{ PER HOUR}$$

Show that Ellie's hourly rate of pay is more than Reaze's hourly rate of pay.

$\therefore$  ELLIE'S HOURLY RATE IS 22p PER HOUR MORE

(Total for Question 13 is 3 marks)



14  $a$  and  $b$  are odd numbers.

(a) Give an example to show that the value of  $2(a + b)$  is a multiple of 4

$$a = 3$$

$$b = 5$$

$$a + b = 3 + 5 = 8$$

$$2 \times 8 = 16$$

16 is a multiple of 4  
(IT IS IN THE 4 TIMES TABLE)

(2)

(b) Show that, when  $a$  and  $b$  are both odd numbers, the value of  $2(a + b)$  will always be a multiple of 4

$$\text{ODD} + \text{ODD} = \text{EVEN} = 2 \text{ TIMES TABLE}$$

$$2 \times \text{EVEN} = 4 \text{ TIMES TABLE}$$

(2)

(Total for Question 14 is 4 marks)



15 Mr Page uses oil to heat his home.

At the beginning of November there were 1000 litres of oil in his oil tank.

Mr Page bought enough oil to fill the tank completely.

He paid 50p per litre for this oil.

He paid a total amount of £750

At the end of February Mr Page had 600 litres of oil in the tank.

He bought enough oil to fill the tank completely.

The cost of oil had increased by 4%.

Work out the total amount Mr Page paid for the oil he bought in February.

NOVEMBER: PAID £750 AND PRICE = 50p PER LITRE  
∴ BOUGHT 1500 LITRES

THERE WERE ALREADY 1000 LITRES IN HIS TANK  
∴ TANK HOLDS 2500 LITRES

FEBRUARY: 600 LITRES IN TANK ∴ NEEDS TO BUY  
1900 LITRES

NEW PRICE =  $1.04 \times 50 = 52p$  PER LITRE

∴ SPENDS  $1900 \times 52 = 98800p$   
 $= £988$

£ 988

(Total for Question 15 is 5 marks)



P 4 9 3 6 0 A 0 1 3 2 4

16 Solve  $5x - 6 = 3(x - 1)$

$$5x - 6 = 3x - 3$$

$$2x = 3$$

$$x = 3/2$$

(or  $1\frac{1}{2}$  or 1.5)

$$x = \frac{3}{2}$$

(Total for Question 16 is 3 marks)

17 Emily buys a pack of 12 bottles of water.

The pack costs £5.64

Emily sells all 12 bottles for 50p each.  $12 \times 50p = \pounds 6$

Work out Emily's percentage profit.

Give your answer correct to 1 decimal place.

$$\text{Profit} = 6 - 5.64 = 36p \text{ PER BOTTLE}$$

$$\% \text{ profit} = \frac{36}{564} \times 100 = 6.38298$$

$$6.4 \%$$

(Total for Question 17 is 3 marks)



18 Hasmeeth walks once round a circle with diameter 80 metres.

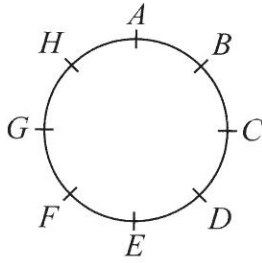

There are 8 points equally spaced on the circumference of the circle.

(a) Find the distance Hasmeeth walks between one point and the next point.

$$C = \pi d = \pi \times 80$$

$$\therefore \text{DISTANCE BETWEEN POINTS} = \frac{\pi \times 80}{8} = \pi \times 10$$

$$\dots\dots\dots 31.4 \dots\dots m$$

(2)

Four of the points are moved, as shown in the diagram below.

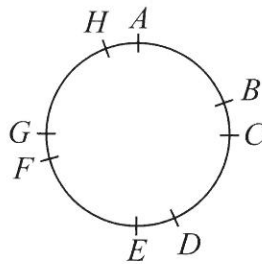

Hasmeeth walks once round the circle again.

(b) Has the mean distance that Hasmeeth walks between one point and the next point changed? You must give a reason for your answer.

NO - TOTAL DISTANCE IS THE SAME AND NUMBER OF POINTS IS THE SAME  $\therefore$  MEAN IS SAME

(1)

(Total for Question 18 is 3 marks)



19 There are only blue cubes, yellow cubes and green cubes in a bag.

There are

twice as many blue cubes as yellow cubes  
and four times as many green cubes as blue cubes.

Hannah takes at random a cube from the bag.

Work out the probability that Hannah takes a yellow cube.

SUPPOSE 1 YELLOW  
2 BLUE  
8 GREEN  
-----  
11

$\frac{1}{11}$

(Total for Question 19 is 3 marks)

DO NOT WRITE IN THIS AREA

DO NOT WRITE IN THIS AREA

DO NOT WRITE IN THIS AREA





DO NOT WRITE IN THIS AREA

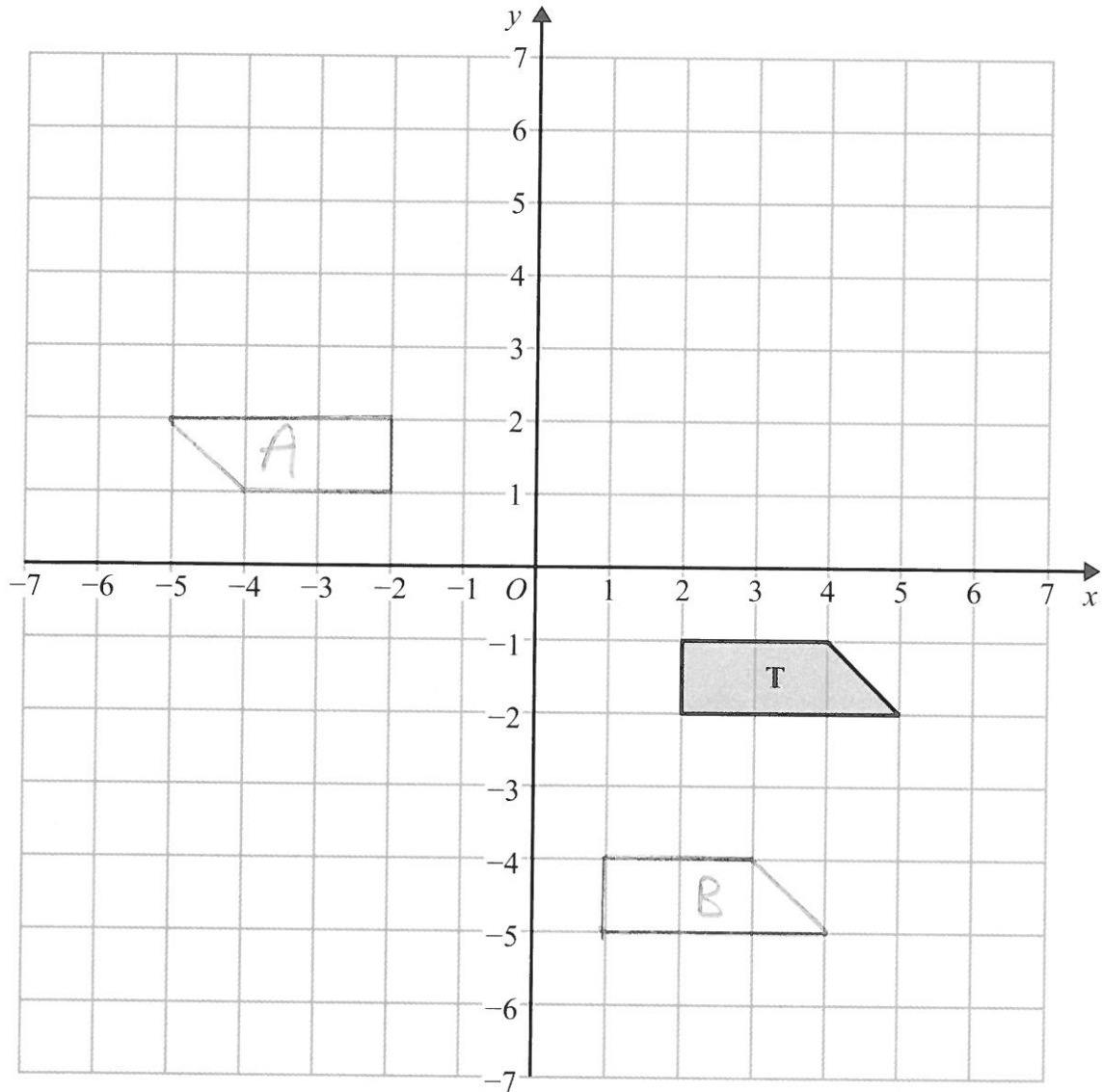

(a) Rotate trapezium T  $180^\circ$  about the origin.  
Label the new trapezium A.

(1)

(b) Translate trapezium T by the vector  $\begin{pmatrix} -1 \\ -3 \end{pmatrix}$   
Label the new trapezium B.

(1)

(Total for Question 20 is 2 marks)



21  $p^3 \times p^x = p^9$

(a) Find the value of  $x$ .

$$3 + x = 9$$

$$x = \frac{6}{(1)}$$

$$(7^2)^y = 7^{10}$$

(b) Find the value of  $y$ .

$$2y = 10$$

$$y = \frac{5}{(1)}$$

$100^a \times 1000^b$  can be written in the form  $10^w$

(c) Show that  $w = 2a + 3b$

$$\begin{aligned} 100 &= 10^2 \\ \therefore 100^a &= (10^2)^a = 10^{2a} \\ 1000 &= 10^3 \\ \therefore 1000^b &= (10^3)^b = 10^{3b} \\ \therefore 10^{2a} \times 10^{3b} &= 10^w \\ \therefore 2a + 3b &= w \end{aligned} \tag{2}$$

(Total for Question 21 is 4 marks)



22  $ABCD$  is a trapezium.

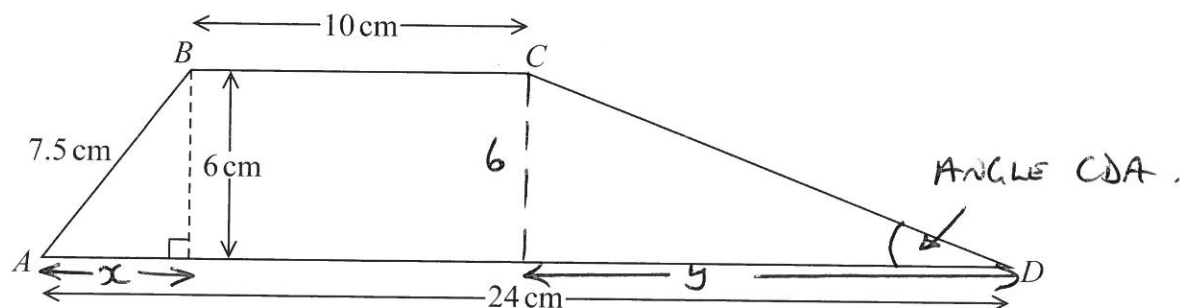

Work out the size of angle  $CDA$ .

Give your answer correct to 1 decimal place.

$$x^2 = 7.5^2 - 6^2 = 20.25$$

$$\therefore x = \sqrt{20.25} = 4.5 \text{ cm}$$

$$\therefore y = 24 - 4.5 - 10 = 9.5 \text{ cm}$$

$$\tan CDA = \frac{6}{9.5}$$

$$\begin{aligned} \therefore CDA &= \tan^{-1}\left(\frac{6}{9.5}\right) \\ &= 32.3^\circ \end{aligned}$$

32.3°

(Total for Question 22 is 5 marks)



P 4 9 3 6 0 A 0 1 9 2 4

23 Use your calculator to work out  $\sqrt{\frac{\sin 25^\circ + \sin 40^\circ}{\cos 25^\circ - \cos 40^\circ}}$

$$\sqrt{\frac{1.065405871}{0.140263343}}$$

(a) Write down all the figures on your calculator display.

2.75603957

(2)

(b) Write your answer to part (a) correct to 2 decimal places.

2.76

(1)

(Total for Question 23 is 3 marks)

DO NOT WRITE IN THIS AREA

DO NOT WRITE IN THIS AREA

DO NOT WRITE IN THIS AREA



DO NOT WRITE IN THIS AREA

24 (a) Solve  $2x^2 = 72$

$$x^2 = 36$$

$$x = \pm 6$$

$$\underline{x = \pm 6} \quad (2)$$

(b) Expand and simplify  $(2x + 1)(3x - 2)$

$$\begin{aligned} & 6x^2 - 4x + 3x - 2 \\ = & 6x^2 - x - 2 \end{aligned}$$

$$\underline{6x^2 - x - 2} \quad (2)$$

(c) Factorise  $x^2 + 6x + 9$

$$(x + 3)(x + 3)$$

$$\begin{aligned} & \underline{(x + 3)(x + 3)} \\ & \text{(or } (x + 3)^2 \text{)} \quad (1) \end{aligned}$$

(Total for Question 24 is 5 marks)

TOTAL FOR PAPER IS 80 MARKS



DO NOT WRITE IN THIS AREA

DO NOT WRITE IN THIS AREA

DO NOT WRITE IN THIS AREA

BLANK PAGE



DO NOT WRITE IN THIS AREA

DO NOT WRITE IN THIS AREA

DO NOT WRITE IN THIS AREA

**BLANK PAGE**



P 4 9 3 6 0 A 0 2 3 2 4

DO NOT WRITE IN THIS AREA

DO NOT WRITE IN THIS AREA

DO NOT WRITE IN THIS AREA

BLANK PAGE

