

Please check the examination details below before entering your candidate information

Candidate surname

Other names

Centre Number

Candidate Number

Pearson Edexcel

Level 1/Level 2 GCSE (9–1)

**Tuesday 21 May 2019**

Morning (Time: 1 hour 30 minutes)

Paper Reference **1MA1/1F****Mathematics****Paper 1 (Non-Calculator)****Foundation Tier**

**You must have:** Ruler graduated in centimetres and millimetres, protractor, pair of compasses, pen, HB pencil, eraser.  
Tracing paper may be used.

Total Marks

**Instructions**

- Use **black** ink or ball-point pen.
- **Fill in the boxes** at the top of this page with your name, centre number and candidate number.
- Answer **all** questions.
- Answer the questions in the spaces provided  
– *there may be more space than you need.*
- You must **show all your working**.
- Diagrams are **NOT** accurately drawn, unless otherwise indicated.
- **Calculators may not be used.**

**Information**

- The total mark for this paper is 80
- The marks for **each** question are shown in brackets  
– *use this as a guide as to how much time to spend on each question.*

**Advice**

- Read each question carefully before you start to answer it.
- Keep an eye on the time.
- Try to answer every question.
- Check your answers if you have time at the end.

Turn over ►

P54155A

©2019 Pearson Education Ltd.

6/7/11/1/1/1

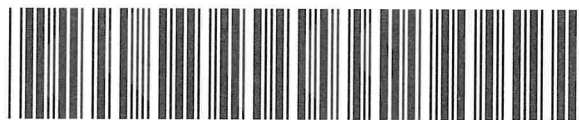

P 5 4 1 5 5 A 0 1 2 4



Pearson

Answer ALL questions.

Write your answers in the spaces provided.

You must write down all the stages in your working.

- 1 Write 180 minutes in hours.

$$3 \times 60 = 180$$

..... 3 hours

(Total for Question 1 is 1 mark)

- 2 Write 0.73 as a percentage.

$$0.73 \times 100$$

..... 73 %

(Total for Question 2 is 1 mark)

- 3 Work out  $10 \times (3 + 5)$

$$10 \times 8$$

..... 80

(Total for Question 3 is 1 mark)

- 4 Write down a prime number that is between 20 and 30

..... 23 (or 29)

(Total for Question 4 is 1 mark)

DO NOT WRITE IN THIS AREA



- 5 Find the number that is exactly halfway between 7 and 15

$$7 + 15 = 22$$

$$\frac{1}{2} \times 22 = 11$$

11

(Total for Question 5 is 1 mark)

- 6 Harry is planning a holiday for 4 people for 7 days.

Here are the costs for the holiday for **each person**.

Travel	£150
Hotel	£50 for each day $\times 7 = 350$
Spending money	£250

Work out the total cost of the holiday for 4 people for 7 days.

$$150 + 350 + 250 = 750$$

$$750 \times 4 = 3000.$$

£ 3000

(Total for Question 6 is 4 marks)



P 5 4 1 5 5 A 0 3 2 4

- 7 In Adam's garden, the flowers are only red or white or yellow or blue.

The chart shows the number of red flowers, the number of white flowers and the number of yellow flowers.

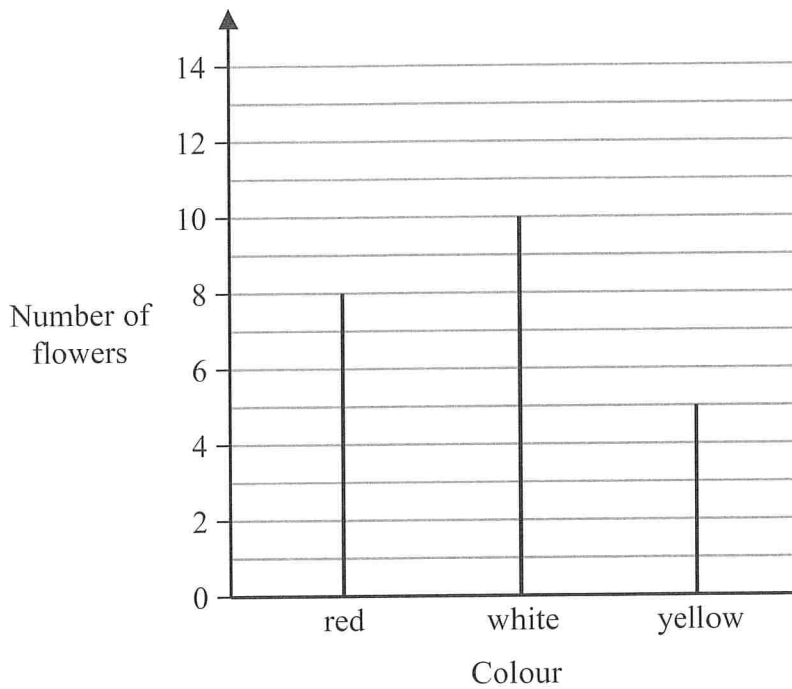

The total number of flowers is 30

- (a) Work out the number of blue flowers.

$$8 + 10 + 5 = 23$$

$$30 - 23 = 7$$

7  
(2)

- (b) Write down the mode.

WHITE  
(1)

(Total for Question 7 is 3 marks)



- 8 Write the following fractions in order of size.  
Start with the smallest fraction.

$$\frac{1}{3} \quad \frac{3}{4} \quad \frac{1}{4} \quad \frac{7}{12} \quad \frac{1}{2}$$
$$\frac{4}{12} \quad \frac{9}{12} \quad \frac{3}{12} \quad \frac{7}{12} \quad \frac{6}{12}$$

$$\frac{1}{4}, \frac{1}{3}, \frac{1}{2}, \frac{7}{12}, \frac{3}{4}$$

(Total for Question 8 is 2 marks)

- 9 Ruth left her home at 9 am and walked to the library. She got to the library at 1030 am. Ruth walked at a speed of 4 mph.

$1\frac{1}{2}$  HOURS

- (a) Work out the distance Ruth walked.

$$4 \times 1\frac{1}{2} = 6$$

6 miles  
(2)

Ruth got to the library at 1030 am.  
She stayed at the library for 50 minutes.  
Then she walked home.

Ruth took  $1\frac{1}{4}$  hours to walk home.

- (b) At what time did Ruth get home?

$$10:30 + 50 \text{ MINS} = 11:20$$
$$11:20 + 1 \text{ HR } 15 \text{ MINS} = 12:35,$$

12:35 pm.  
(2)

(Total for Question 9 is 4 marks)



10 (a) Solve  $t + t + t = 12$

$$3t = 12$$

$$t = \frac{12}{3}$$

$$t = 4$$

$$t = \underline{4} \quad (1)$$

(b) Solve  $x - 2 = 6$

$$x = 6 + 2$$

$$x = \underline{8} \quad (1)$$

(c) Solve  $6w + 2 = 20$

$$6w = 20 - 2 = 18$$

$$w = \frac{18}{6}$$

$$w = \underline{3} \quad (2)$$

(Total for Question 10 is 4 marks)

DO NOT WRITE IN THIS AREA

DO NOT WRITE IN THIS AREA

DO NOT WRITE IN THIS AREA



11 Work out  $74 \times 58$

$$\begin{array}{r} 74 \\ \times 58 \\ \hline 592 \\ \phantom{592} 3 \\ 3700 \\ \hline 4292 \end{array}$$

4292

(Total for Question 11 is 2 marks)



12  $AB$  and  $BC$  are perpendicular lines.

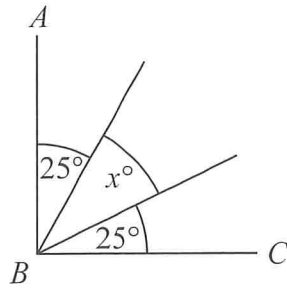

(a) Find the value of  $x$ .

$$90 - 25 - 25$$

$$x = 40^\circ \quad (2)$$

$RS$  and  $TU$  are parallel lines.

$PQ$  is a straight line.

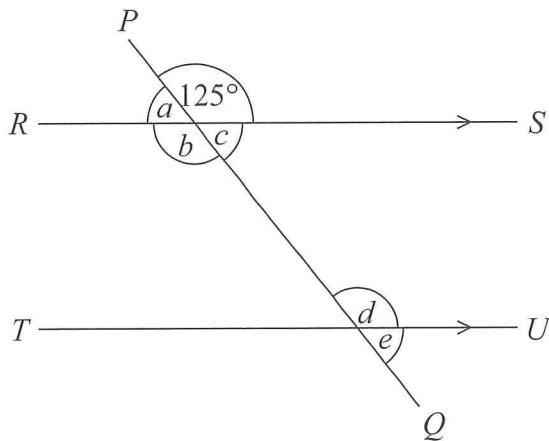

An angle of size  $125^\circ$  is shown on the diagram.

(b) (i) Write down the letter of one other angle of size  $125^\circ$   
Give a reason for your answer.

$d$  CORRESPONDING ANGLES

(or  $b$  VERTICALLY OPPOSITE ANGLES)

(2)

(ii) Explain why  $a + b + c = 235^\circ$

$$a + b + c = 360 - 125 = 235$$

BECAUSE AT A POINT ADD UP TO  $360^\circ$

(1)

(Total for Question 12 is 5 marks)





13 The length of a line is  $x$  centimetres.

Write down an expression, in terms of  $x$ , for the length of the line in millimetres.

$$1 \text{ cm} = 10 \text{ mm}$$

$$10x$$

(Total for Question 13 is 1 mark)

14 (a) Work out  $\frac{1}{5}$  of 70

$$70 \div 5$$

$$14$$

(1)

Fiona has to work out the exact value of  $48 \div \frac{1}{2}$

She writes

$$48 \div \frac{1}{2} = 24$$

Fiona's reason is,

“There are 2 halves in 1, so there will be 24 halves in 48”

(b) Explain what is wrong with Fiona's reason.

$$48 \div \frac{1}{2} = 48 \times \frac{2}{1} = 96$$

THERE ARE 96 HALVES IN 48

(1)

(Total for Question 14 is 2 marks)



15 (a) Write down the value of  $\sqrt{64}$

$$8 \times 8 = 64$$

8  
-----  
(1)

(b) Work out the value of  $5^3$

$$5 \times 5 \times 5$$

125  
-----  
(1)

(Total for Question 15 is 2 marks)

16 (a) Expand  $5(2m - 3)$

$$10m - 15$$

10m - 15  
-----  
(1)

(b) Factorise  $3n + 12$

$$3(n + 4)$$

3(n + 4)  
-----  
(1)

(Total for Question 16 is 2 marks)



17 Stuart throws a biased coin 10 times.  
He gets 7 Tails.

Maxine throws the same coin 50 times.  
She gets 30 Tails.

Prasha is going to throw the coin once.

- (i) Whose results will give the better estimate for the probability that she will get Tails, Stuart's or Maxine's?  
You must give a reason for your answer.

MAXINE - THROWS THE COIN MORE TIMES

(1)

- (ii) Use Stuart's and Maxine's results to work out an estimate for the probability that Prasha will get Tails.

TOTAL OF 37 TAILS OUT OF 60 THROWS

$$\frac{37}{60}$$

(1)

(Total for Question 17 is 2 marks)



18 The diagram shows a rectangular garden path.

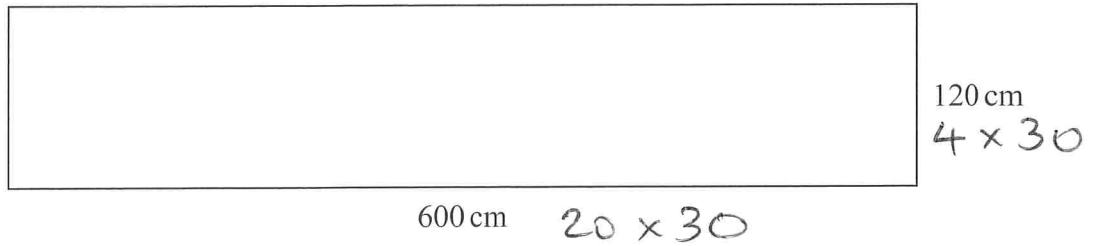

Wasim is going to cover the path with paving stones.

Each paving stone is a square of side 30 cm.

Each paving stone costs £2.50

Wasim has £220 to spend on paving stones.

Show that he has enough money to buy all the paving stones he needs.

$$\text{NEEDS } 20 \times 4 = 80 \text{ STONES}$$

$$80 \times 2.50 = 160 + 40 = \pounds 200.$$

WASIM HAS  $\pounds 220$  SO HAS  $\pounds 20$  TO SPARE

(Total for Question 18 is 4 marks)



19 (a) Work out  $\frac{2}{3} - \frac{1}{5}$

$$\frac{10-3}{15} = \frac{7}{15}$$

$$\frac{7}{15}$$

(2)

(b) Work out  $\frac{2}{3} \times \frac{3}{4}$

Give your answer as a fraction in its simplest form.

$$\frac{6}{12} = \frac{1}{2}$$

$$\frac{1}{2}$$

(2)

(Total for Question 19 is 4 marks)



20 Here are two squares, A and B.

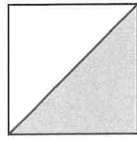

A

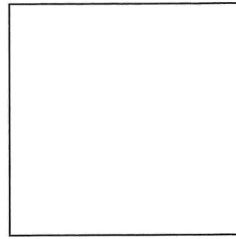

B

The length of the side of square A is 50% of the length of the side of square B.

Express the area of the shaded region of square A as a percentage of the area of square B.

$$50\% = \frac{1}{2}$$

$$\frac{1}{2} \times \frac{1}{2} = \frac{1}{4} \quad \text{So AREA OF A} = \frac{1}{4} \text{ AREA OF B}$$

$$\text{SHADED AREA} = \frac{1}{2} \text{ AREA OF A}$$

$$\therefore \text{SHADED AREA} = \frac{1}{2} \times \frac{1}{4} = \frac{1}{8} \text{ AREA OF B}$$

$$\frac{1}{2} \times 25\% = 12.5\%$$

12.5 %

(Total for Question 20 is 3 marks)



- 21 There are 40 students in a class.  
Each student walks to school or cycles to school or gets the bus to school.

There are 22 girls in the class.  
9 of the girls walk to school.  
7 of the boys cycle to school.  
6 of the 10 students who get the bus to school are boys.

Find the number of these students who walk to school.

	WALK	CYCLE	BUS	
Girl	9	9	4	22
Boy	5	7	6	18
	14	16	10	40

14

(Total for Question 21 is 4 marks)



22 There are only blue cubes, red cubes and yellow cubes in a box.

The table shows the probability of taking at random a blue cube from the box.

Colour	blue	red	yellow
Probability	0.2	0.4	0.4

The number of red cubes in the box is the same as the number of yellow cubes in the box.

(a) Complete the table.

$$1 - 0.2 = 0.8$$

$$0.8 \div 2 = 0.4$$

(2)

There are 12 blue cubes in the box.

(b) Work out the total number of cubes in the box.

$$0.2 \rightarrow 12$$

$$5 \times 0.2 \rightarrow 5 \times 12$$

$$= 1 \quad = 60.$$

60

(2)

(Total for Question 22 is 4 marks)





23 Deon needs 50 g of sugar to make 15 biscuits.

She also needs

three times as much flour as sugar  $3 \times 50 = 150$   
two times as much butter as sugar  $2 \times 50 = 100$ ,

Deon is going to make 60 biscuits.

(a) Work out the amount of flour she needs.

$$60 = 15 \times 4,$$
$$150 \times 4 = 600$$

$$\begin{array}{r} 600 \text{ g} \\ \hline (3) \end{array}$$

Deon has to buy all the butter she needs to make 60 biscuits.  
She buys the butter in 250 g packs.

(b) How many packs of butter does Deon need to buy?

$$100 \times 4 = 400$$
$$\frac{400}{250} = \frac{40}{25} = \frac{8}{5} = 1.6 \rightarrow 2$$

$$\begin{array}{r} 2 \\ \hline (2) \end{array}$$

(Total for Question 23 is 5 marks)



24 Find the highest common factor (HCF) of 72 and 90

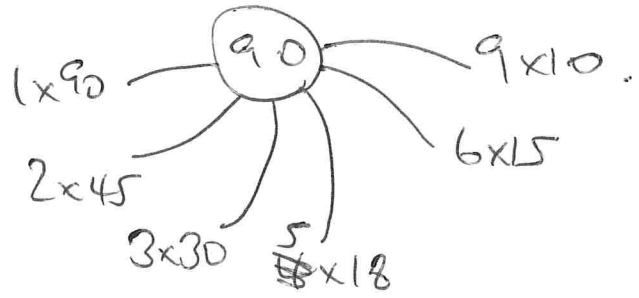
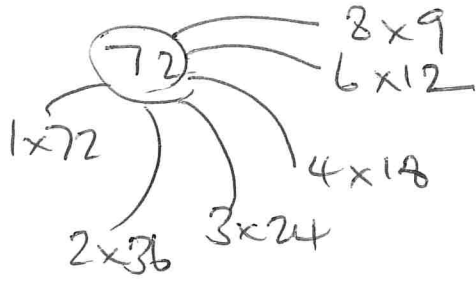

18

(Total for Question 24 is 2 marks)

DO NOT WRITE IN THIS AREA

DO NOT WRITE IN THIS AREA

DO NOT WRITE IN THIS AREA



25 The diagram shows the plan, front elevation and side elevation of a solid shape, drawn on a centimetre grid.

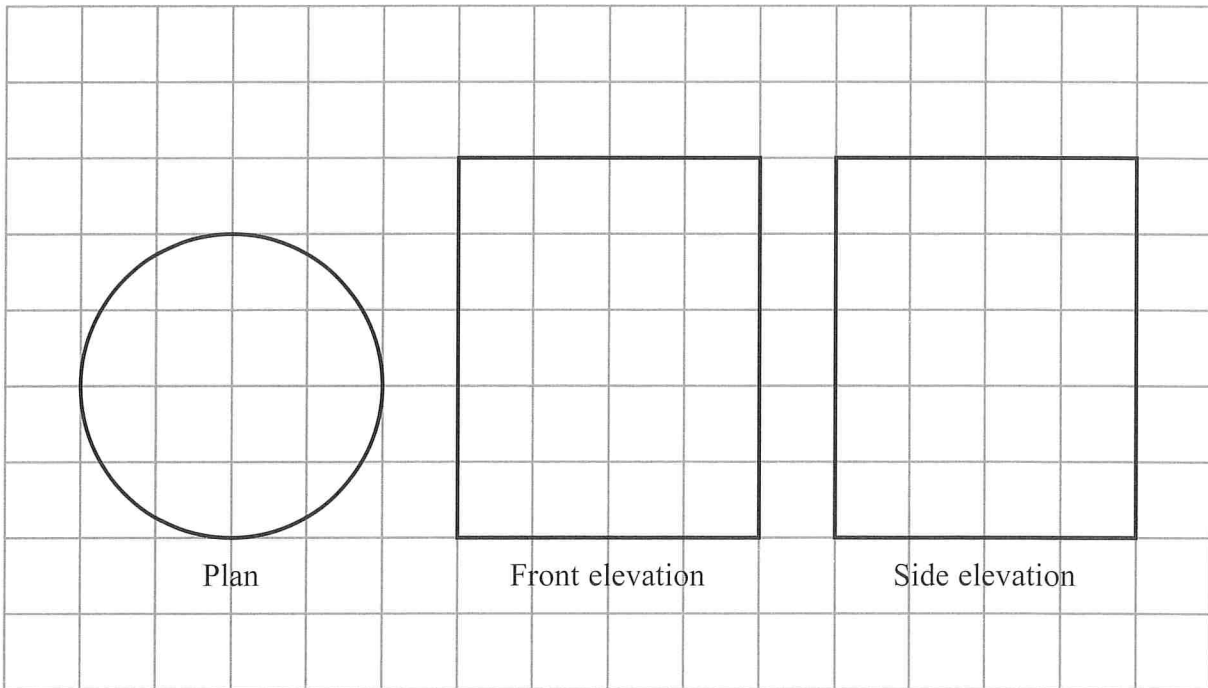

In the space below, draw a sketch of the solid shape.  
Give the dimensions of the solid on your sketch.

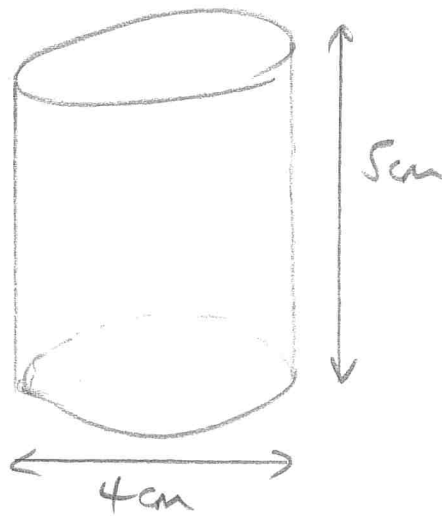

(Total for Question 25 is 2 marks)



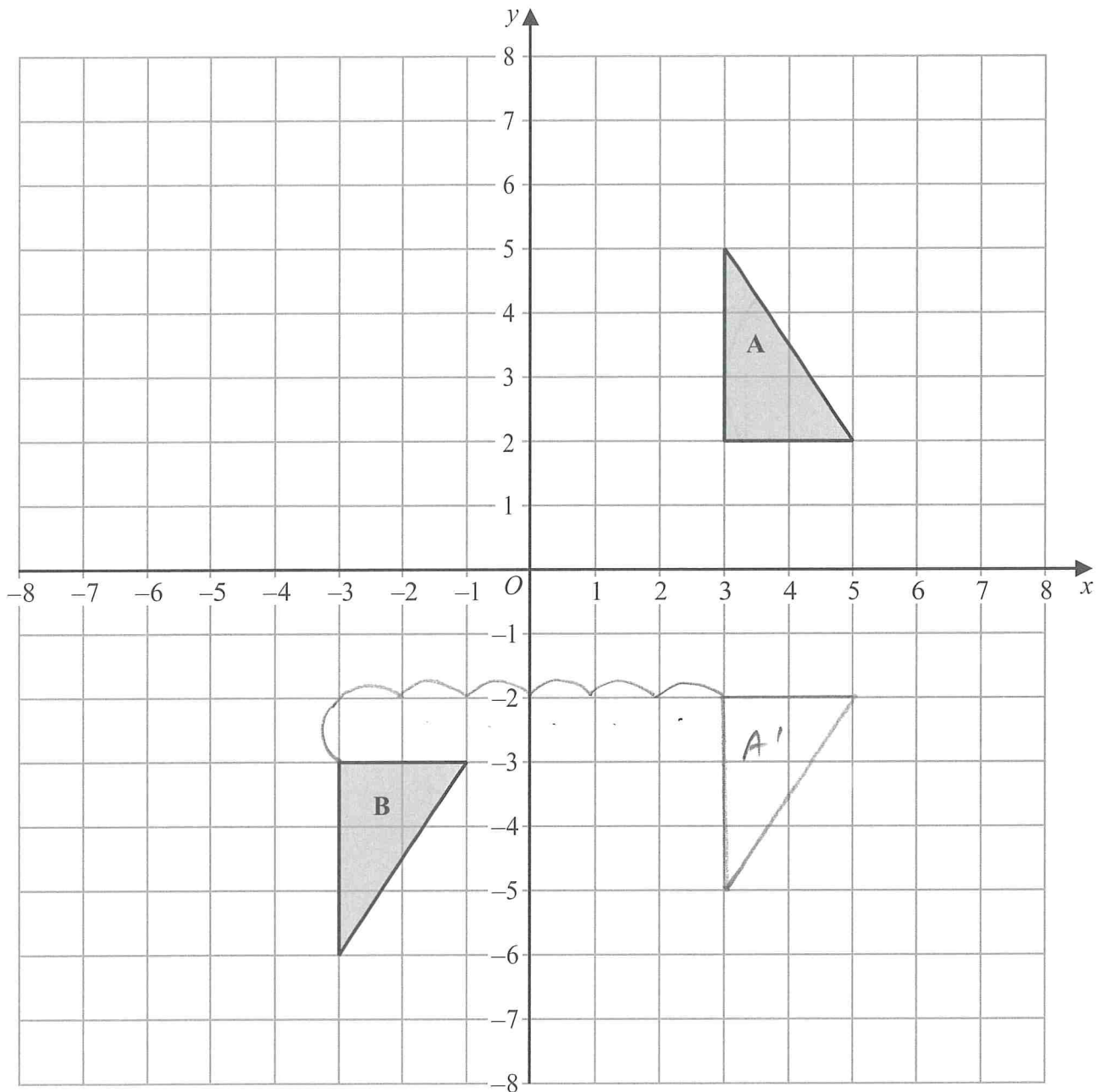

Shape **A** can be transformed to shape **B** by a reflection in the  $x$ -axis followed by a translation  $\begin{pmatrix} c \\ d \end{pmatrix}$

Find the value of  $c$  and the value of  $d$ .

$$c = -6$$

$$d = -1$$

(Total for Question 26 is 3 marks)



27 A shop sells packs of black pens, packs of red pens and packs of green pens.

There are

2 pens in each pack of black pens

5 pens in each pack of red pens

6 pens in each pack of green pens

On Monday,

number of packs of black pens sold : number of packs of red pens sold : number of packs of green pens sold = 7:3:4

A total of 212 pens were sold.

Work out the number of green pens sold.

$$\text{NUMBER OF BLACK PENS} = 7 \times 2 = 14,$$

$$\text{NUMBER OF RED PENS} = 3 \times 5 = 15$$

$$\text{NUMBER OF GREEN PENS} = 4 \times 6 = 24,$$

$$\hline 53$$

$$\frac{212}{53} = 4,$$

$$\therefore \text{NUMBER OF GREEN PENS SOLD} = 4 \times 24 = 96,$$

96

(Total for Question 27 is 4 marks)



28 Here are two rectangles.

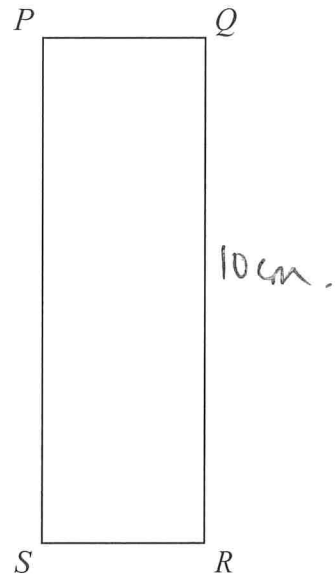
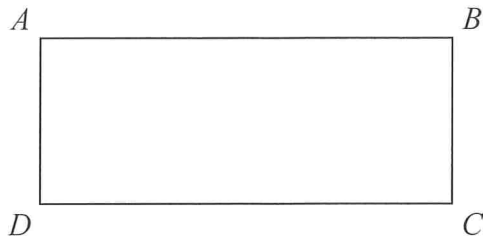

$$QR = 10 \text{ cm}$$

$$BC = PQ$$

The perimeter of  $ABCD$  is 26 cm  
 The area of  $PQRS$  is  $45 \text{ cm}^2$

Find the length of  $AB$ .

$$PQRS : \text{ AREA} = PQ \times QR = PQ \times 10 = 45$$

$$\therefore PQ = \frac{45}{10} = 4.5 \text{ cm.}$$

$$BC = PQ = 4.5 \text{ cm.}$$

$$\underbrace{AB + DC} + \underbrace{AD + BC} = 26$$

$$2AD + 2BC = 26$$

$$2AB + 2 \times 4.5 = 26$$

$$2AB = 26 - 9 = 17$$

$$AB = \frac{17}{2} = 8.5$$

..... 8.5 cm

(Total for Question 28 is 4 marks)



29 Here is the graph of  $y = x^2 - 2x - 3$

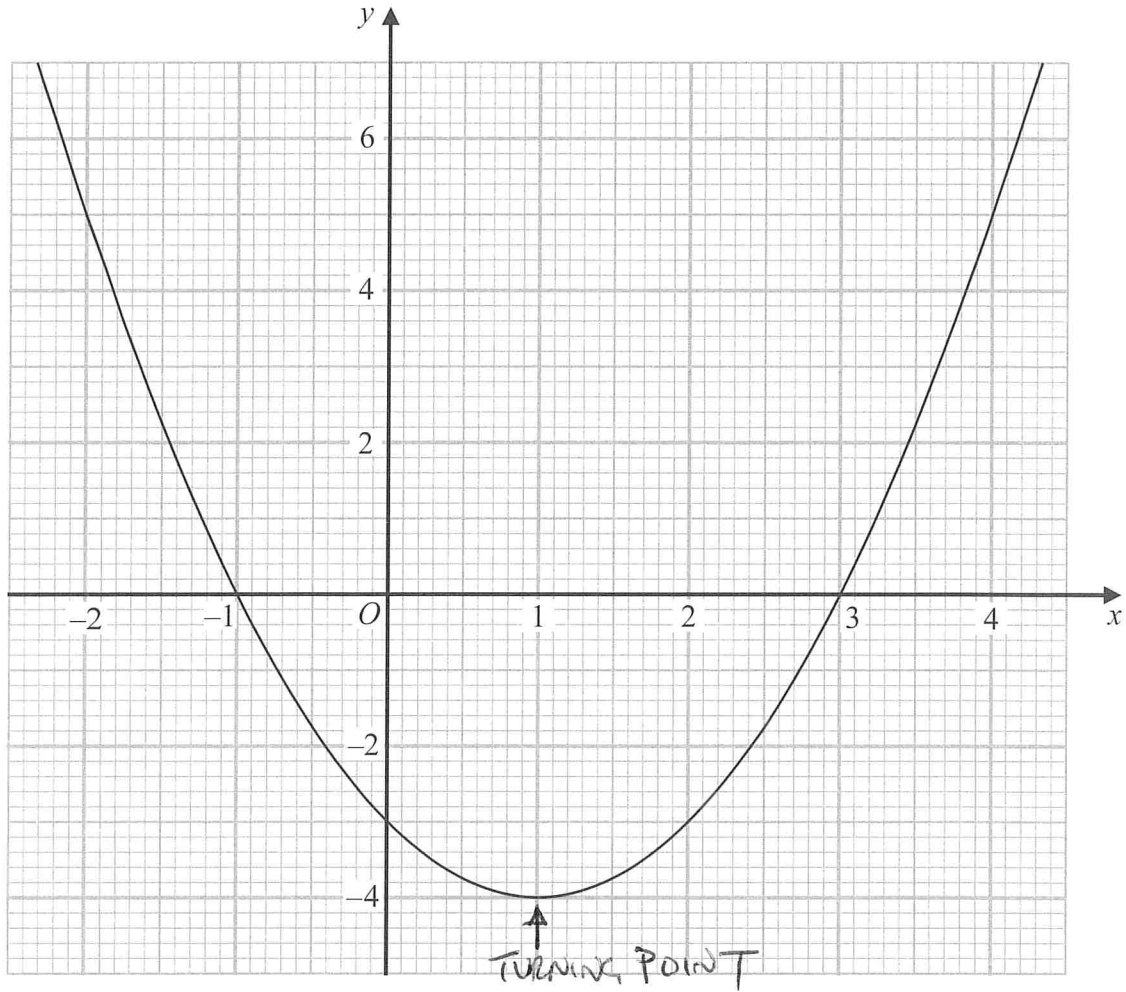

(a) Write down the coordinates of the turning point on the graph of  $y = x^2 - 2x - 3$

(1, -4)  
(1)

(b) Use the graph to find the roots of the equation  $x^2 - 2x - 3 = 0$

↑  
WHERE IT  
CROSSES THE  
x AXIS

$x = -1, 3$   
(2)

(Total for Question 29 is 3 marks)

TOTAL FOR PAPER IS 80 MARKS



DO NOT WRITE IN THIS AREA

DO NOT WRITE IN THIS AREA

DO NOT WRITE IN THIS AREA

**BLANK PAGE**

