

Paper 2 and Paper 3 Preparation Paper

Edexcel Foundation



Corbettmaths

Ensure you have: Pencil, pen, ruler, protractor, pair of compasses and eraser

You will need a calculator

Guidance

1. Read each question carefully before you begin answering it.
2. Check your answers seem right.
3. Always show your workings

Revision for this test

www.corbettmaths.com/contents



Question	Topic	Video number
1	Cube Numbers and Cube Roots	212, 214
2	LCM	218, 219
3	Angles in a Triangle	37
4	Angles in a Quadrilateral	33
5	Symmetry	316, 317
6	Nets	4
7	Mode, Median, Range, Mean	56, 50, 53, 57
8	Types of Angle	38
9	Prime numbers	225
10	Square numbers	226
11	Product of primes	223
12	Fractions of Amounts	137
13	Scatter Graphs	165 to 168
14	Pictograms	161, 162
15	Units	347, 349
16	Angles in Polygons	32
17	Angle Facts (triangle)	35, 30, 34, 39
18	Estimated Mean	55
19	Tree Diagrams	252
20	Currency	214a
21	Reverse Percentages	240
22	Expanding Two Brackets	14
23	nth term	288
24	Factorising	117
25	Factorising Quadratics	118
26	Solving Inequalities	178
27	Conversion Graphs	151
28	Difference between 2 Squares	120
29	Compound Interest	236
30	Standard Form (operations)	301, 302, 303

Question	Topic	Video number
31	Constructions	72, 78
32	Loci	75, 76, 77
33	Volume of a Prism	356
34	Enlargements	104, 105, 107
35	Circumference	60
36	Area of Compound Shapes	41
37	Volume of a Cylinder	357
38	Trigonometry	329, 330, 331
39	Rotations	275
40	Similar Shapes	292
41	Simultaneous Equations	295
42	Changing the Subject	7
43	Forming Equations	114, 115
44	Pie Charts	163, 164
45	Pythagoras	257
46	Area of a Circle	59
47	Bearings	26, 27
48	Place Value	222
49	Negative Numbers	205 to 209
50	Function Machines	386
51	Coordinates	84
52	Writing Expressions	16
53	Faces, Edges, Vertices	5, 3
54	Timetables	320
55	Distance Charts	318
56	Line Graphs	160
57	Frequency Polygons	155, 156
58	Listing Outcomes	253

Question	Topic	Video number
59	Stem and Leaf	169, 170
60	Rounding	276, 277a, 277b, 278
61	Percentages of Amounts	234, 235
62	Ratio	269, 270, 271
63	Frequency Trees	376
64	Area of Triangles	49
65	Venn Diagrams	380
66	Ratio	269, 270, 271
67	Negative Indices	175
68	Equations (letters both sides)	113
69	$y = mx + c$	191
70	Cubic Graphs	344
71	Reciprocal Graph	346
72	Density	384
73	Pressure	385
74	Volume of Spheres/Cones	359, 361
75	Vectors (Columns)	353a
76	Congruent Triangles	67
77	Parallel Graphs	196
78	Indices	172, 174
79	Exact Trig Values	341
80	Area of a Trapezium	48
81	Ordering Decimals	95
82	Factors	216
83	Fractions, Decimals, Percentages	121 to 129
84	Parts of the Circle	61
85	Multiplying Terms	18
86	Collecting Like Terms	9
87	Multiples	220
88	Substitution	20

Question	Topic	Video number
89	Speed, Distance, Time	299
90	Ratio	269, 270, 271
91	Percentage Change	233
92	Surface Area	310
93	Arc Length	58
94	Area of a Sector	46
95	Error Intervals	377
96	Best Buys	210
97	Use of a Calculator	352
98	Ratio - Problem Solving	269, 270, 271
99	Drawing Linear Graphs	186

1. From the list of numbers

3 6 8 14 16 28 41 64

(a) write down the cube numbers

..... and
(2)

(b) write down the cube root of 27.

.....
(1)

2. Mary is organising a charity hot dog sale.
 There are 18 bread rolls in each packet.
 There are 15 hot dogs in each packet.
 Mary buys exactly the same number of bread rolls as hot dogs.

What is the smallest number of each packet that Mary can buy?

..... packets of bread rolls

..... packets of hot dogs

3.

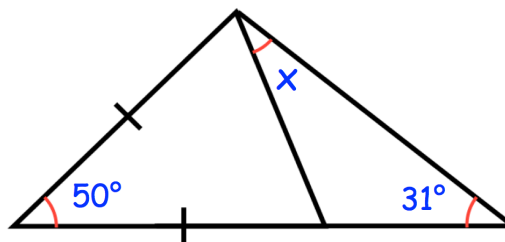

Find the size of the angle marked x.

.....⁰

(4)

4. Shown below is a parallelogram.

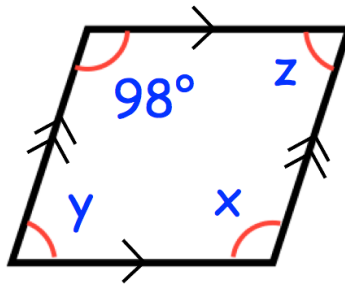

(a) Find x

.....⁰
(1)

(b) Find y

.....⁰
(1)

(c) Find z

.....⁰
(1)

5. A square is drawn inside of a regular octagon.

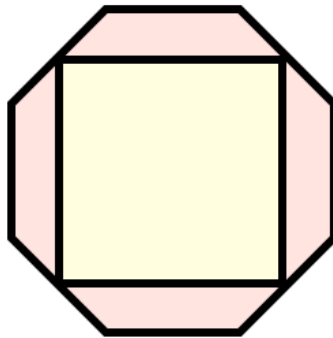

(a) Write down the order of rotational symmetry of the octagon.

.....
(1)

(b) On the diagram draw in all the lines of symmetry.

(2)

6. Below are the nets of two solid shapes.

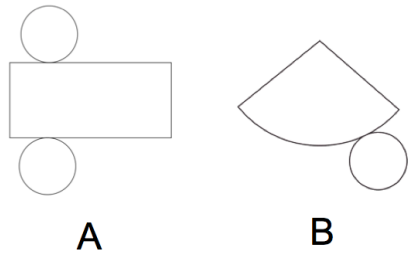

(a) Write down the shape that is made from Net A.

.....
(1)

(b) Write down the shape that is made from Net B.

.....
(1)

7. Shown below are five cards which are arranged in order from smallest to largest

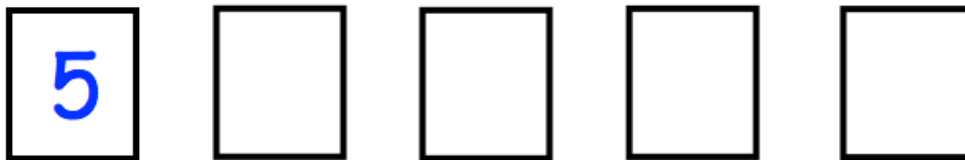

The range of the cards is 4.

The median of the cards is 8.

The mean of the cards is 7.

Work out the 4 missing numbers.

.....,, and
(4)

8Pm .

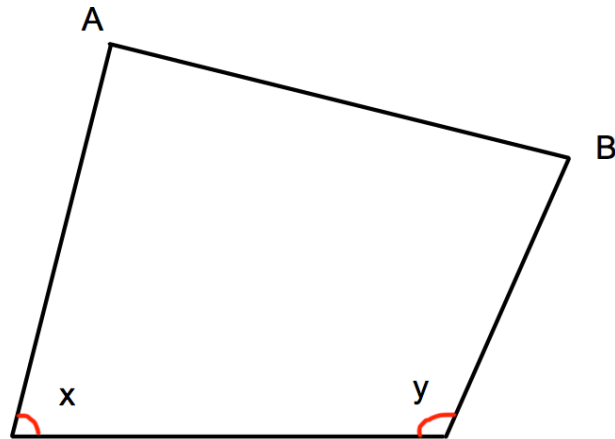

(a) Measure the length of the line AB.

.....cm
(1)

(b) What type of angle is x?

.....
(1)

(c) Measure the size of angle y.

.....^o
(1)

9. Write down all the prime numbers between 10 and 20.

.....
(2)

10. Megan says “when you square a number, the answer is always bigger.”

Show she is wrong.

.....
(2)

11. (a) Write 50 as a product of its prime factors.

.....
(2)

(b) Find the Lowest Common Multiple (LCM) of 32 and 50.

.....
(2)

12. The attendance at Frome United versus Trowbridge Rovers was 8,701.

Of this crowd, five-sevenths were male.
Calculate how many people were female.

.....
(3)

13. The table shows the time spent revising and the test scores of ten students.

Time spent revising (hours)	9	0.5	1	4	6	2	3	7	5	8
Test result (%)	90	20	38	62	68	32	46	70	60	86

The first seven points have been plotted on this scatter diagram.

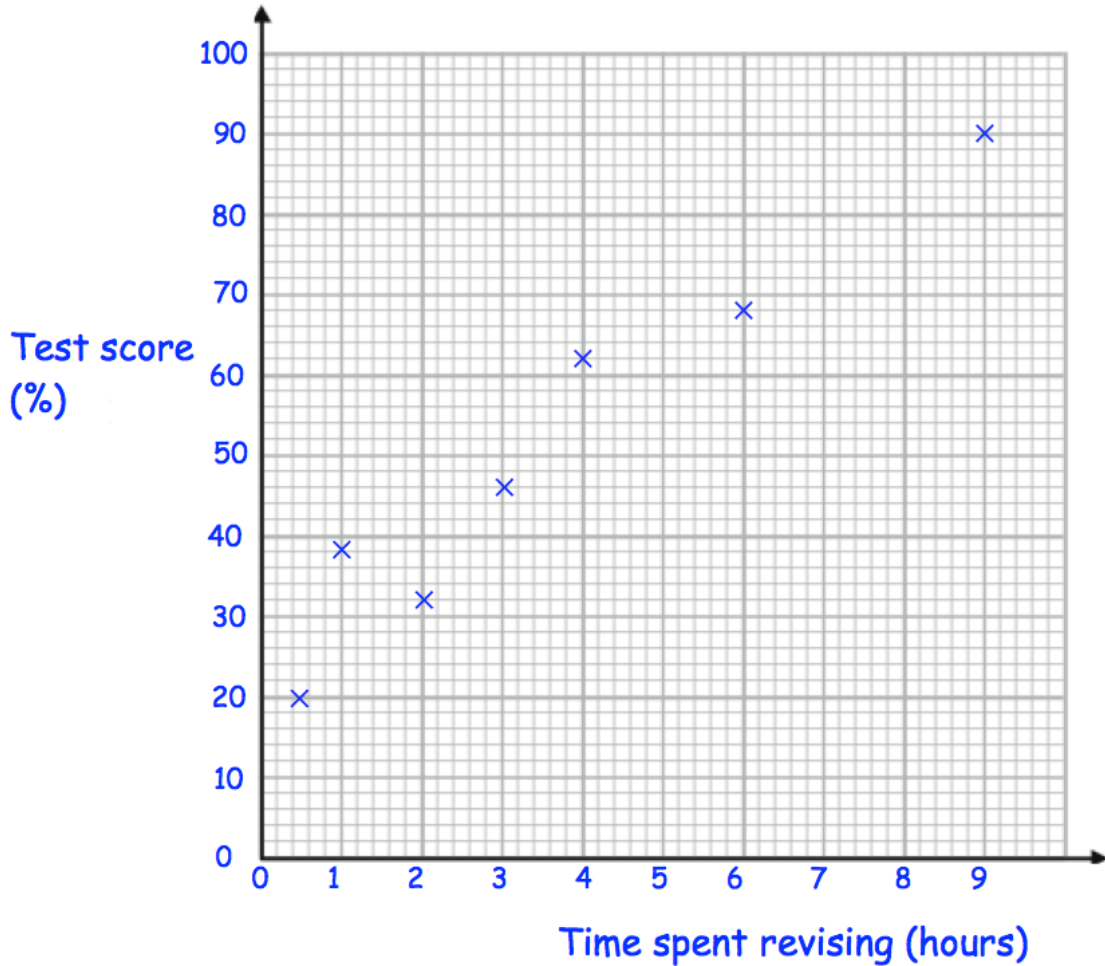

(a) Complete the scatter diagram.

(1)

(b) Describe the relationship shown in the scatter diagram.

.....

.....

(1)

(c) Draw a line of best fit on your scatter diagram.

(1)

(d) Another student has spent 4.5 hours revising.

Use your line of best fit to estimate their test result.

.....%

(1)

14. The pictogram shows the amount of money raised by students in some tutor groups at a school.

Key ○ = £10

Tutor group		Raised
S	○ ○ ○ ○ ○ ○	
T	○ ○ ○	
E		£45
P	○ ○ ○ ◐	

(a) Complete the raised column.

(2)

(b) Complete the pictogram for tutor group E.

(2)

(c) How much money was raised altogether?

£.....
(1)

15. The weight of a 2p coin is 7g.
Find the weight of £6 worth of 2p coins.
Give your answer in kilograms.

.....kilograms
(4)

16. Shown is a regular hexagon and a regular octagon.

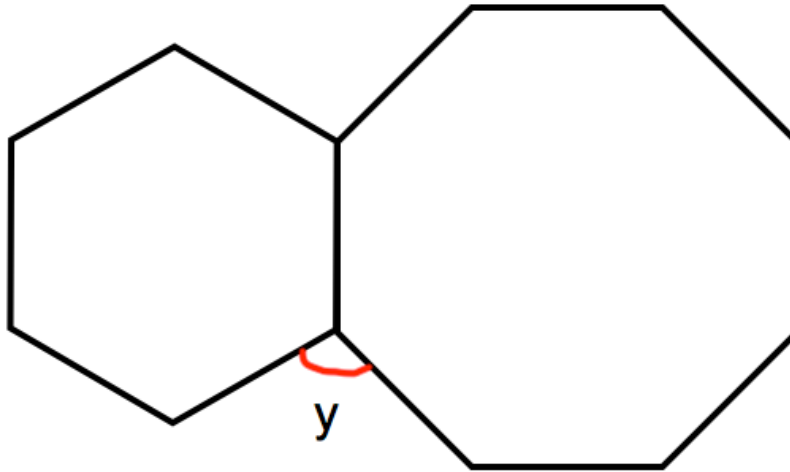

Calculate the size of angle y .

$y = \dots\dots\dots^\circ$
(3)

17.

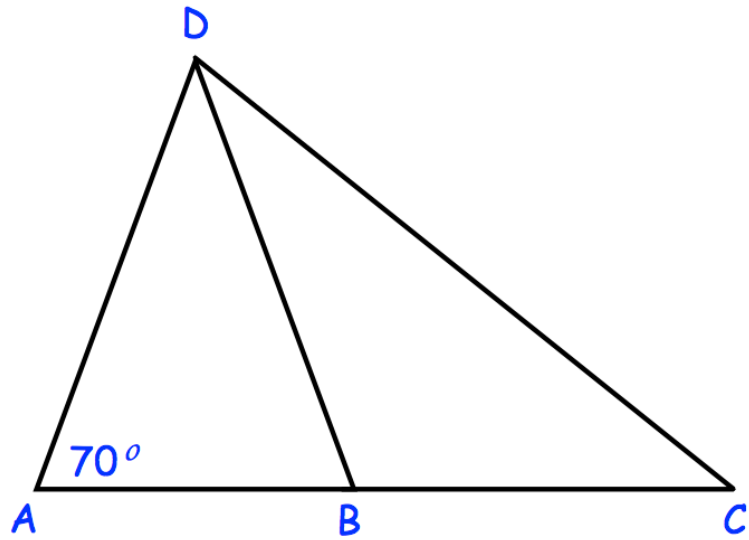

Triangles ABD and BCD are both isosceles.
AC is a straight line.

Is ADC a right angle?
Clearly explain your answer.

(4)

18. Timothy asked 30 people how long it takes them to get to school.

The table shows some information about his results.

Time (t minutes)	Frequency
$0 < t \leq 10$	2
$10 < t \leq 20$	8
$20 < t \leq 30$	12
$30 < t \leq 40$	7
$40 < t \leq 50$	1

Work out an estimate for the mean time taken.

.....minutes
(4)

20. Sophie went to Spain.
She changed £225 into euros (€).

The exchange rate was £1 = €1.62

(a) Change £225 into euros (€).

€.....
(2)

On her return to England, Sophie changed €66 into pounds (£)

The new exchange rate was £1 = €1.50

(b) Change €66 into pounds (£).

£.....
(2)

21. Lauren is given a 12% pay rise.
Her new salary is £24,080

What was Lauren's salary before the pay rise?

£.....
(3)

22. Expand and simplify $(w - 3)(w - 8)$

.....
(2)

23. Work out the n th term for this sequence

8 17 26 35 44

.....
(2)

24. Factorise

$$15y + 20$$

.....
(2)

25. Factorise $x^2 + 2x - 24$

.....
(2)

26. Solve the inequality $5x + 11 \geq 2$

.....
(2)

27.

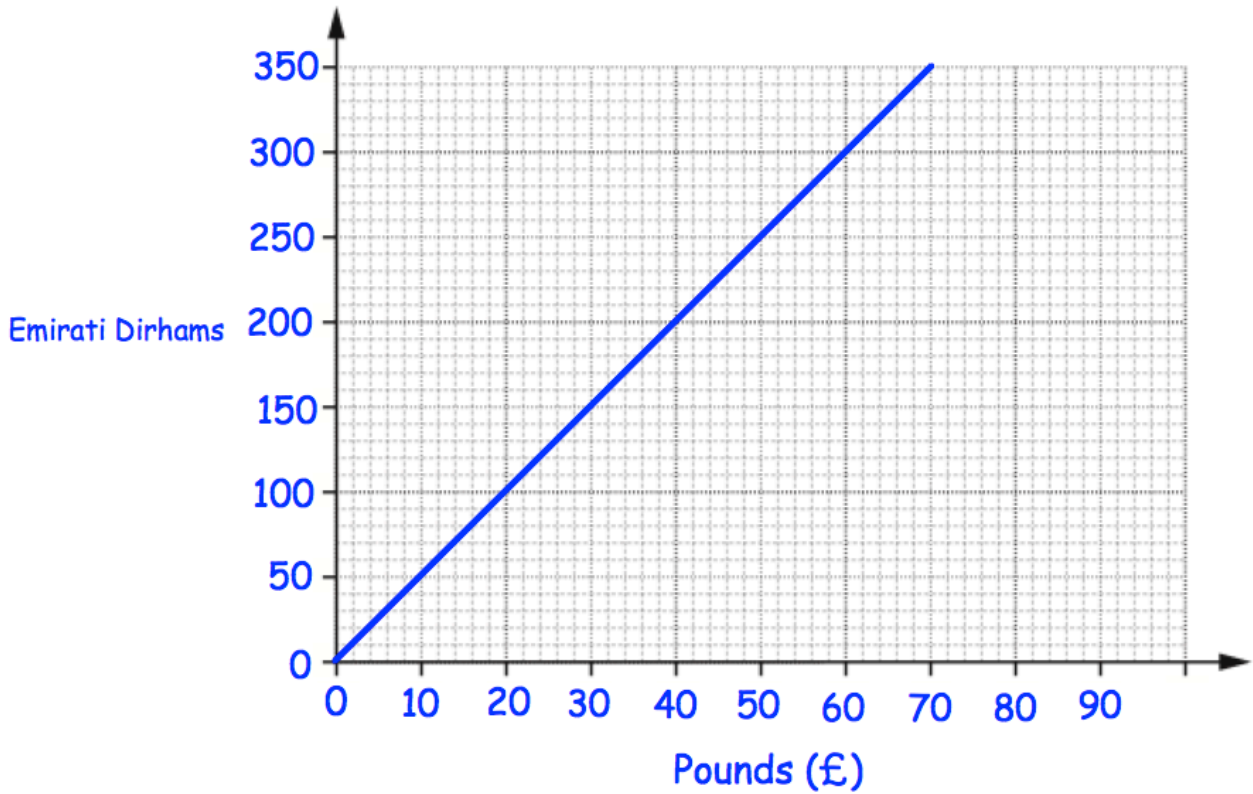

(a) Convert £50 into Dirhams.

.....Dirhams
(1)

(b) Convert 175 Dirhams into Pounds (£).

£.....
(1)

Tom wants to buy a camera.
In London the camera costs £380.
In Abu Dhabi the camera costs 2000 Dirhams.

In which city is the camera cheaper and by how much?
Give your answer in pounds.

City:..... £.....
(1)

28. Factorise $x^2 - 64$

.....
(2)

29. A radioactive substance decays over time.
Every year its mass decreases by 14%.

How many years will it take for 500kg of the substance to decay to a mass less than 200kg?

.....years
(3)

30. Mr Holland has 2500kg of rice.

- (a) Write 2500 kg in grams.
Give your answer in standard form.

.....g
(2)

- (b) One grain of rice weighs 0.03g
Write the weight of one grain of rice in standard form.

.....g
(1)

- (c) How many grains of rice are there in 2500kg of rice?
Give your answer in standard form.

.....
(2)

31. Use ruler and compasses to construct the perpendicular bisector of AB. You **must** show clearly all your construction arcs.

A .

. B

(2)

32. The diagram shows two lighthouses.

A boat is within than 8 miles of lighthouse A.

The same boat is within 6 miles of lighthouse B.

Shade the possible area in which the boat could be.



(2)

33. Shown below is a trapezoid prism.

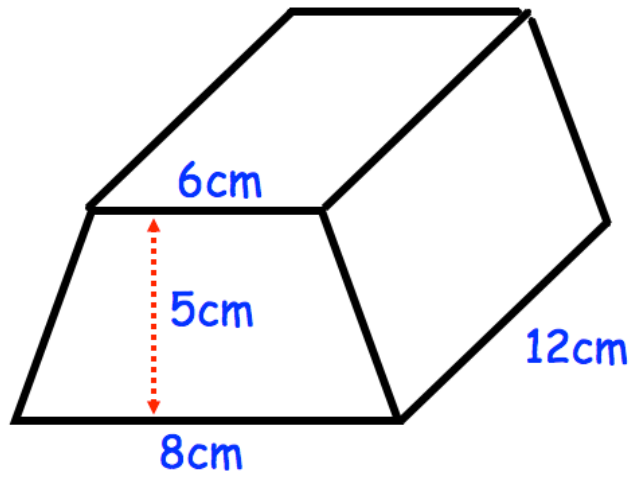

Find the volume of the prism.

.....cm³
(4)

34.

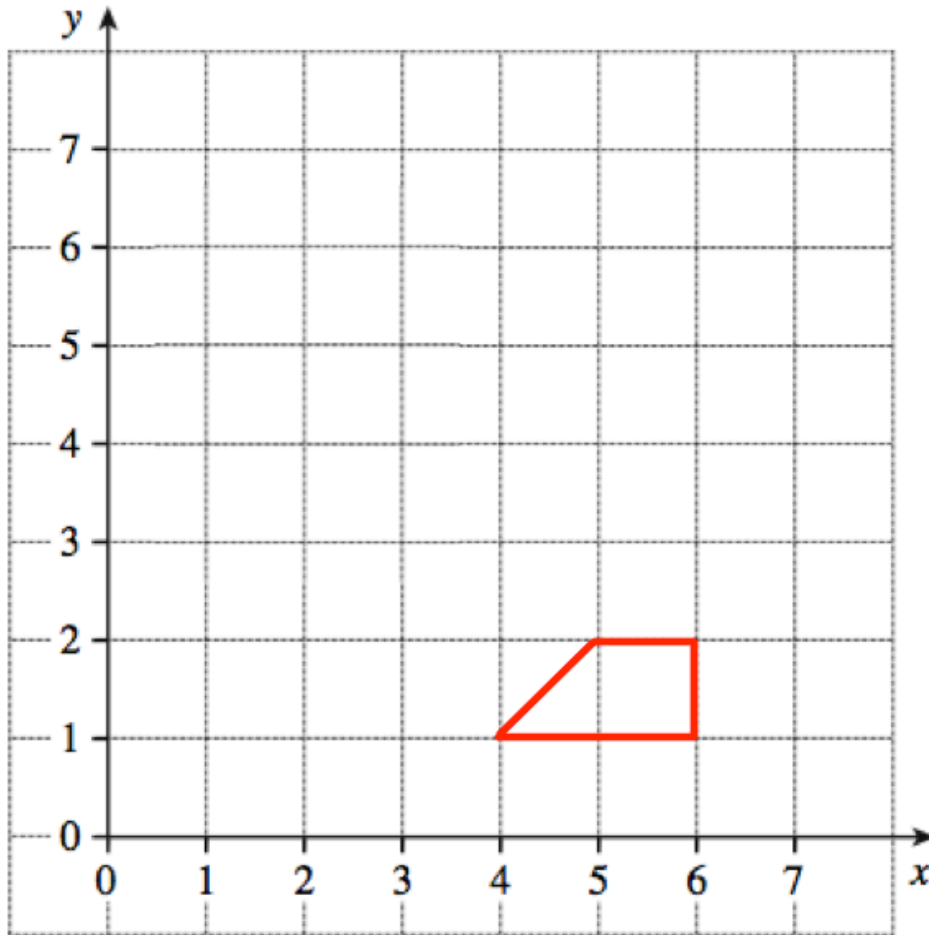

Enlarge the trapezium by scale factor 3, centre (6, 0).

(2)

35. A primary school has a running track.
It has two straights of 50 metres.
Also there are two 'bends' that are semicircles with diameter 30 metres.

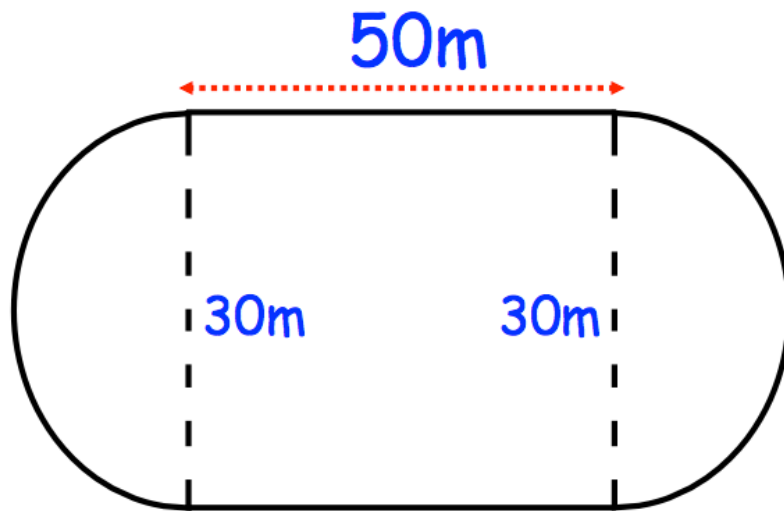

Work out the distance around the running track.

.....m
(5)

36. The diagram shows a rectangle with a circle cut out.

Not drawn to
scale

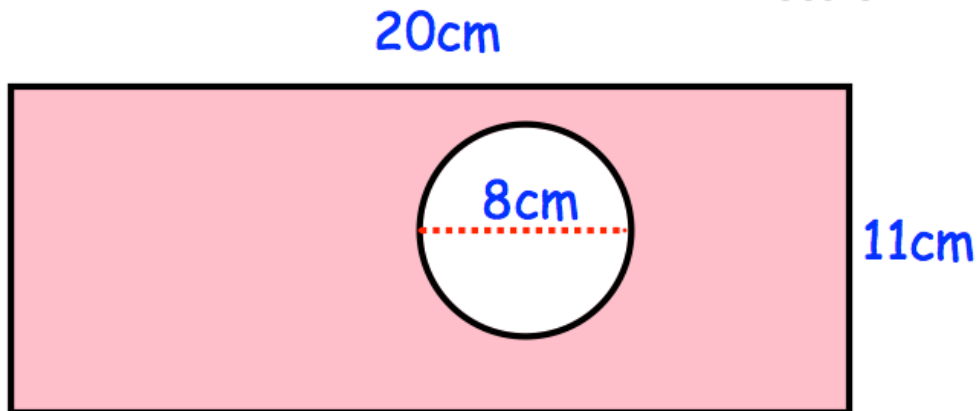

The rectangle has length 20cm and width 11cm.
The circle has diameter 8cm.

Work out the shaded area.
Give your answer correct to 2 decimal places.

.....cm²
(4)

37. Below is a cylinder with radius 2cm and height 5cm.

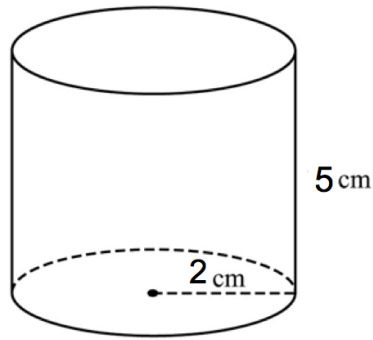

Calculate the volume of the cylinder.

.....cm³
(3)

38. Triangle ABC has a right angle.
Angle BAC is 25°
AC = 12.5cm

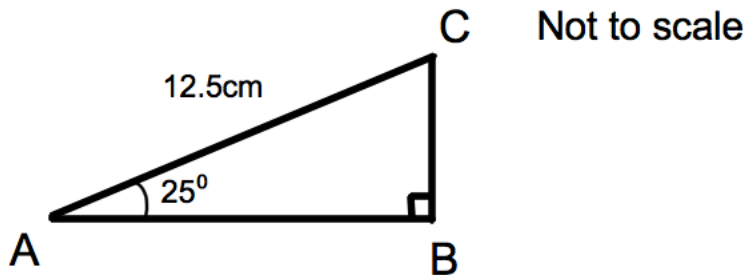

Calculate the length of AB

.....cm
(3)

39.

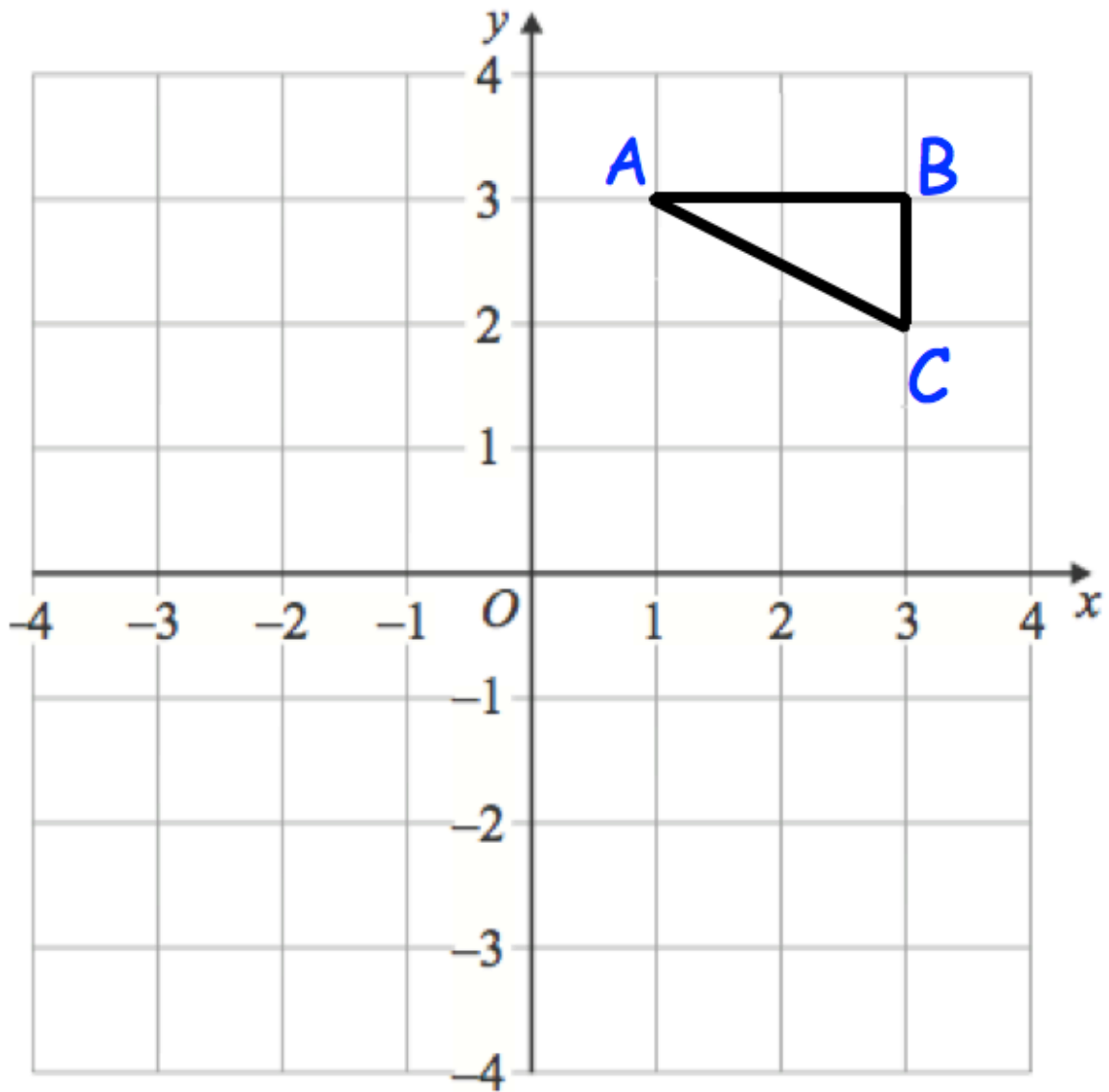

Rotate triangle ABC 90° clockwise about centre (0, 0)

(3)

40.

Not drawn accurately

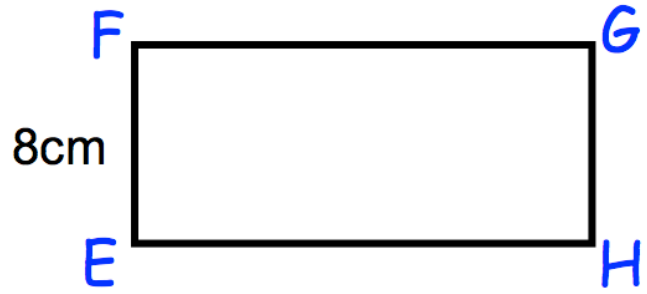
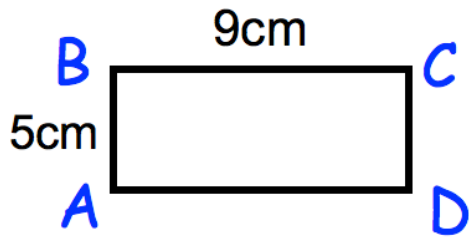

Rectangles $ABCD$ and $EFGH$ are similar.

$$AB = 5\text{cm}$$

$$BC = 9\text{cm}$$

$$EF = 8\text{cm}$$

Work out the length of FG .

.....cm
(2)

41. Solve the simultaneous equations

$$2x + 4y = 26$$

$$3x - y = 4$$

Do not use trial and improvement

$$x = \dots\dots\dots y = \dots\dots\dots$$

(3)

42. Make w the subject of the formula

$$y = 3w - a$$

$$w = \dots\dots\dots$$

(2)

43.

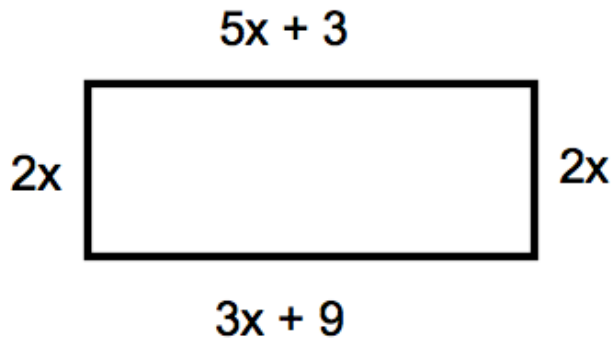

The diagram shows a rectangle. The sides are measured in centimetres.

(a) Explain why $5x + 3 = 3x + 9$

.....
.....

(1)

(b) Solve $5x + 3 = 3x + 9$

$x = \dots\dots\dots$ cm

(2)

(c) Calculate the perimeter of the rectangle.

$\dots\dots\dots$ cm

(2)

44. The table gives information about students staying after school to play sport.

Sport	Frequency
Netball	15
Hockey	10
Rugby	26
Football	9

Draw an accurate pie chart to show this information.

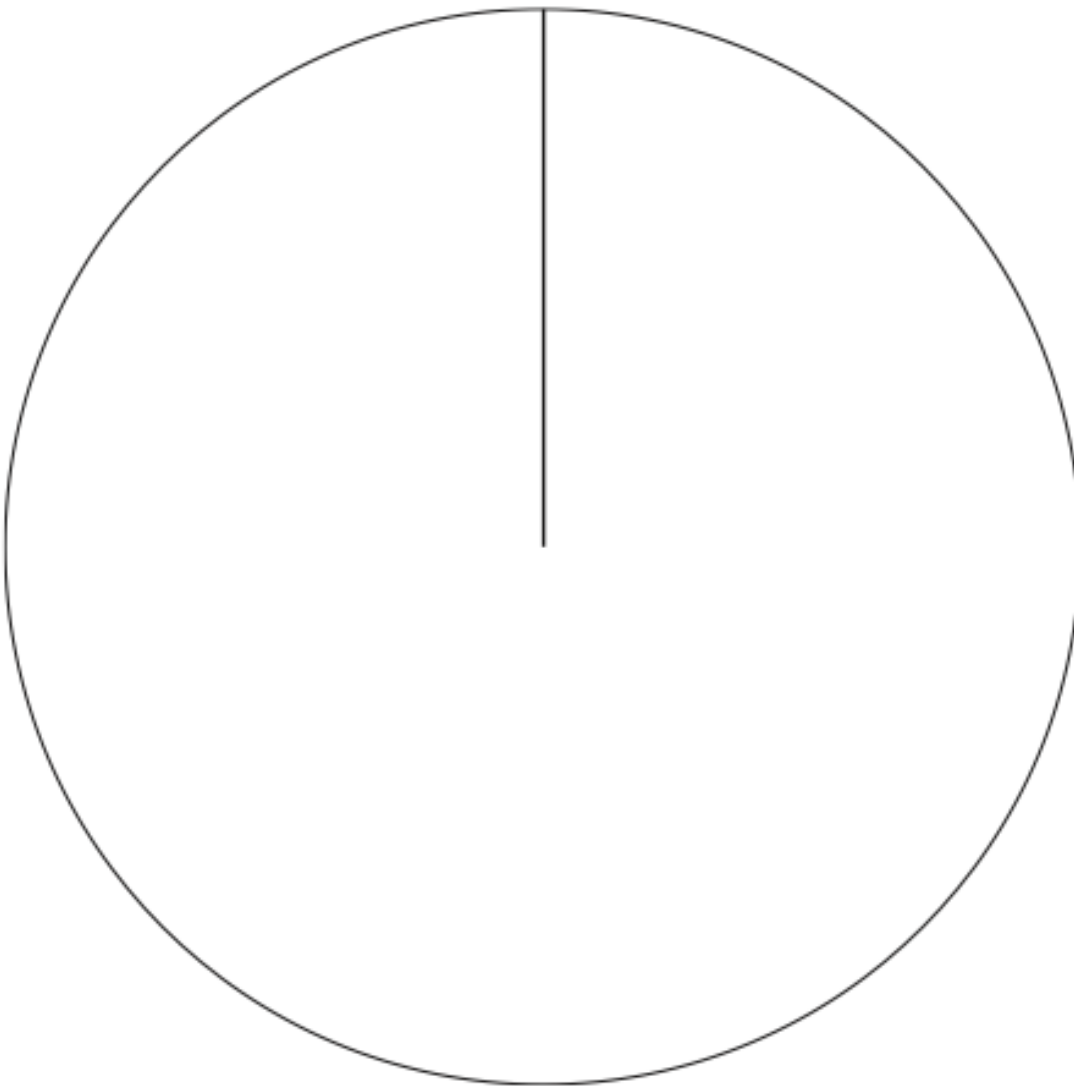

45.

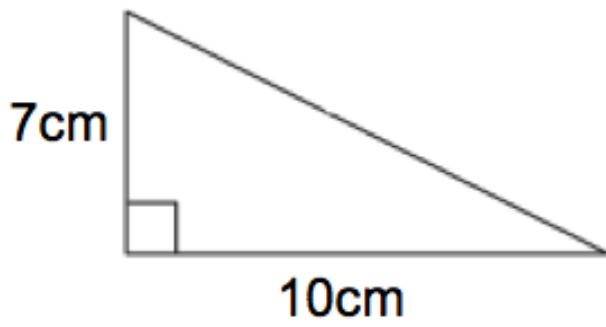

Shown is a right-angled triangle.

Work out the perimeter of the triangle

..... cm
(4)

46. A mobile phone mast has a range of 3km.



Calculate the area of the shaded region.
Give your answer to 2 decimal places.

.....km²
(2)

47. This is a map of an island.

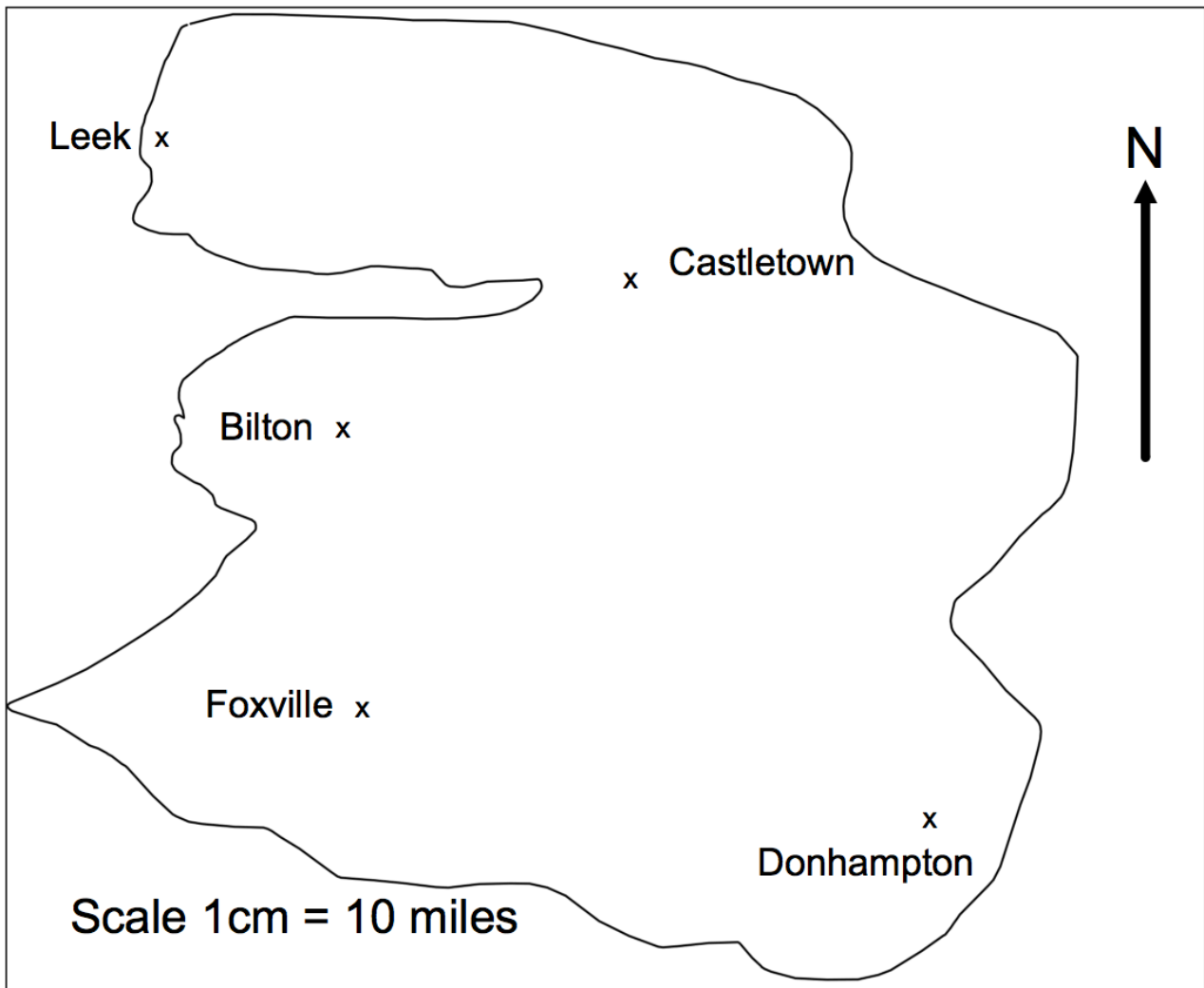

A helicopter flies in a straight line from Leek to Donhampton.

(a) How far does the helicopter fly?

.....miles
(2)

(b) Write down the bearing of Donhampton from Leek.

.....°
(1)

48. Here are four digits.

9 4 7 5

(a) Use two of these digits to make the largest possible two-digit number.

.....
(1)

(b) Use all four of these digits to make the four-digit number closest to 5000.

.....
(1)

49. (a) Work out the difference between -3°C and 4°C

..... $^{\circ}\text{C}$
(1)

At 5am the temperature is -6°C

By 2pm the temperature went up by 9°C

From 2pm to 11pm the temperature went down by 15°C

(b) Work out the temperature at 11pm

..... $^{\circ}\text{C}$
(2)

50.

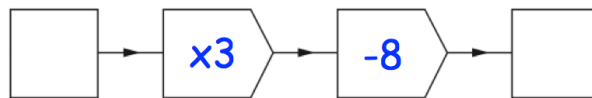

(a) Work out the output, when the input is 10.

.....
(1)

(b) Work out the input, when the output is 13.

.....
(1)

(c) If the input is the same as the output, work out the input.

.....
(1)

51. The points A (0, 3), C (2, -3) and D (-2, -2) are shown.

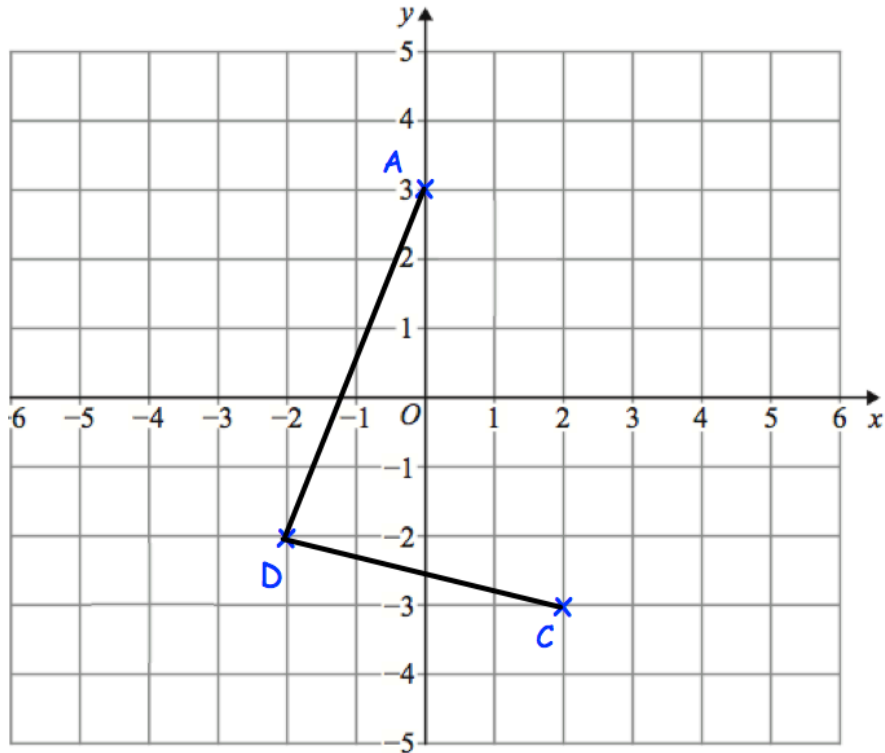

ABCD is a parallelogram.

Complete the parallelogram and write down the coordinates of B.

(.....,)
(2)

52. An airplane has economy and first class seating.
There are s seats in each row in economy.
There are t seats in each row in first class.
There are 8 rows in first class and 18 rows in economy.

Write down an expression, in terms of s and t , for the number of seats on the airplane.

.....
(2)

53. Below is a solid.

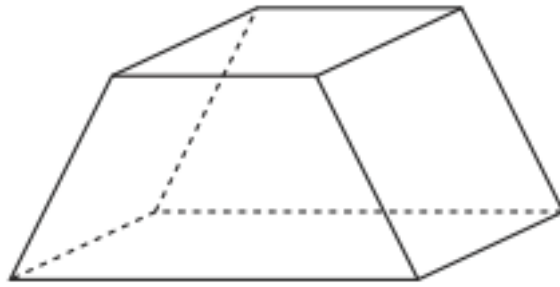

(a) Write down the number of faces

.....
(1)

(b) Write down the number of vertices

.....
(1)

54. Here is part of a timetable for a bus.

Southville	09 18	10 38	12 05
Leek	09 28	10 48	-----
Milton	09 41	11 01	-----
Newtown	09 49	11 09	-----
Red Island	09 55	11 15	12 36
Sandville	10 13	11 33	-----
Bakerstown	10 31	11 51	13 00

A bus leaves Southville at 10 38

(a) At what time should the bus arrive at Newtown?

.....
(1)

(b) How long will the journey take?

.....minutes
(1)

James arrives at the Milton bus stop at 09 29.
He waits for the next bus to Red Island.

(c) (i) How many minutes should he wait?

.....minutes
(1)

(ii) At what time should James arrive at Red Island?

.....
(1)

Sally wants to travel from Southville to Bakerstown.
The 12 05 is an 'express' bus.

(d) How many minutes shorter is the journey if she takes the 'express bus'?

.....minutes
(2)

55.

Bilton				
23	Newtown			
28	30	Portsville		
23	11	32	Leek	
55	42	67	14	Castletown

The table above shows the distance in miles between some cities.

(a) Write down the distance between Bilton and Leek.

..... miles
(1)

James drives from Newtown to Castletown.
He then drives from Castletown to Bilton.
He then drives from Bilton to Leek.

(b) Work out the total distance travelled.

..... miles
(2)

56. Below is a line graph that shows the population of a village.

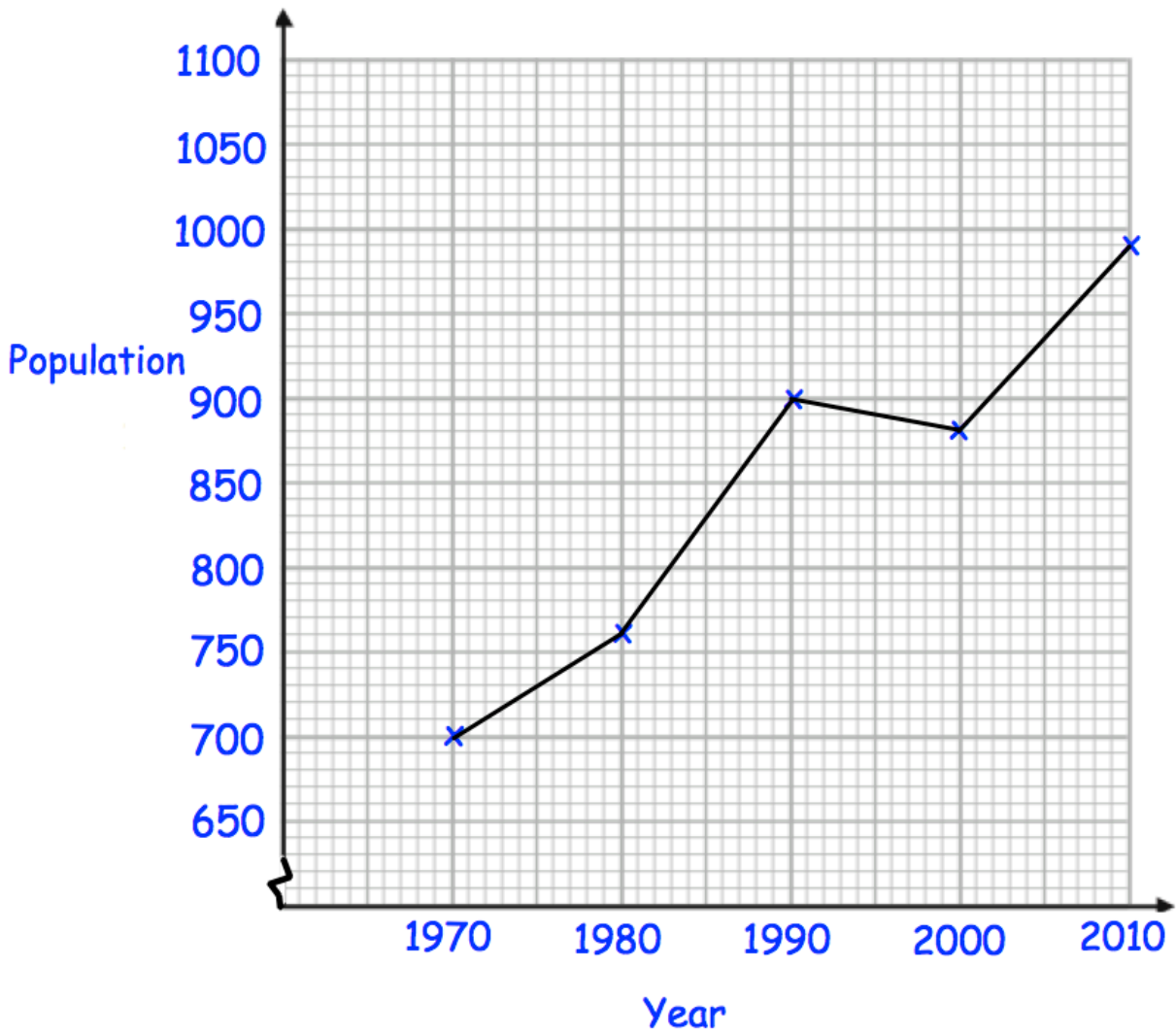

(a) What was the population in 1980?

.....
(1)

(b) In which year was the population 700?

.....
(1)

The population is expected to increase by 120 by 2020.

(c) Work out the expected population in 2020.

.....
(2)

57. The table shows the distance travelled to school by 50 students.

Distance (miles)	Frequency
$0 < d \leq 2$	20
$2 < d \leq 4$	12
$4 < d \leq 6$	11
$6 < d \leq 8$	4
$8 < d \leq 10$	3

(a) Draw a frequency polygon to represent this data.

(2)

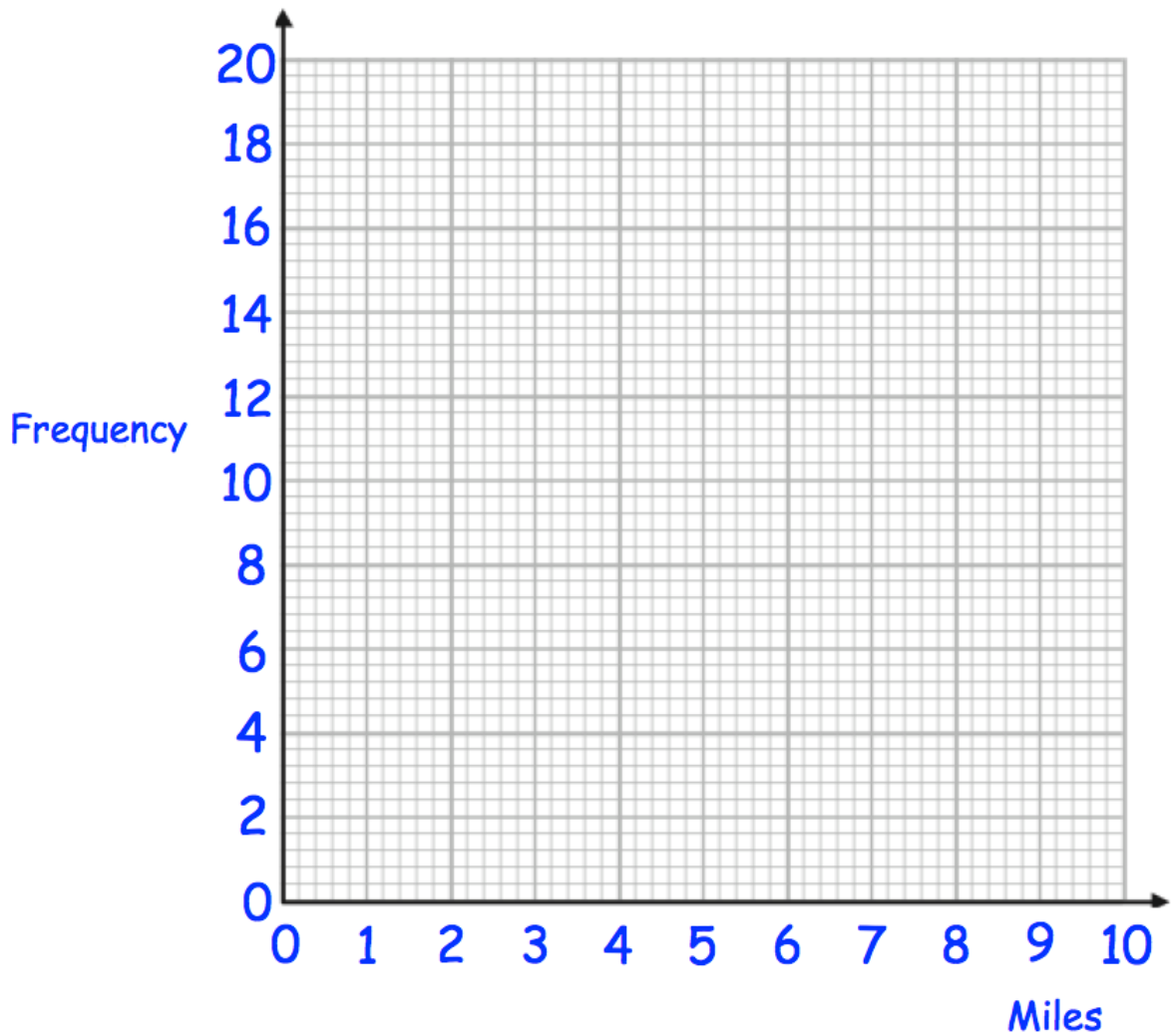

One student is chosen at random.

(b) Work out the probability that this student travels more than 6 miles to school.

.....
(1)

58. William is going to attend a two day summer camp at his local leisure centre. He can take part in one activity on Monday and one activity on Tuesday.

Monday	Tuesday
Golf	Ice-skating
Football	Swimming
Rugby	Dodgeball
Hockey	Basketball

List all the possible combinations of activity he can take part in.

.....

.....

.....

.....

.....

.....

59. The number of passengers on 10 buses was recorded. The stem and leaf diagram shows this information.

Key: 1|4 means 14 passengers

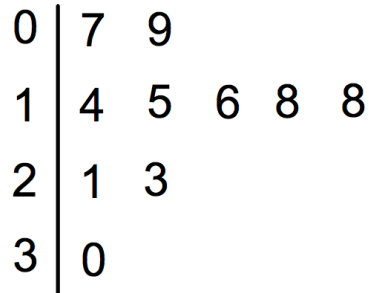

- (a) Work out the median.

.....
(1)

A bus is selected at random.

- (b) What is the probability the bus has more than 20 passengers?

.....
(1)

The next bus has 32 passengers.

- (c) Tick the box to show how this will effect the range.

The range will
decrease

The range will
stay the same

The range will
increase

(1)

60.



Holly works out the answer to $135.66 + 193.88$ on a calculator.

Her answer is shown on the calculator.

(a) Round her answer to the nearest 10.

.....
(1)

(b) Round her answer to the nearest 100.

.....
(1)

(c) Round her answer to the nearest integer.

.....
(1)

(d) Round her answer to one decimal place.

.....
(1)

61. Joanne sees this special offer in a shop.

Special Offer	
iPod	£189
Headphones	£25
Buy both items and receive a 4% discount	

Joanne buys both items.

How much does she pay?

£.....
(3)

62. The angles in a triangle are in the ratio 1 : 2 : 9

What is the size of the largest angle?

.....
(2)

63. 62 people took part in a talent show
 39 of the people were women.
 11 people made it through to the final and the rest were eliminated.
 5 men made it through to the final

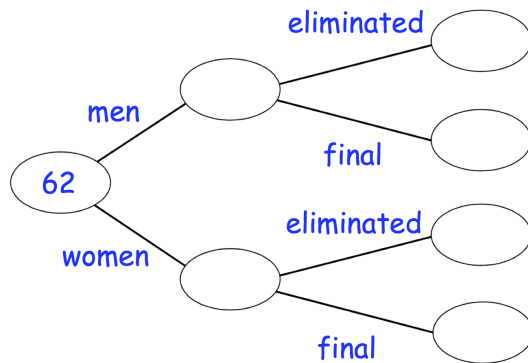

a) Complete the frequency tree

(2)

b) What fraction of the men made it through to the final?

.....
 (2)

64. Shown below is a right-angled triangle.

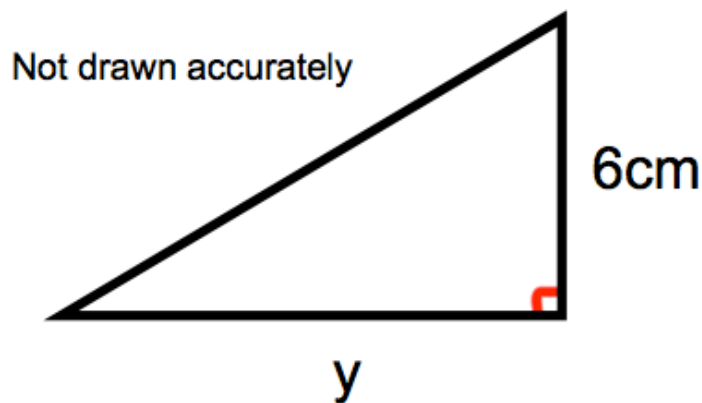

The area of the triangle is 21cm^2
 Calculate y , the length of the base.

.....cm
 (2)

65. $\xi = \{1, 2, 3, 4, 5, 6, 7, 8, 9, 10, 11, 12, 13, 14, 15, 16\}$

A = multiples of 3

B = multiples of 5

(a) Complete the Venn diagram

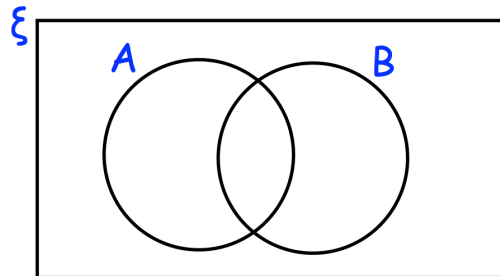

(3)

One of the numbers is selected at random.

(b) Write down $P(A \cap B)$

.....
(1)

66. Chris and Molly win money in a competition.
They share the money in the ratio 2 : 3
Molly receives £240.

(a) How much money does Chris receive?

£.....
(2)

(b) How much money did they win in the competition?

£.....
(1)

67. Work out

$$10^{-2}$$

Give your answer as a decimal.

.....
(2)

68. Solve $4y + 1 = 6y + 26$

$y = \dots\dots\dots$
(2)

69. A straight line L is shown on the grid.

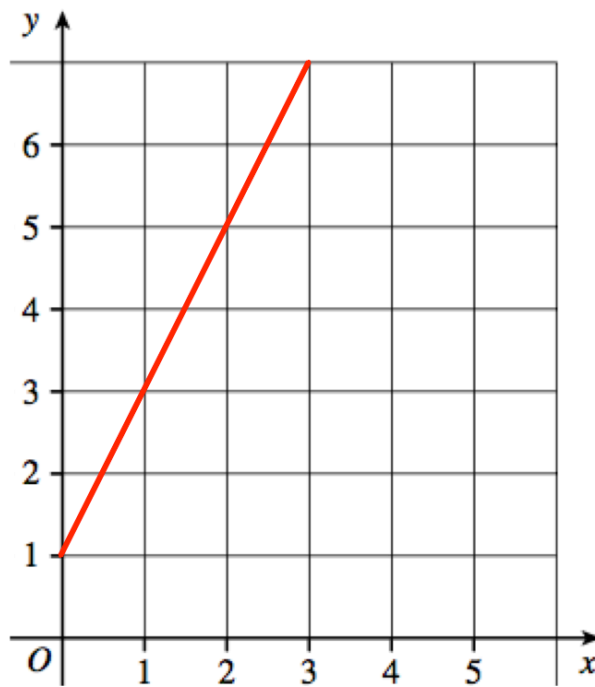

Work out the equation of line L

$\dots\dots\dots$
(3)

70. (a) Complete the table of values for $y = x^3 - 2x + 3$

x	-2	-1	0	1	2
y					

(2)

(b) On the grid, draw the graph of $y = x^3 - 2x + 3$ for the values of x $-2 \leq x \leq 2$

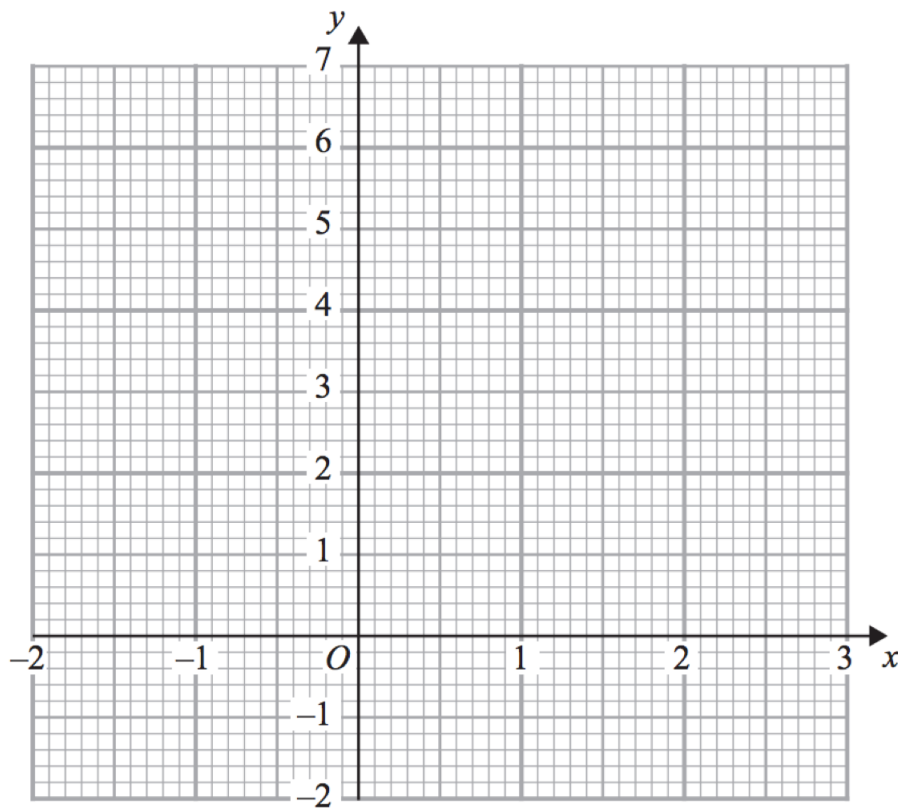

(2)

71. (a) Complete the table of value for $y = \frac{4}{x}$

x	0.5	1	2	4	8	10
y						

(2)

(b) On the grid, draw the graph of $y = \frac{4}{x}$ for $0.25 \leq x \leq 10$

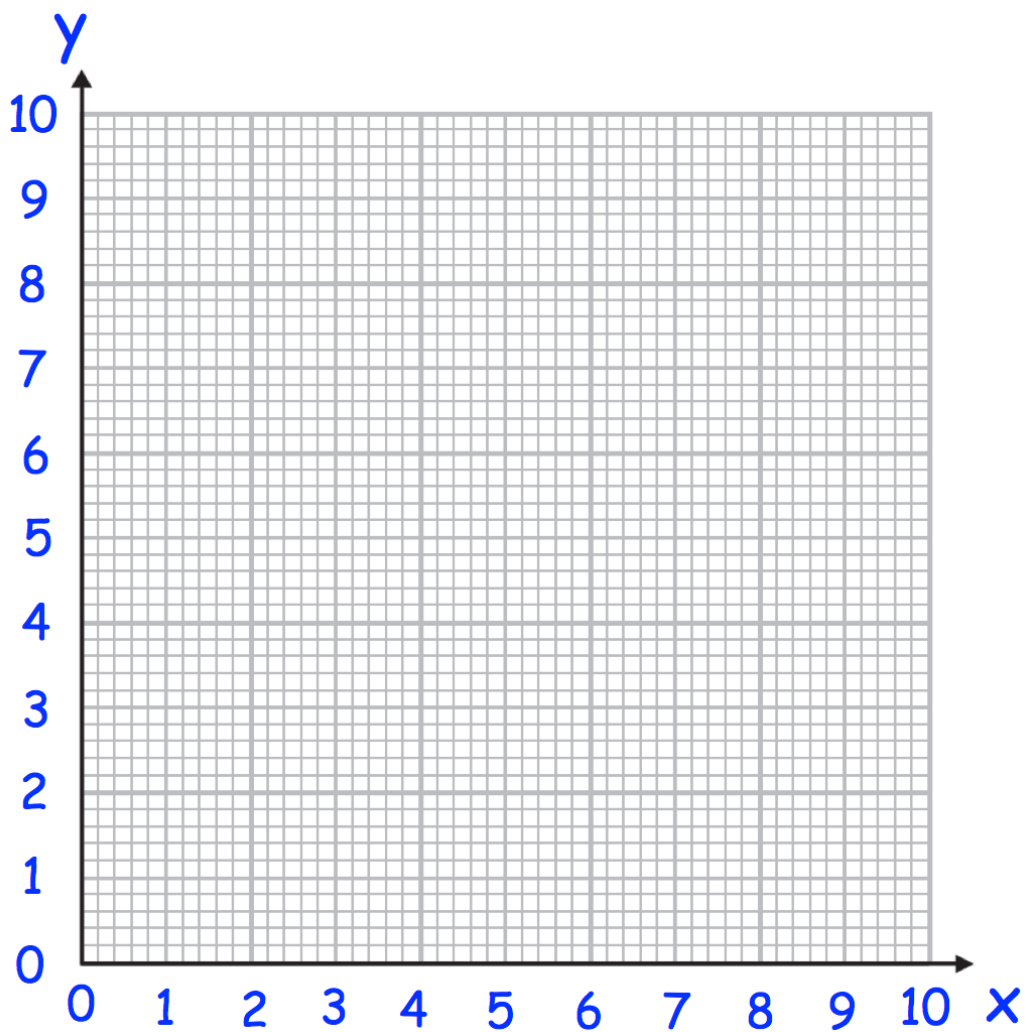

(2)

72. Iron has a density of 7.8g/cm^3 .
A solid iron statue has a mass of 877.5g .
Work out the volume of the statue.

..... cm^3
(2)

73.

A box is placed on the floor.

The area of the box in contact with the floor is 2.4m^2
Pressure exerted on the floor 16 newtons/m^2

Work out the force exerted by the box on the floor.

..... N
(3)

74. A cone has base radius 5cm and perpendicular height 9cm.

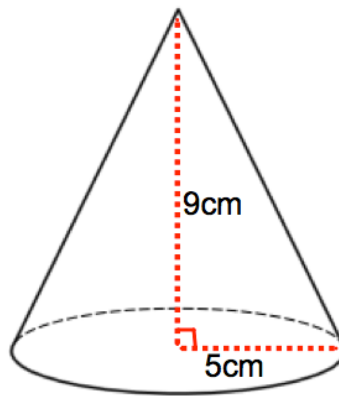

Volume of cone $= \frac{1}{3} \pi r^2 h$

Curved surface area of cone $= \pi r l$

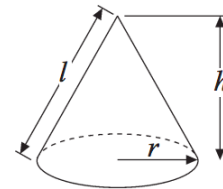

Work out the volume of the cone.

.....cm³
(3)

75. Given $\mathbf{a} = \begin{pmatrix} 6 \\ -4 \end{pmatrix}$ $\mathbf{b} = \begin{pmatrix} -2 \\ 1 \end{pmatrix}$

Work out $3\mathbf{a} - \mathbf{b}$

.....
(3)

76. Shown below are six triangles that are not drawn accurately.

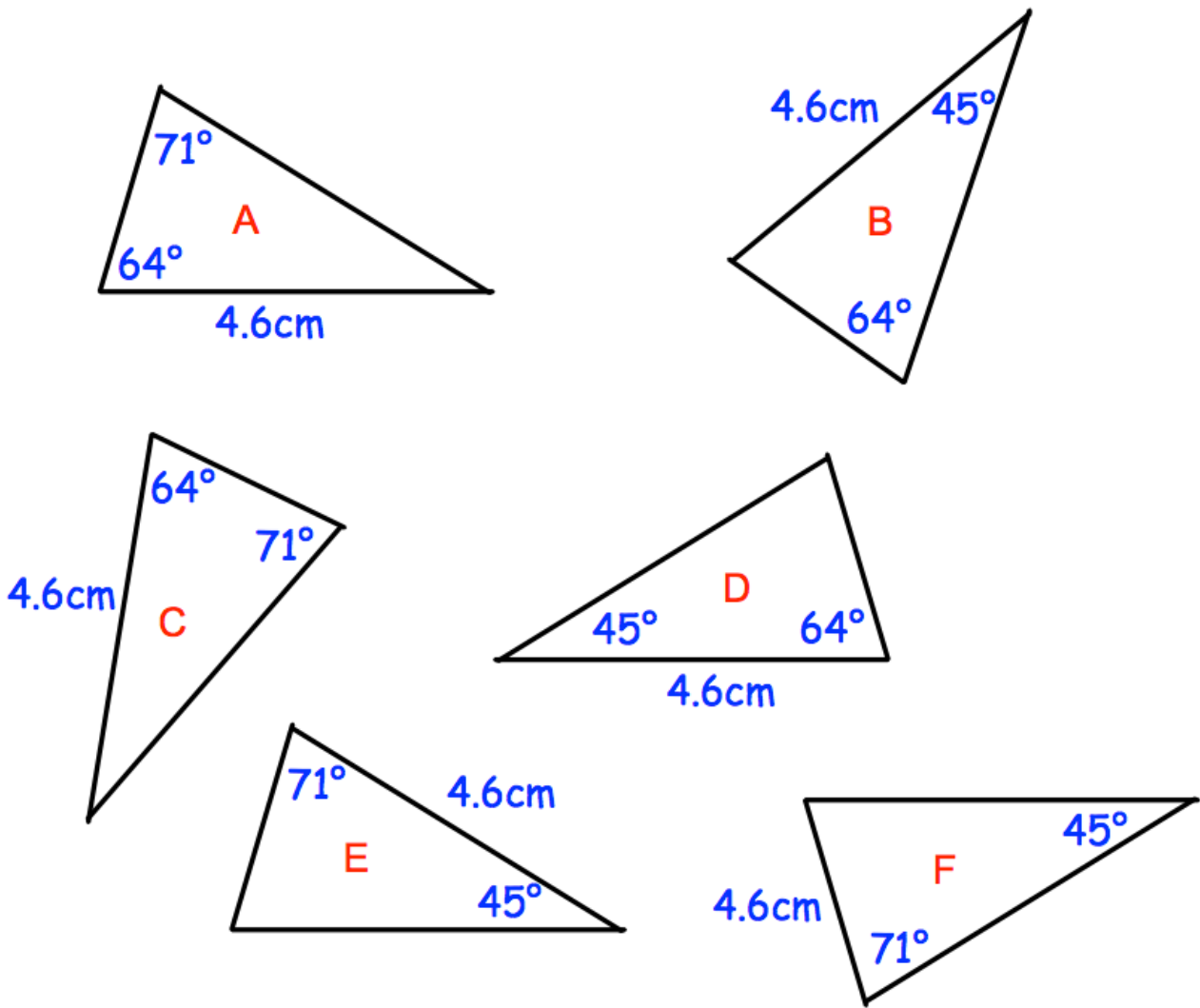

Which two triangles are congruent to triangle A?

..... and

(2)

77.

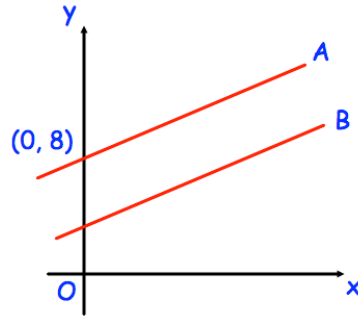

The lines A and B are parallel.

The line A passes through the point (0, 8)

The line B has equation $y = 3x + 4$

Write down the equation of line A

.....
(2)

78.

(a) Simplify

$$m^9 \times m^2$$

.....
(1)

(b) Simplify

$$\frac{m^{10}}{m^2}$$

.....
(1)

(c) Simplify

$$(m^3)^6$$

.....
(1)

79. Write down the exact value of $\sin 30^\circ$

.....
(1)

80.

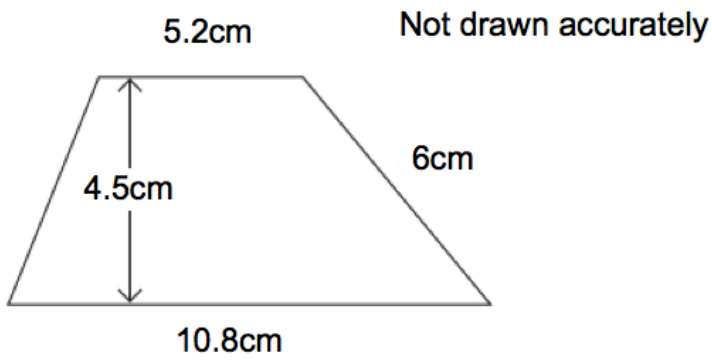

Calculate the area of the trapezium.

.....cm²
(2)

81.

Write these numbers in order of size.
Start with the smallest number.

0.92 0.901 0.99 0.099 0.909

.....
(1)

82. Write down all the factors of 36.

.....
(2)







83. Complete the table.

Fraction	Decimal	Percentage
		85%
	0.12	
$\frac{23}{25}$		

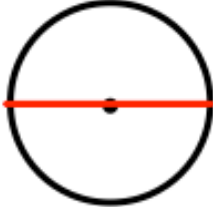
(4)

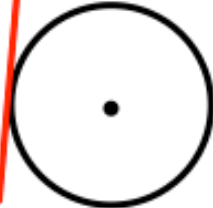
84. Here are 6 diagrams and 6 labels.
In the diagram the centre of the circle is shown with a dot.

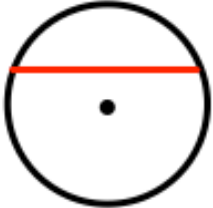
Match each diagram to its label.
One has been done for you.

Label	Diagram
Circle and radius	
Circle and segment	
Circle and arc	
Circle and diameter	
Circle and tangent	
Circle and chord	

85.

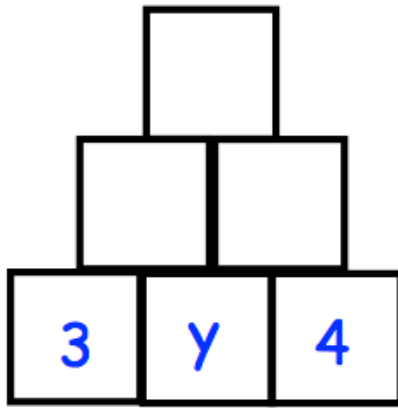

To find the contents of each empty box, multiply the two terms directly beneath it.

Complete the multiplication pyramid.

(3)

86.

Simplify $9h + 5k + 4h - 8k$

.....
(2)

87 (a) Write down two multiples of 7.

..... and
(1)

(b) Write down two multiples of 9.

..... and
(1)

(c) Write down a number which is a multiple of both 7 and 9.

.....
(1)

88.

$$y = w - 2a^2$$

$$w = 400$$

$$a = 5$$

Work out the value of y .

.....
(2)

89.

The distance from Leek to Milton is 310 miles.

A train travels this distance in 4 hours 15 minutes.

Calculate the average speed of the train.

.....mph
(3)

90. Two numbers are in the ratio 3:7
One of the numbers is 42
There are two possible values for the other number.
What are the two possible values?
-

91. Sarah bought a TV for £250
Three years later she sold it for £180

Work out her percentage loss

.....%
(3)

- 92.

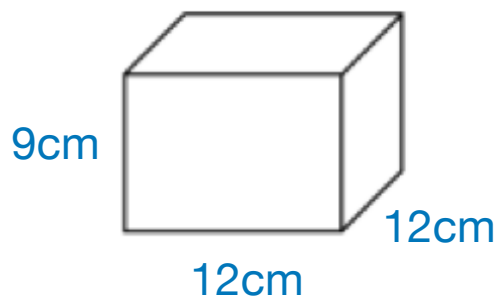

Work out the surface area of this cuboid.
State the units of your answer.

.....
(3)

93.

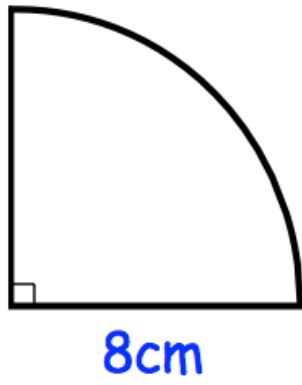

Calculate the perimeter of the sector.

.....cm
(2)

94.

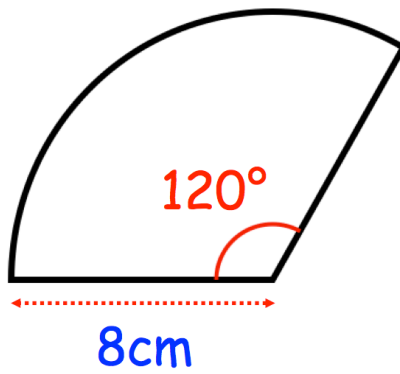

Calculate the area of the sector.

.....cm²
(2)

95.

A number, n , is rounded to 1 decimal place.

The result is 1.3

Using inequalities, write down the error interval for n .

.....
(2)

96.

A supermarket sells Baked Beans in two different size cans.



215g

40p



395g

74p

Which size can is the best value for money?
You must show all your working.

(4)

97.

Work out

$$\sqrt[4]{100 - 2.4^3}$$

Write down all the figures from your calculator display.

.....
(2)

98.

The sizes of the interior angles of a triangle are in the ratio 1:3:8
Calculate the difference in size between the largest and smallest angles.

.....
(4)

99. On the grid, draw $x + 2y = 6$ for values of x from -2 to 2 .

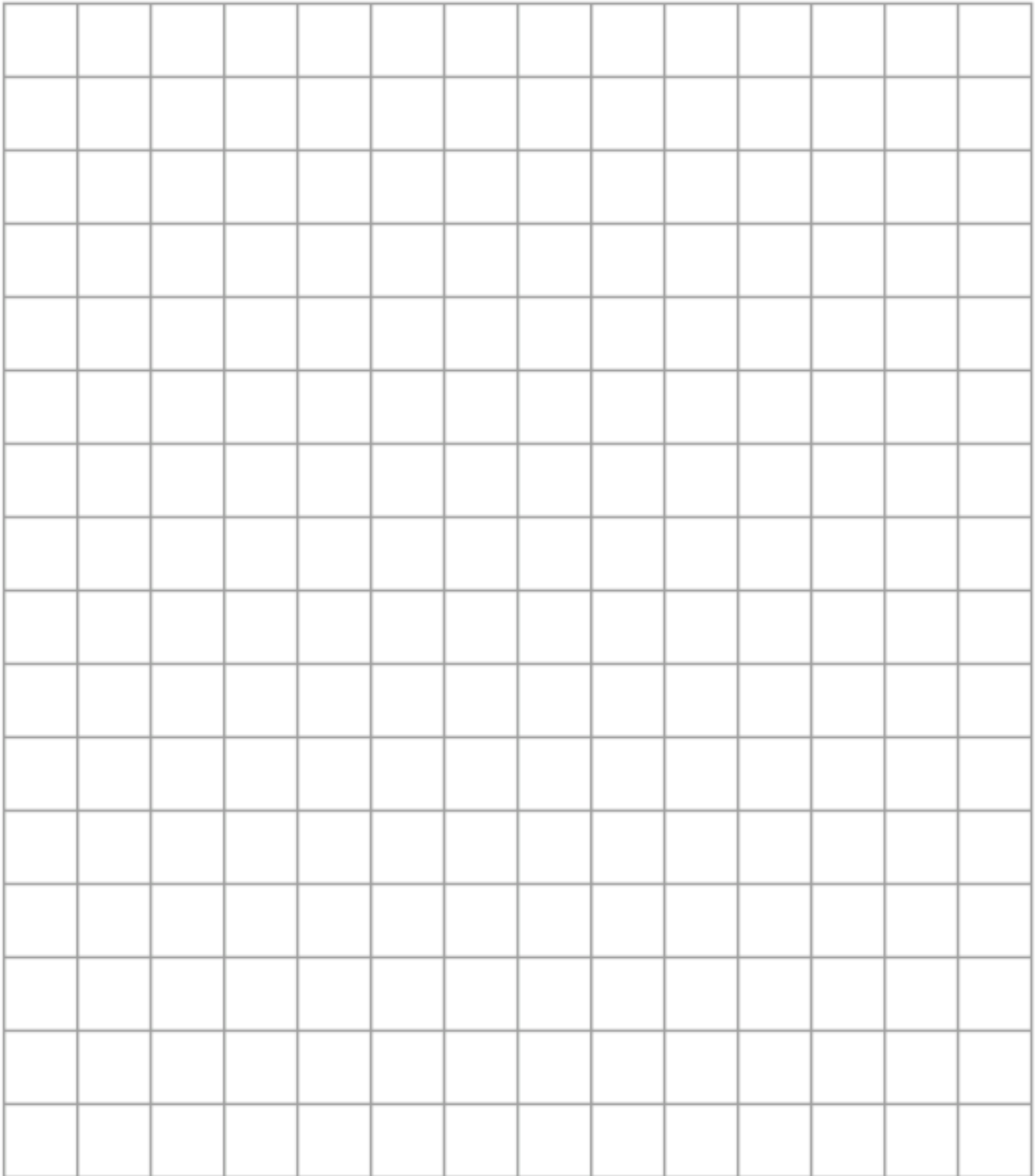

(4)