

# AS AND A-LEVEL **BIOLOGY**

AS (7401)  
A-level (7402)

Required practical handbook

Version 2.0



---

This is the **Biology** version of this practical handbook.

**The sections on tabulating data, significant figures, uncertainties, graphing, biological drawings, statistical tests in Biology, and subject specific vocabulary are particularly useful for students and could be printed as a student booklet by schools.**

The information in this document is correct, to the best of our knowledge as of October 2017.

### Key

There have been a number of changes to how practical work will be assessed in the new A-levels. Some of these have been AQA-specific, but many are by common agreement between all the exam boards and Ofqual.

The symbol  signifies that **all boards** have agreed to this.

The symbol  is used where the information relates to **AQA only**.

---

## Contents

Introduction .....	4
Practical work in reformed A-level Biology, Chemistry and Physics .....	7
Practical skills assessment in question papers .....	12
Guidelines for supporting students in practical work .....	18
Use of lab books.....	20
Cross-board statement on CPAC .....	22
Criteria for the assessment of practical competency.....	23
Extra information on the endorsement.....	25
Monitoring visits.....	28
Evidence for the endorsement.....	32
Cross-board apparatus and techniques and AQA required activities .....	34
Tabulating data.....	37
Significant figures .....	38
Uncertainties .....	39
Graphing .....	45
Biological drawing .....	54
Statistical tests in Biology .....	56
Subject specific vocabulary .....	63
Practical ladders and example experiments .....	66
Appendix: questions from teachers.....	166

---

## Introduction

---

Practical work brings science to life, helping students make sense of the universe around them. That's why we've put practical work at the heart of our Biology, Chemistry and Physics A-levels. Practical science allows scientific theory to transform into deep knowledge and understanding – scientific thinking. Through investigation, students uncover the important links between their personal observations and scientific ideas.

“In the best schools visited, teachers ensured that pupils understood the ‘big ideas’ of science. They made sure that pupils mastered the investigative and practical skills that underpin the development of scientific knowledge and could discover for themselves the relevance and usefulness of those ideas.”

Ofsted report

[Maintaining Curiosity. A survey into science education in schools.](#)

November 2013, No. 130135

### The purpose of this practical handbook

This handbook has been developed to support you in advancing your students to fluency in science.

Over the years, there have been many rules developed for practical work in Biology, Chemistry and Physics. Some have been prescriptive, some have been intended as guidance. Although we have always attempted to be consistent within subjects, differences have emerged over time. For example, students taking Biology may also be taking Physics and find themselves confronted with contradictory rules and guidance.

This practical handbook is an attempt to harmonise the rules and guidance for Biology, Chemistry and Physics. There are occasions where these will necessarily be different, but we will try to explain why on the occasions where that happens.

The A-level specifications accredited for first teaching in September 2015 bring with them a complete change in the way practical work is assessed.

We have worked with teachers, technicians and examiners to produce this handbook. Unless specified, all guidance is common to Biology, Chemistry and Physics at both AS and A-level and subject-specific examples are for illustration only. However, the extent to which a particular aspect is assessed will differ. Teachers should refer to the specifications and specimen materials on [aqa.org.uk/science](http://aqa.org.uk/science) for more information.

---

## The purpose of practical work

There are three interconnected, but separate, reasons for doing practical work in schools and colleges. They are:

1. To support and consolidate **scientific concepts** (knowledge and understanding).

This is done by applying and developing what is known and understood of abstract ideas and models. Through practical work we are able to make sense of new information and observations, and provide insights into the development of scientific thinking.

2. To develop **investigative skills**. These transferable skills include:

- devising and investigating testable questions
- identifying and controlling variables
- analysing, interpreting and evaluating data.

3. To build and master **practical skills** such as:

- using specialist equipment to take measurements
- handling and manipulating equipment with confidence and fluency
- recognising hazards and planning how to minimise risk.

By focusing on the reasons for carrying out a particular practical, teachers will help their students understand the subject better, to develop the skills of a scientist and to master the manipulative skills required for further study or jobs in STEM subjects.

The reformed A-levels in Biology, Chemistry and Physics separate the ways in which practical work is assessed. This is discussed in the next section.

## Fluency in science practical work

At the beginning of a Year 12 course, students will need support and guidance to build their confidence. This could involve, for example, breaking down practicals into discrete sections or being more explicit in instructions. Alternatively, a demonstration of a key technique followed by students copying may support their development. This could be a better starting point than 'setting students loose' to do it for themselves.

**Progression in the mastery of practical skills and techniques shows increasing independence and confidence.**

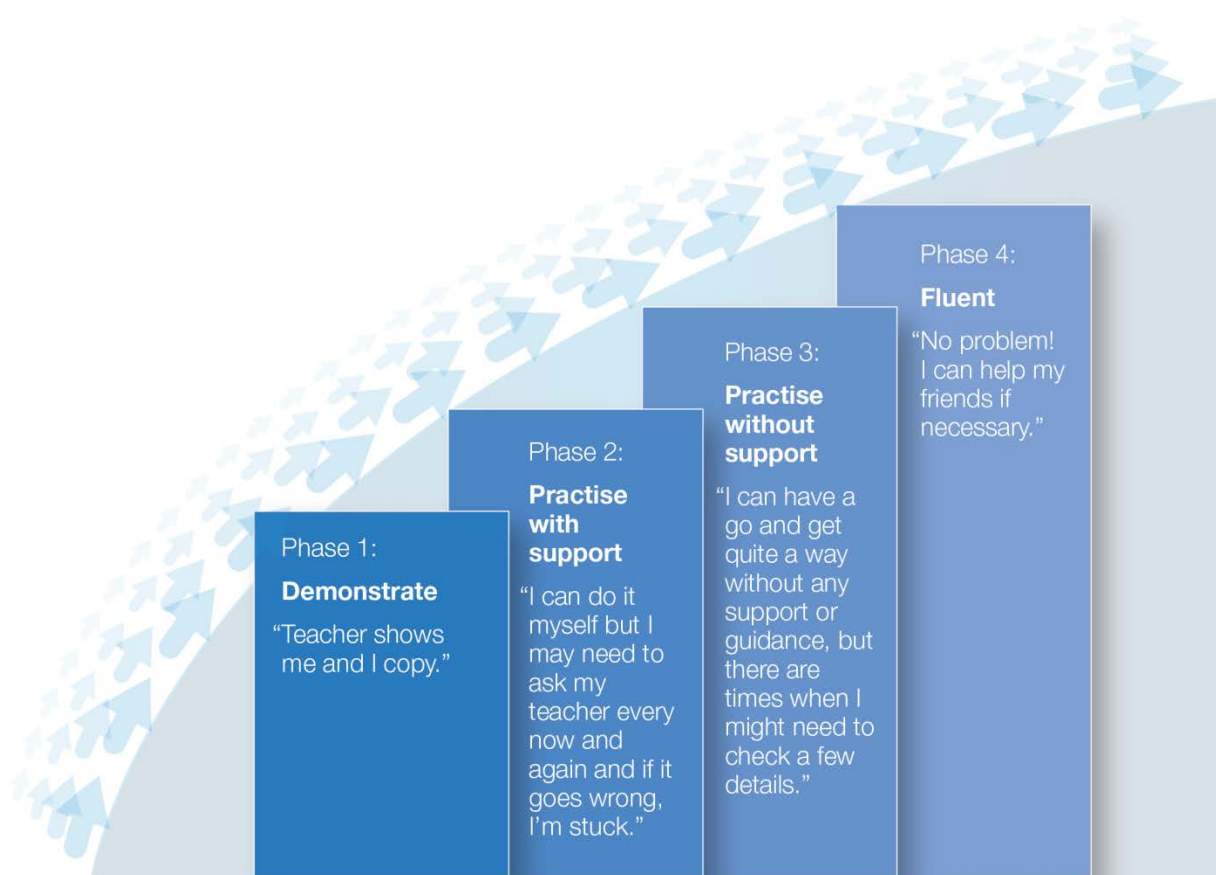

**Safety is always the responsibility of the teacher. No student should be expected to assess risks and then carry out their science practical without the support and guidance of their teacher.**

## Practical work in reformed A-level Biology, Chemistry and Physics

---

### Statement on practical work by Glenys Stacey, Chief Regulator at Ofqual, April 2014

“Practical work and experimentation is at the heart of science. It matters to science students, their teachers and their future universities and employers. But A-level students do not always have the chance to do enough of it.

Practical work counts for up to 30 per cent of the final grades and the vast majority of students get excellent marks for it, but still many enter university without good practical skills.

It is possible to do well in science A-levels without doing sufficient or stretching hands-on science, and other pressures on schools can make it difficult for science teachers to carve out enough time and resource to do it if students can get good A-level grades in any event. That is not right – so why is it so?

Students are assessed and marked on their performance in set tasks, but these are generally experiments that are relatively easy to administer and not particularly stretching. It has proved extremely difficult to get sufficient variety and challenge in these experiments, and so students do well even if they have not had the opportunity to do enough varied and stretching experimentation, and learn and demonstrate a variety of lab skills. What to do?

In future, science A-level exams will test students’ understanding of experimentation more so than now. Those who have not had the chance to design, conduct and evaluate the results from a good range of experiments will struggle to get top grades in those exams. They will also be required to carry out a minimum of 12 practical activities across the two year course – practical activities specific to their particular science, and that are particularly valued in higher education. Students will receive a separate grade for their practical skills (a pass/fail grade).

These reforms should place experimentation and practical skills at the heart of science teaching, where they should be. Students going to university to study a science are more likely to go well prepared. The reforms will also change the game for science teachers, enabling them to teach science in a more integrated and stimulating way and with more hands on science. Teachers will be able to say with justification that, without sufficient time and effort put into lab work, their students will struggle to get the grades they deserve.”

Glenys Stacey, Chief Regulator

[The Ofqual blog: Practical Science.](#)

**This contains public sector information licensed under the Open Government License v.3.0.**

The reformed AS and A-level specifications will have **no** direct assessment of practical work that contributes to the AS or A-level grades.

There are **two** elements to the practical work that students must carry out in their study of A-level Biology, Chemistry and Physics:

### Apparatus and techniques

These have been agreed by all Awarding Organisations (AOs), so all students will have experienced similar practical work after following a science A-level course.

All

Examples:

- use of a light microscope at high power and low power, including use of a graticule
- purify a solid product by recrystallization
- use a laser or light source to investigate characteristics of light.

### 12 required practical activities

These have been specified by AQA. They cover the apparatus and techniques for each subject – so teachers do not have to worry about whether they are all covered.

AQA

Examples:

- use of aseptic techniques to investigate the effect of antimicrobial substances on microbial growth
- carry out simple test-tube reactions to identify cations and anions in aqueous solution
- determination of  $g$  by a free-fall method.

These will be assessed in two ways:

1. Questions in the written papers, assessed by AQA

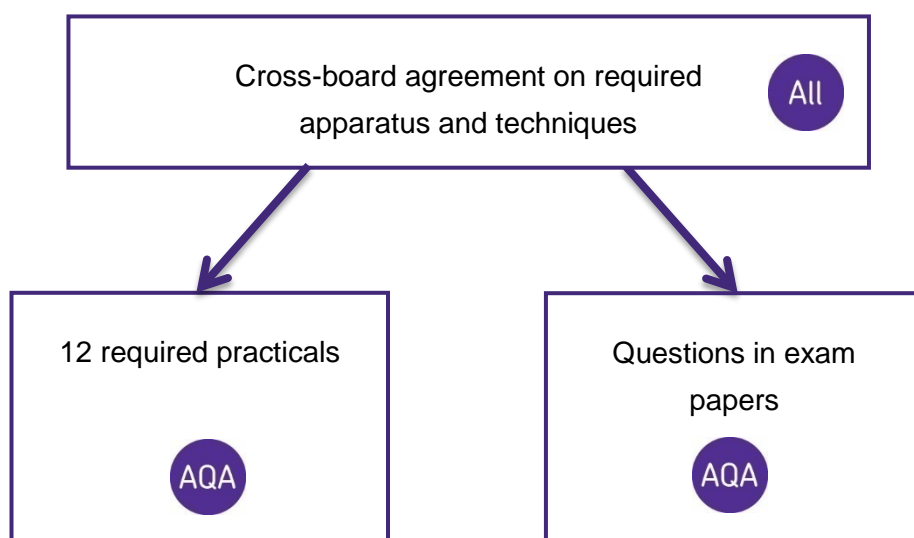



2. The practical endorsement, directly assessed by teachers.

Teachers will assess student competence at carrying out practical work. They will assess each student on at least 12 different occasions. This could be whilst teaching the 12 required practicals, or could be during other practical work of sufficient challenge.

At the end of the course, teachers will decide whether or not to award a pass in the endorsement of practical skills. The teacher must be confident that the student has shown a level of mastery of practical work **good enough for the student to go on to study science subjects at university.**

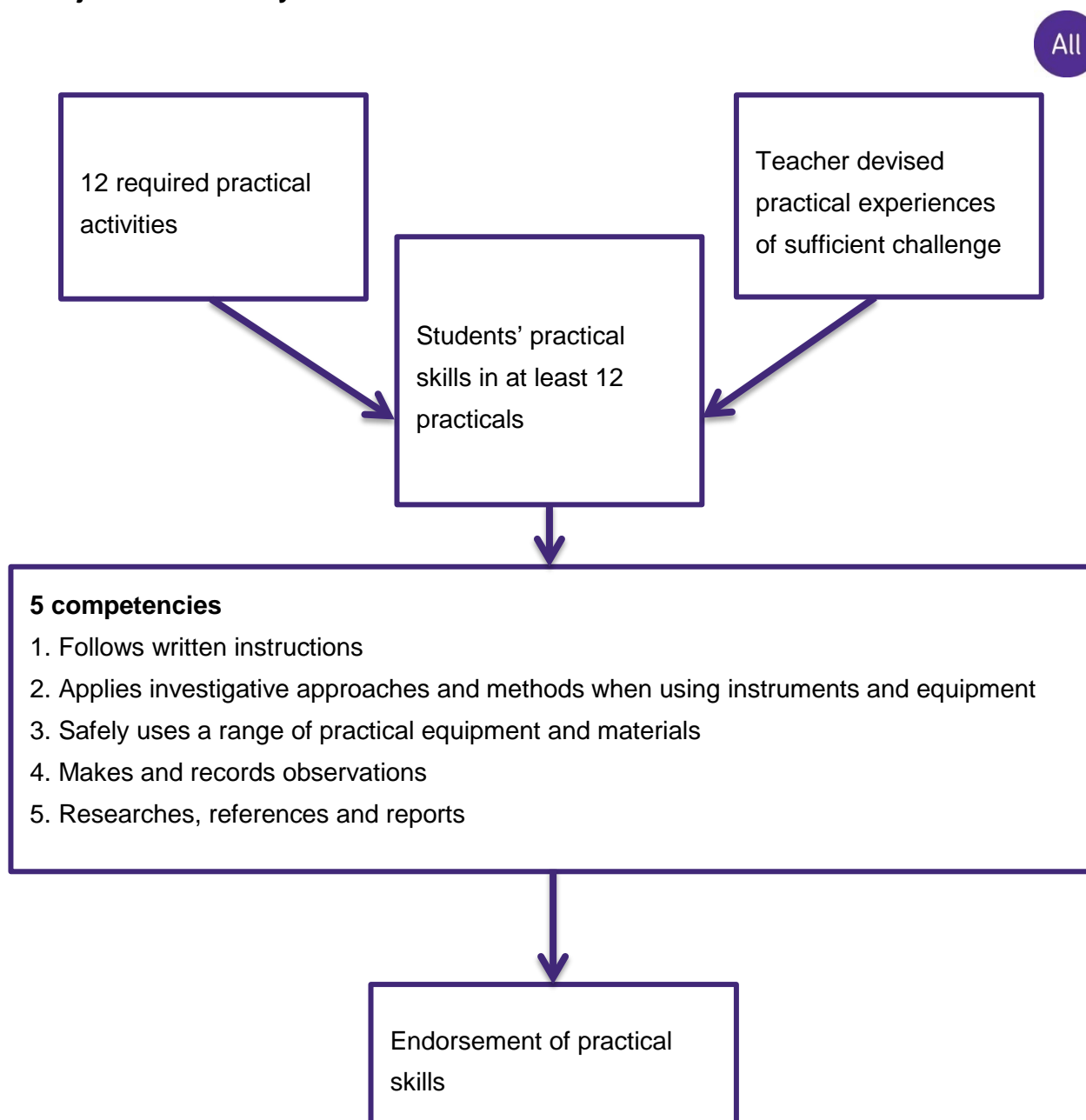

---

## Students who miss a required practical activity

### Written exam papers

The required practical activities are part of the specification. As such, exam papers could contain questions about the activities and assume that students understand those activities. A student who misses a particular practical activity may be at a disadvantage when answering questions in the exams.

It will often be difficult to set up a practical a second time for students to catch up, although if at all possible an attempt should be made. Teachers will need to decide on a case by case basis whether they feel it is important for the student to carry out that particular practical. This is no different from when teachers make decisions about whether to re-teach a particular topic if a student is away from class when it is first taught.

### Endorsement

To fulfil the requirements of the endorsement, every student must carry out a minimum of 12 practicals. A student who misses one of the required practicals must carry out another practical to be able to gain the endorsement.

In most cases, this can be any experiment of A-level standard. However, students must have experienced use of each of the apparatus and techniques. In some cases, a particular apparatus and technique is only covered in one required practical activity. If a student misses that activity, the teacher will need to provide an opportunity for the student to carry out a practical that includes that activity. The list below shows the apparatus and techniques that are covered by one activity only, as well as alternatives to the required practical.

There is a possibility that the student could be asked questions about the required activity in written papers that would not be fully understood by carrying out the alternative. This should be considered when deciding whether to repeat the required activity.

If a student misses this required practical activity...	...they won't have covered this apparatus and technique.	Other practicals within an A-level Biology course involving this skill
2. Preparation of stained squashes of cells from plant root tips; set-up and use of an optical microscope to identify the stages of mitosis in these stained squashes and calculation of a mitotic index.	d. use of light microscope at high power and low power, including use of a graticule.	Examination of permanent mounts of any tissue, related to specification content, in which students use both high- and low-power objective lenses of an optical microscope and use a stage micrometer and eyepiece graticule to measure the actual size of cells.
7. Use of chromatography to investigate the pigments isolated from leaves of different plants, eg leaves from shade-tolerant and shade-intolerant plants or leaves of different colours.	g. separate biological compounds using thin layer/paper chromatography or electrophoresis.	Separation of any aqueous mixture related to specification content, eg, sugars or amino acids, by paper or thin layer chromatography.  Extraction of 'chlorophyll' from a plant or alga and separation of its constituent pigments by paper or thin layer chromatography. Separation of DNA fragments by electrophoresis.
12. Investigation into the effect of a named environmental factor on the distribution of a given species.	k. use of sampling techniques in fieldwork.	Use of random quadrats to investigate the pattern of distribution of a named sessile organism. Examples include daisies in a school playing field, epiphytes on the bark of a tree and limpets on a rocky shore. Use of the mark-release-recapture technique to estimate the size of a population of woodlice in a garden or school playground/sports field.

## Practical skills assessment in question papers

The AS and A-level papers will contain the following types of questions which relate to practical work:

1. Questions set in a practical context, where the question centres on the science, not the practical work.

### Example (A-level Biology Specimen Paper 1)

Scientists measured translocation in the phloem of trees. They used carbon dioxide labelled with radioactive  $^{14}\text{C}$ .

They put a large, clear plastic bag over the leaves and branches of each tree and added  $^{14}\text{CO}_2$ . The main trunk of the tree was not in the plastic bag.

At regular intervals after adding the  $^{14}\text{CO}_2$  to the bag, the scientists measured the amount of  $^{14}\text{CO}_2$  released from the top and bottom of the main trunk of the tree. On the surface of the trunk of these trees, there are pores for gas exchange.

Figure 7 shows the scientists' results.

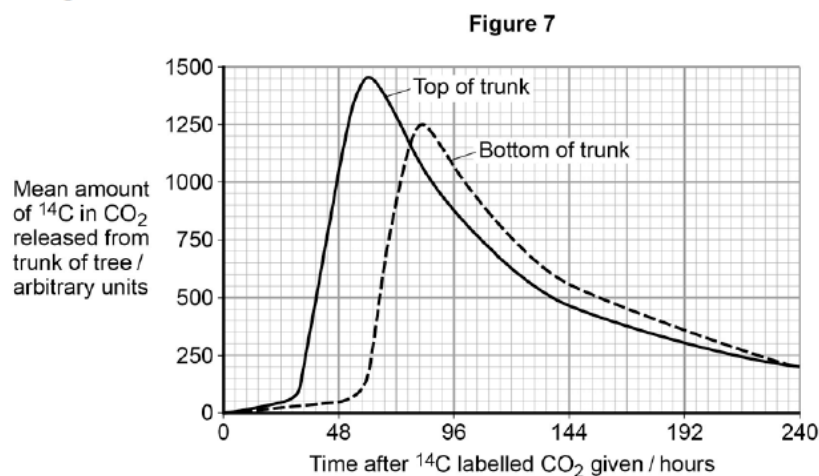

- 0 9 . 2 Name the process that produced the  $^{14}\text{CO}_2$  released from the trunk. [1 mark]

\_\_\_\_\_

- 0 9 . 3 How long did it take the  $^{14}\text{C}$  label to get from the top of the trunk to the bottom of the trunk? Explain how you reached your answer. [2 marks]

\_\_\_\_\_  
\_\_\_\_\_

- 0 9 . 4 What other information is required in order to calculate the mean rate of movement of the  $^{14}\text{C}$  down the trunk? [1 mark]

\_\_\_\_\_

These questions are set in the context of practical work that has been carried out.

However, the questions relate more to the basic Biology behind the situation, or mathematical skills.

### Example (AS Chemistry Specimen Paper 1)

- 4 Colourless solutions of  $X(aq)$  and  $Y(aq)$  react to form an orange solution of  $Z(aq)$  according to the following equation.

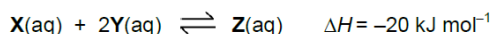

A student added a solution containing 0.50 mol of  $X(aq)$  to a solution containing 0.50 mol of  $Y(aq)$  and shook the mixture.  
After 30 seconds, there was no further change in colour.  
The amount of  $Z(aq)$  at equilibrium was 0.20 mol.

- 0 4 . 1 Deduce the amounts of  $X(aq)$  and  $Y(aq)$  at equilibrium.

[2 marks]

Amount of  $X(aq)$  = \_\_\_\_\_ mol      Amount of  $Y(aq)$  = \_\_\_\_\_ mol

This question requires an understanding of the underlying chemistry, not the practical procedure undertaken.

### Example (A-level Physics Specimen Paper 3)

- 0 2 . 6 The experiment is performed with a capacitor of nominal value  $680 \mu\text{F}$  and a manufacturing tolerance of  $\pm 5\%$ . In this experiment the charging current is maintained at  $65 \mu\text{A}$ . The data from the experiment produces a straight-line graph for the variation of pd with time. This shows that the pd across the capacitor increases at a rate of  $98 \text{ mV s}^{-1}$ .

Calculate the capacitance of the capacitor.

[2 marks]

capacitance = \_\_\_\_\_  $\mu\text{F}$

This question is set in a practical context, and particular readings need to be used to calculate the answer, but the specific practical set-up is not important.

2. Questions that require specific aspects of a practical procedure to be understood in order to answer a question about the underlying science.

### Example (A-level Biology Specimen Paper 2)

8 Chloroplasts contain chlorophyll a and chlorophyll b. Scientists found tobacco plants with a mutation that caused them to make more chlorophyll b than normal tobacco plants. They investigated the effect of this mutation on the rate of photosynthesis.

The scientists carried out the following investigation.

- They grew normal and mutant tobacco plants. They grew some of each in low light intensity and grew others in high light intensity.
- They isolated samples of chloroplasts from mature plants of both types.
- Finally, they measured oxygen production by the chloroplasts they had isolated from the plants.

Figure 7 shows the scientists' results.

**Figure 7**

0 8 . 1 Explain why the scientists measured the rate of production of oxygen in this investigation. [2 marks]

This question requires the students to understand how oxygen production can be used as a proxy measure for photosynthesis, but no other details of the practical procedure are important.

### Example (AS Chemistry Specimen Paper 2)

0 1 . 4 The effect of gentle heat on maleic acid is shown below.

A student predicted that the yield of this reaction would be greater than 80%.

In an experiment, 10.0 g of maleic acid were heated and 6.53 g of organic product were obtained.

Is the student correct? Justify your answer with a calculation using these data. [2 marks]

To answer this question, the student must understand the process of yield calculation (which will have been gained through practical work), but again the details of the practical procedure are unimportant.

3. Questions directly on the required practical procedures.

**Example (AS Biology Specimen Paper 1)**

2 A technician investigated the effect of temperature on the rate of an enzyme-controlled reaction. At each temperature, he started the reaction using the same volume of substrate solution and the same volume of enzyme solution.

Figure 2 shows his results.

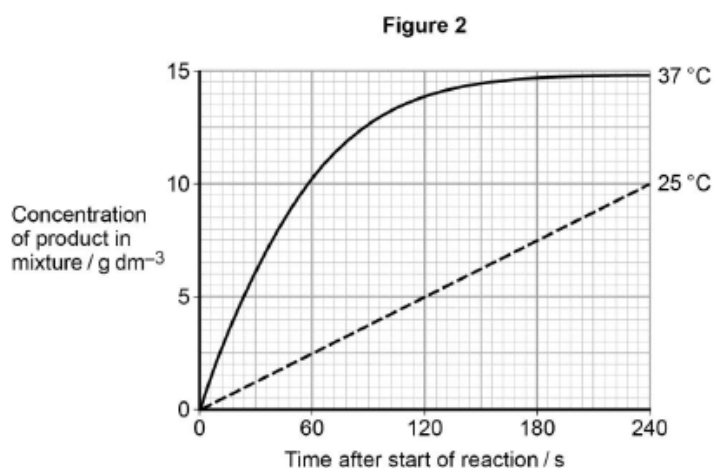

0 2 . 1 Give one other factor the technician would have controlled.

[1 mark]

---

---

0 2 . 2 Calculate the rate of reaction at 25 °C.

[2 marks]

Similarly, in this example, the students should have done a very similar experiment.

The first question is simple recall of the factors involved in the rate of enzyme controlled reactions.

The second requires the calculation of a gradient, which is a skill students will have learned through their practical and other work.

### Example (A-level Chemistry Specimen Paper 3)

3 A peptide is hydrolysed to form a solution containing a mixture of amino acids. This mixture is then analysed by silica gel thin-layer chromatography (TLC) using a toxic solvent. The individual amino acids are identified from their  $R_f$  values.

Part of the practical procedure is given below.

1. **Wearing plastic gloves to hold a TLC plate**, draw a pencil line 1.5 cm from the bottom of the plate.
2. Use a capillary tube to apply a very small drop of the solution of amino acids to the mid-point of the pencil line.
3. Allow the spot to dry completely.
4. In the developing tank, add the developing solvent to **a depth of not more than 1 cm**.
5. Place your TLC plate in the developing tank.
6. Allow the developing solvent to rise up the plate **to the top**.
7. Remove the plate and quickly mark the position of the solvent front with a pencil.
8. Allow the plate to dry **in a fume cupboard**.

0 3 . 1 Parts of the procedure are in bold text.

For each of these parts, consider whether it is essential and justify your answer. [4 marks]

---

Students who have completed the related required practical will have a greater understanding of each of the steps in the procedure and will be able to explain each in turn.

4. Questions applying the skills from the required practical procedures and the apparatus and techniques list.

### Example (A-level Chemistry Specimen Paper 3)

0 1 . 3 The boiling points of the organic compounds in a reaction mixture are shown in Table 1.

Table 1

Compound	ethanol	ethanal	ethanoic acid
Boiling point / °C	78	21	118

Use these data to describe how you would obtain a sample of ethanal from a mixture of these three compounds. Include in your answer a description of the apparatus you would use and how you would minimise the loss of ethanal. Your description of the apparatus can be either a description in words or a labelled sketch. [5 marks]

This question expects students to understand distillation which is one of the required practicals. It is not necessary for students to have carried out this precise experiment to understand the requirements.



## Example (AS Physics Specimen Paper 2)

0 2

Data analysis question

Capillary action can cause a liquid to rise up a hollow tube. Figure 3 shows water that has risen to a height  $h$  in a narrow glass tube because of capillary action.

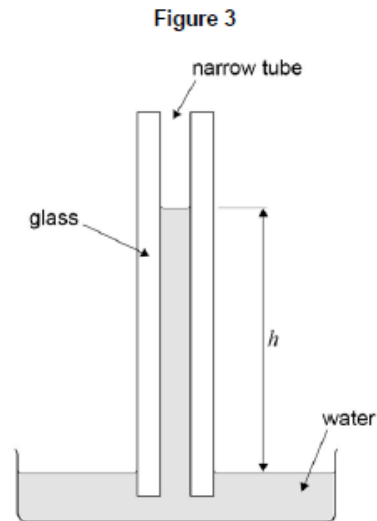
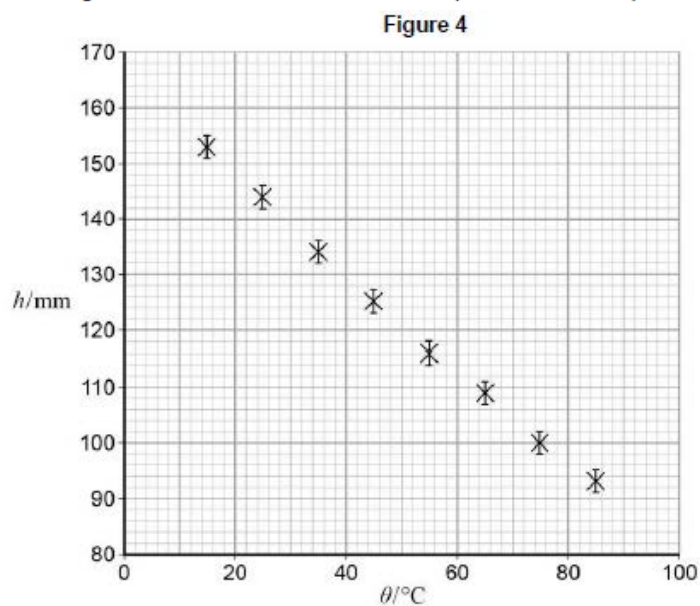

Figure 4 shows the variation of  $h$  with temperature  $\theta$  for this particular tube.



The uncertainty in the measurement of  $h$  is shown by the error bars. Uncertainties in the measurements of temperature are negligible.

0 2 . 1 Draw a best-fit straight line for these data (Figure 4).

[1 mark]

0 2 . 2 It is suggested that the relationship between  $h$  and  $\theta$  is

$$h = h_0 - (h_0 k) \theta$$

where  $h_0$  and  $k$  are constants.

Determine  $h_0$ .

[1 mark]

This question requires students to apply the data analysis skills gained through their practical work and apply it to an unusual situation.

## Guidelines for supporting students in practical work

Developed in collaboration with NFER and CLEAPSS

Clarify the importance of keeping a lab book or other records of practical work

Explain that students need a record of their achievements to guide their learning. Lab books also can be an opportunity to develop a skill used both by scientists and in business. They allow students to accurately and clearly record information, ideas and thoughts for future reference which is a very useful life skill.

Warn students against plagiarism and copying

Explain the meaning of the term plagiarism and that the use of acknowledged sources is an encouraged and acceptable practice, but trying to pass off other people's work as their own is not, and will not help them learn. Show students how sources should be cited.

Explain the learning criteria for each skill

This will help students learn and allow them to know when they have met the criteria. The student lab book contains the criteria, but they own the process and have the responsibility for collecting appropriate evidence of success.

Use clearly defined learning outcomes

For example, if you are running a practical session to teach students how to use a microscope and staining techniques safely and efficiently, then make sure they know why they are learning this. This will also make it much easier for them to know when they have met the criteria.

Start with simple tasks initially

Students need to become confident with the apparatus and concepts of practical work before they can proceed to more complicated experiments. It may be more effective to start with simple manipulation skills and progress to the higher order skills.

Teach practical work in your preferred order

Teach the skills as you see fit and suit your circumstances – the assessment process is aimed to be flexible and help you teach practical work, not to dictate how it should be done.

Use feedback and peer assessment

Feedback is essential to help students develop skills effectively. Allowing self and peer review will allow time for quality feedback as well as provide powerful learning tools. However, this is a decision for teachers. The scheme is designed to be flexible while promoting best practice.

Research shows that feedback is the best tool for learning in practical skills. Students who normally only receive numerical marks as feedback for work will need to be trained in both giving and receiving comment-based feedback. Provided it is objective, focused on the task and meets learning outcomes, students will quickly value this feedback.

Feedback does not need to be lengthy, but it does need to be done while the task is fresh in the students' mind. Not everything needs written feedback but could be discussed with students, either individually or as a class. For example, if a teacher finds that many students cannot calculate percentage change, the start of the next lesson could be used for a group discussion about this.

The direct assessment of practical work is designed to allow teachers to integrate student-centred learning (including peer review), into day-to-day teaching and learning. This encourages critical

---

skills. Research indicates these are powerful tools for learning. For example, teachers could ask students to evaluate each other's data objectively. The students could identify why some data may be useful and some not. This can be a very good way of getting students to understand why some conventions are used, and what improves the quality of results. This also frees up marking time to concentrate on teaching.

### Don't give marks

We have deliberately moved away from banded criteria and marks to concentrate on the mastery of key practical competencies. The purpose of marking should be changed to emphasise learning. Students should find it easier to understand and track their progress, and focus their work. We would expect most students, with practice and the explicit teaching of skills and techniques, to succeed in most competencies by the end of the course.

### Use group work

This is a very useful skill, allowing students to build on each other's ideas. For example, planning an experiment can be done as a class discussion. Alternatively, techniques such as snowballing can be used, in which students produce their own plan then sit down in a small group to discuss which are the best collective ideas. From this, they revise their plan which is then discussed to produce a new 'best' plan.

## Use of lab books

Students do **not** need to write up every practical they do in detail. However, it is good practice to have a record of all they do. A lab book could contain this. It is a student's personal book and may contain a range of notes, tables, jottings, reminders of what went wrong, errors identified and other findings. It is a live document that can function as a learning journal.

Lab books are **not** a requirement of the CPAC endorsement or the AQA AS and A-level specifications in Biology, Chemistry or Physics. They are highly valued by colleagues in higher education and are an easy way for students to demonstrate their mastery of Competence 5 "Researches, references and reports".

Each institution has its own rules on lab book usage. The following guidelines are based on those from a selection of companies and universities that use lab books. They are designed to help students and teachers in preparing to use lab books for university but do not represent the only way that books could be used for A-level sciences. Teachers may wish to vary the following points to suit their purposes.

### The purpose of a lab book

A lab book is a complete record of everything that has been done in the laboratory. As such, it becomes important both to track progress of experiments, and also, in industry and universities, to prove who developed an idea or discovered something first.

A lab book is a:

- source of data that can be used later by the experimenter or others
- complete record of what has been done so that experiments could be understood or repeated by a competent scientist at some point in the future
- tool that supports sound thinking and helps experimenters to question their results to ensure that their interpretation is the same one that others would come to
- record of why experiments were done.

### Type of book

Spiral bound notebooks are not recommended as it is too easy to rip a page out and start again. It is generally advisable that a lab book has a cover that won't disintegrate the moment it gets slightly wet. A lab book is often a hard-backed book with bound pages.

### Style

Notes should be recorded as experiments are taking place. They should not be a "neat" record written at a later date. However, they should be written clearly, in legible writing and in language which can be understood by others.

Many lab books are used in industry as a source of data, and so should be written in indelible ink.

To ensure that an observer can be confident that all data are included when a lab book is examined, there should be no blank spaces. Mistakes should be crossed out and re-written. Numbers should not be overwritten, erased, or covered over. Pencil should not be used for anything other than graphs and diagrams.

---

Each page should be dated

Worksheets, graphs, printed information, photographs and even flat “data” such as chromatograms or TLC plates can all be stuck into a lab book. They should not cover up any information as this is not compatible with photocopying. Anything glued in should lie flat and not be folded.

## Content

Generally, lab books will contain:

- title and date of experiment
- notes on the objectives of the experiment (eg apparatus and techniques covered or CPAC assessed)
- notes on the method, including all details (eg temperatures, volumes, settings of pieces of equipment) with justification where necessary
- estimates of the uncertainty of measurements
- sketches of how equipment has been set up can be helpful. Photographs pasted in are also acceptable
- data and observations input to tables (or similar) while carrying out the experiment
- calculations – annotated to show thinking
- graphs and charts
- summary, discussions and conclusions
- cross-references to earlier data and references to external information.

This list and its order are not prescriptive. Many experiments change as they are set up and trials run. Often a method will be given, then some data, then a brief mention of changes that were necessary, then more data and so on.

## Cross-board statement on CPAC

### Common Practical Assessment Criteria (CPAC)

The assessment of practical skills is a compulsory requirement of the course of study for A-level qualifications in biology, chemistry and physics. It will appear on all students' certificates as a separately reported result, alongside the overall grade for the qualification. The arrangements for the assessment of practical skills are common to all AOs.

- A minimum of 12 practical activities to be carried out by each student which, together, meet the requirements of Appendices 5b (Practical skills identified for direct assessment and developed through teaching and learning) and 5c (Use of apparatus and techniques) from the prescribed subject content, published by the Department for Education. The required practical activities will be defined by each AO in their specification.
- Teachers will assess students using Common Practical Assessment Criteria (CPAC) issued jointly by the AOs. The CPAC are based on the requirements of Appendices 5b and 5c of the subject content requirements published by the Department for Education, and define the minimum standard required for the achievement of a pass.
- Each student will keep an appropriate record of their practical work, including their assessed practical activities.
- Students who demonstrate the required standard across all the requirements of the CPAC will receive a 'pass' grade.
- There will be no separate assessment of practical skills for AS qualifications.
- Students will answer questions in the AS and A level examination papers that assess the requirements of Appendix 5a (Practical skills identified for indirect assessment and developed through teaching and learning) from the prescribed subject content, published by the Department for Education. These questions may draw on, or range beyond, the practical activities included in the specification.

## Criteria for the assessment of practical competency

Competency	Practical mastery
	<p>In order to be awarded a pass, a student must, by the end of the practical science assessment, consistently and routinely meet the criteria in respect of each competency listed below. A student may demonstrate the competencies in any practical activity undertaken as part of that assessment throughout the course of study.</p> <p>Students may undertake practical activities in groups. However, the evidence generated by each student must demonstrate that he or she independently meets the criteria outlined below in respect of each competency. Such evidence:</p> <ul style="list-style-type: none"> <li>a. will comprise both the student's performance during each practical activity and his or her contemporaneous record of the work that he or she has undertaken during that activity, and</li> <li>b. must include evidence of independent application of investigative approaches and methods to practical work.</li> </ul>
1. Follows written procedures	a. Correctly follows written instructions to carry out experimental techniques or procedures.
2. Applies investigative approaches and methods when using instruments and equipment	<ul style="list-style-type: none"> <li>a. Correctly uses appropriate instrumentation, apparatus and materials (including ICT) to carry out investigative activities, experimental techniques and procedures with minimal assistance or prompting.</li> <li>b. Carries out techniques or procedures methodically, in sequence and in combination, identifying practical issues and making adjustments when necessary.</li> <li>c. Identifies and controls significant quantitative variables where applicable, and plans approaches to take account of variables that cannot readily be controlled.</li> <li>d. Selects appropriate equipment and measurement strategies in order to ensure suitably accurate results.</li> </ul>
3. Safely uses a range of practical equipment and materials	<ul style="list-style-type: none"> <li>a. Identifies hazards and assesses risks associated with these hazards, making safety adjustments as necessary, when carrying out experimental techniques and procedures in the lab or field.</li> <li>b. Uses appropriate safety equipment and approaches to minimise risks with minimal prompting.</li> </ul>

<p>4. Makes and records observations</p>	<p>a. Makes accurate observations relevant to the experimental or investigative procedure.</p> <p>b. Obtains accurate, precise and sufficient data for experimental and investigative procedures and records this methodically using appropriate units and conventions.</p>
<p>5. Researches, references and reports</p>	<p>a. Uses appropriate software and/or tools to process data, carry out research and report findings.</p> <p>b. Cites sources of information demonstrating that research has taken place, supporting planning and conclusions.</p>



---

## Extra information on the endorsement

---

The information below is based on the cross-board agreements, but is not in every case cross-board agreed wording.

### 'Consistently and routinely'

Teachers should be confident that their students can demonstrate a particular competence going forwards. This means that demonstrating a competence once to the expected standard is unlikely to be enough, but there is no stipulated number of times that each competence must be demonstrated. The teacher should use professional judgement when holistically assessing their students at the end of the course.

### Observing differences in standard over time

There is an expectation that students will improve in their skills and abilities in practical work throughout a two-year course. An adviser attending a school in the earlier part of the course would expect to see students working at a lower level than the same students would be working at by the end of the course.

There are many different ways of tracking students' skills development towards competence. Advisers will not expect to see any particular method of tracking or showing this development during visits. Advisers will discuss tracking with teachers in order to become confident that the teachers understand the standard expected at the end of the course and that their planning supports students' skills progression.

### Demonstrations

Demonstrations cannot be substituted for any of the required practical activities. Teachers can demonstrate experiments when teaching new techniques, before students carry out the experiment in subsequent lessons. However, if CPAC 1 is being assessed, the instructions must not simply repeat what was shown in the demonstration.

### The link between the apparatus and techniques and CPAC

All students should have experienced use of each of the apparatus and techniques. Their competence in practical work will be developed through the use of these apparatus and techniques. However, students are not being assessed on their abilities to use a particular piece of equipment, but on their general level of practical competence.

### Simulations

Simulations are not acceptable for use in the place of the apparatus and techniques.

### Helping students during practical work

Teachers can help students during practical work, but the amount of guidance will be dependent on the criteria being assessed. For example, if a student was being assessed on CPAC 3, and needed to be reminded on the basics of safety, they could not be assessed as passing.

It may be appropriate to help students through spot demonstrations if the equipment or the technique is new or unusual.

The amount of help would depend on when in the course the practical work was taking place. For example, at the beginning of Year 12 the teacher would be likely to be giving a lot of guidance, and tasks would include a lot of support. By the end of Year 13, there is likely to be minor prompting to help students as they become more confident and competent.

---

## Language used by students

In written exams, students are expected to use scientific language that corresponds to the glossary of terms in this handbook. Whilst doing practical work, students should be encouraged to use the correct terms (such as discussing if results are 'accurate', 'precise', 'repeatable' etc), but should not be penalised for using incorrect vocabulary verbally. This is because the assessment is about the students' abilities in practical work, not their use of terms.

## Standardisation within centres

It is expected that there is communication and training within centres such that the outcomes for learners are consistent, independent of teaching staff. Whilst the opportunity for standardisation is not the same as with internally marked controlled assessments, there should be dialogue and the possibility for observations of other staff to ensure the comparability of outcomes. The common requirements of the Practical Endorsement allow centres to assure that the criteria for the Common Practical Assessment Criteria (CPAC) are being implemented and recorded in all situations, including those where A-levels from different AOs are being delivered by one centre.

## Candidate and centre records

There is no requirement for centres to retain candidate records. Candidate records are only required for review at the time of the monitoring visit. Similarly, there is no requirement for centres to retain centre records after completion of the course.

## Certificates

Students will either have 'Pass' or 'Not classified' recorded on their certificate for the endorsement.

## Resit candidates

Resit candidates who have passed the requirements for the practical endorsement may carry this result forward. They are not required to repeat the practical activities to achieve a pass grade, but may choose to repeat them along with the teaching and learning to increase their knowledge and understanding for the written exams.

JCQ are organising a national record of candidates who have achieved a pass in the practical endorsement, which may be accessed by an AO to assure that a candidate is eligible for the carry forward of their practical endorsement pass. This will include candidates who achieve an unclassified U grade in the exam and who will not have the outcome of the practical endorsement certificated.

Teachers who accept resit candidates from a different school, college or tuition centre should insist on having sight of the candidate certificate as proof of practical endorsement pass.

If the candidate is also resitting the practical endorsement, as they have failed to meet the pass standard in all CPAC criteria previously, teachers will need to assess all CPAC, not just areas of weakness highlighted previously.

## Reasonable adjustments

The [JCQ document \*Access Arrangements and Reasonable Adjustments\*](#) sets out arrangements for access arrangements for all assessments.

The arrangements applicable to the endorsement must not compromise the objectives of the assessment. So, for example, it may be reasonable for a student to have a reader or extra time while being assessed against CPAC 1. Students would be demonstrating their ability to follow instructions in the form the students were used to receiving them.

CPAC 2 and 3 make reference to the use of instruments, equipment and materials. The use of a practical assistant for a student with very poor motor coordination or a severe visual impairment could potentially compromise the purpose of the assessment (to develop manipulative skills).

Teachers should work with the special educational needs coordinator to determine which arrangements are appropriate and reasonable.

### Tutorial colleges, private entries and home schooling

The provision of the Practical Endorsement and associated practical activities is a regulatory requirement. Any centre not providing opportunities to demonstrate the competences for a minimum of twelve practical activities, is in breach of the regulations for the reformed GCE Advanced level science qualifications. The same applies to centres that have not had a monitoring visit to confirm that they are assessing their students correctly against the CPAC. These breaches are subject to a series of sanctions from the regulator such as those for malpractice or maladministration, which will be instigated by the AO conducting monitoring of the centre, and communicated with all other AOs.

Candidates resitting the assessment at tutorial colleges may have demonstrated competence in all the practical requirements at a previous centre. Providing that centre passed its monitoring visit, the evidence of prior completion allows entry for the resit with a carry-forward of the practical endorsement result.

Private candidates can be entered for exams at a centre even if they are not enrolled there. Private candidates may be home-schooled, receiving private tuition or may be self-taught. The Practical Endorsement is an essential part of the course and will allow candidates to develop skills for further study or employment as well as imparting important knowledge that is part of the specification. Private candidates should have the opportunity to complete the Practical Endorsement and should, therefore, ensure that they are registered with a centre that has passed a monitoring visit and has this provision available. The centre may charge for this facility and it is recommended that any such arrangement is made early in the course.

### New centres

Any new centre starting to deliver one of the sciences at GCE A-level should notify the AO with whom they intend to make entries so that a monitoring visit can be scheduled during the teaching of the first cohort. Contact details are as follows:

AO	Contact address
AQA	<a href="mailto:MonitoringReports2017@aqa.org.uk">MonitoringReports2017@aqa.org.uk</a>
Pearson (Edexcel)	<a href="mailto:TeachingScience@pearson.com">TeachingScience@pearson.com</a>
Eduqas	<a href="mailto:matthew.roberts@eduqas.co.uk">matthew.roberts@eduqas.co.uk</a>
OCR	<a href="mailto:Science@OCR.org.uk">Science@OCR.org.uk</a>

### Switching AOs

AOs will use entry data from summer 2017 to make contact with centres who they believe to be following their specification. Should a centre have switched AO, they should notify the monitor when they make contact. The monitor will then pass that information to the new board to allow the board for the course being delivered to carry out the visit.

---

## Monitoring visits

---

We are committed to making the monitoring process a supportive one. Monitoring is not like an Ofsted visit, it's an opportunity for students to show off their learning, and for teachers to show their teaching. It isn't a 'big stick' - it should be positive and helpful.

We refer to our monitors as advisers

Advisers will be looking to confirm two things:

- that schools are **compliant** with the **rules**
- that teachers are **assessing** students at the correct **standard**.

All schools have now been monitored for one subject by one of the boards during the first two years of the course. For example, if a school is taking Biology with AQA, while Chemistry and Physics with other boards, AQA have only visited the Biology department, and another board may have visited Chemistry or Physics. Larger schools and colleges (who tend to have separate departments) will have been visited three times, one visit to each department. AQA's first visits took place between January and April 2016. Remaining first visits took place between September 2016 and May 2017. A similar pattern of visits is now intended throughout the lifetime of the specification.

### Cross-board agreed process and code of conduct

Process		
1	AO	Collates all visits and outcomes from previous exam series and agrees on allocation and subject for monitoring.
2	AO	Arranges monitoring visits and allocates advisers.
3	Adviser	Visits centre. Feeds back to AO and school.

---

## Training

Training on the standard is free and [available on our website](#). **The Lead Teacher for each science must undertake this compulsory training** and disseminate information to their subject team as requested by their AO.

Lead Teachers are not required to be the same person as previously notified to JCQ or the AOs, and there is no need to notify JCQ or the AO of any such staffing change.

Lead Teachers continuing in post do not have to repeat the training, but will want to ensure that any staff who are new to their centre are fully aware of the requirements of the Practical Endorsement.

## Notice of monitoring

Each AO is expected to give schools or colleges at least two weeks' notice of monitoring visits. Where possible, AOs may take into account the school/college's timetables, but on most occasions it will be necessary for the school/college to make arrangements to allow the adviser to observe a practical lesson.

Materials required by the adviser on the day of the visit:

- documented plans to carry out sufficient practical activities which meet the requirements of CPAC, incorporating skills and techniques detailed in appendix 5, over the course of the A-level.
- a record of each practical activity undertaken and the date when this was completed
- a record of the criteria being assessed in that practical activity
- a record of student attendance
- a record of which student met the criteria and which did not
- student work showing evidence required for the particular task with date
- any associated materials provided for the practical activity, eg written instructions given

A timetable for the day and lists of people who the adviser will meet will also be required.

## Notes on evidence

- Evidence 1: although there is an expectation that planning to cover the full requirements of the endorsement should take place, plans may be in outline form if seen in the first year of the course.
- Evidence 2–6: will only be available after particular activities have taken place. The adviser should take a proportionate view on whether sufficient practical activities have taken place by the time of the visit.
- Evidence 7: a similarly proportionate view should be taken on this requirement.

## Before the day of monitoring

The adviser will communicate expectations with the centre, explaining the process, evidence required, the staff and students who will be observed or spoken to, and make arrangements for the day.

## On the day of monitoring

The timings of the monitoring visit will be discussed with the centre and will be dependent on the number of students.

---

Advisers will be expected to:

- meet the Lead Teacher for the endorsement of practical work for the subject being visited
- observe a lesson including a practical activity (which may or may not be one of the required practicals) during which students are assessed against the competencies
- discuss the teacher's assessment of the students in the class
- meet students and discuss the practical work that students have been doing (this may take place during the lesson if appropriate)
- view the work of students from lesson and other classes as per cross-board agreement
- view teachers' records of assessment of practical work
- follow all rules and procedures as required by the school.

Advisers may undertake formal or informal monitoring for an additional A-level subject when in a school or college where teachers are using the adviser's AO and have requested or agreed to such monitoring.

Advisers will under no circumstances:

- attempt to persuade teachers who are not currently teaching for the advisers' AO to change AOs
- attempt to persuade teachers to change AOs for GCSE or other courses
- collect information about teachers' names and AOs for subjects not taking exams with the adviser's board
- meet teachers for A-level subjects where the board used is not the adviser's board except where training is on another qualification where the teacher uses the adviser's board (for example, when a teacher uses different boards for GCSE and A-level)
- accept any sort of gifts from the school or teachers
- make notes that could be constituted as a "lesson observation", or feedback any judgement on teaching and learning to the teacher or school
- make audio, video or photographic records of students without prior explicit permission being granted by the senior leadership of the school and the parents of the students involved
- remove any original students' work from the centre at the end of the visit
- expect teachers to be using a particular method of planning, teaching or assessment.

## Feedback

The adviser will not give a formal judgement during the visit. Feedback will be received by the centre following review by the Lead adviser within two weeks of the visit.

A copy of the report will be sent electronically to the Head teacher, Lead Teacher and the exams officer. Please ensure your school server accepts email from AQA.

## Follow up actions

On occasion, the adviser may require supplementary evidence. These will generally be any actions that can take place remotely (for example emailing or sending evidence or documents to the adviser).

## Non-compliant centres

Centres that have not met the required standard will be reported to cross-board parties for follow up, which may include a follow up visit for the subject and/or monitoring for the other subjects.

---

## Safety

At all times the adviser should comply with health and safety regulations and the instructions of the teacher unless they would put the adviser at risk. The safety of students is the responsibility of the teacher. In particular, advisers should not be left alone with classes, especially where practical work is taking place. Advisers should be chaperoned at all times.

## Is the adviser role for you?

All of our advisers are practising teachers with a passion for practical work teaching. If you are interested in becoming one of our advisers, look out for our regular job advertisements.

---

## Evidence for the endorsement

---

Schools/colleges will be visited by an adviser who will agree with teachers a date for their visit. They will observe practical work taking place and discuss their views of the competencies exhibited by the students with the teacher present.

All

There should be no need to coach students for this visit, as it is the teachers' abilities to assess practical work that are being monitored, not the students' performance.

The following minimum documentation requirements have been agreed by the awarding bodies, and would be expected to be available to the adviser to view. There is currently no requirement for any of the following to be sent into the AO.

There are many ways of fulfilling these requirements. We believe that teachers should have the ability to choose the methods they use to collect this documentation. Different schools and colleges will find different ways to track this information depending on local needs. We will be providing example methods of tracking this information, but will not require teachers to use specific forms. Advisers will be trained by AQA and will accept the following methods, or alternatives which contain the required information.

AQA

### **1. Documented plans to carry out sufficient practical activities which meet the requirements of CPAC, incorporating skills and techniques detailed in appendix 5, over the course of the A-level.**

Appendix 5 here refers to the DfE subject criteria. The apparatus and techniques are listed in the specifications on the AQA website, as well as the next section in this handbook.

Teachers may wish to keep this information in the following ways:

- long-term schemes of work which include the required practicals (and any other practicals where teachers will be assessing students' competencies)
- timetables or lists of dates of each of the practicals
- sheets stuck in the front of students' lab books.

### **2. A record of each practical activity undertaken and the date when this was completed.**

### **3. A record of the criteria being assessed in that practical activity.**

These records could be kept:

- in long-term scheme of work, there may be bullet points after each practical identifying the competencies to be completed
- on student sheets, the competences that the teacher will be assessing could be detailed
- on tracking spreadsheets.



---

#### **4. A record of student attendance.**

This could be done via normal school systems if teachers feel that cross-referencing between SIMS or similar and their schemes of work allow them to be confident that all students have done each experiment.

Alternative methods could include:

- tracking spreadsheets
- teacher mark books
- sheets stuck at the front of students' lab books.

#### **5. A record of which student met the criteria and which did not.**

Examples of how this could be recorded:

- tracking spreadsheets
- on individual pieces of work/lab book pages
- an overview page per student at the front of lab books.

#### **6. Student work showing evidence required for the particular task with date.**

Teachers must be confident that they are able to assess the quality of students' work in accordance with the relevant CPAC criteria. For example:

- in lab books (allowing all practical work to be kept in one place)
- in students' folders, interspersed with their theory work (allowing the link between practical and theory to be highlighted)
- in computer-based systems
- on individual sheets collected at the end of practical sessions
- in pre-printed workbooks.

In each case, teachers must be able to locate students' work if an adviser visits the centre and asks to see it.

#### **7. Any associated materials provided for the practical activity, eg written instructions given.**

This could include:

- notes in lesson plans or schemes of work
- worksheets or workbooks
- notes made on tracking sheets.

These materials should allow an adviser to understand how much guidance students were given. For example, they could show that teachers gave students full details of an experiment, which would limit the ability of the students to demonstrate the ability to apply investigative approaches.

---

## Cross-board apparatus and techniques and AQA required activities

---

The apparatus and techniques lists for Biology, Chemistry and Physics are common to all boards. Students taking any specification in these subjects are expected to have had opportunities to use the apparatus and develop and demonstrate the techniques throughout the duration of the course.

The required practical activities in each subject are specific to AQA. We have written our specifications so that AS is co-teachable with the A-level specification. Therefore the first six required practicals are included in both specifications and the second six are A-level only.

Carrying out the 12 required practicals in the full A-level will mean that students will have experienced each of the expected apparatus and techniques. Teachers are encouraged to develop students' abilities by inclusion of other opportunities for skills development, as exemplified in the right-hand column of the content section of the specification.

Teachers are encouraged to vary their approach to the required practical activities. Some are more suitable for highly structured approaches that develop key techniques. Others allow opportunities for students to develop investigative approaches.

This list is not designed to limit the practical activities carried out by students. A rich practical experience for students will include more than the 12 required practical activities. The explicit teaching of practical skills builds students' competence. Many teachers will also use practical approaches to the introduction of content knowledge in the course of their normal teaching. Students' work in these activities can also contribute towards the endorsement of practical skills.

For the endorsement, all students must have experienced use of one of the alternatives in the apparatus and techniques list. For example, in Physics students can pass the endorsement if they have used digital or vernier scales.

However, to best prepare students for exams, teachers should ensure that all students understand each of the alternatives so they can answer questions on practical work that involve any of these.

**Therefore, all "or" statements in the apparatus and techniques list should be viewed as "and" statements for the written exams.**

We are keen to encourage teachers to use alternative methods that support students to develop their understanding of the apparatus and techniques statements. More detailed advice, additional activities and alternative methods can be found on the [CLEAPSS website](#).

Whichever method you use, it is your responsibility to check that you have covered all aspects of the apparatus and techniques criteria.

## Biology apparatus and techniques

Apparatus and techniques	
AT a	Use appropriate apparatus to record a range of quantitative measurements (to include mass, time, volume, temperature, length and pH).
AT b	Use appropriate instrumentation to record quantitative measurements, such as a colorimeter or photometer.
AT c	Use laboratory glassware apparatus for a variety of experimental techniques to include serial dilutions.
AT d	Use of light microscope at high power and low power, including use of a graticule.
AT e	Produce scientific drawing from observation with annotations.
AT f	Use qualitative reagents to identify biological molecules.
AT g	Separate biological compounds using thin layer/paper chromatography or electrophoresis.
AT h	Safely and ethically use organisms to measure: <ul style="list-style-type: none"> <li>• plant or animal responses</li> <li>• physiological functions.</li> </ul>
AT i	Use microbiological aseptic techniques, including the use of agar plates and broth.
AT j	Safely use instruments for dissection of an animal organ, or plant organ.
AT k	Use sampling techniques in fieldwork.
AT l	Use ICT such as computer modelling, or data logger to collect data, or use software to process data.

## Biology required activities (1-6 AS), (1-12 A-level)

Required activity	Apparatus and technique reference
1. Investigation into the effect of a named variable on the rate of an enzyme-controlled reaction	a, b, c, f, l
2. Preparation of stained squashes of cells from plant root tips; set-up and use of an optical microscope to identify the stages of mitosis in these stained squashes and calculation of a mitotic index	d, e, f
3. Production of a dilution series of a solute to produce a calibration curve with which to identify the water potential of plant tissue	c, h, j, l
4. Investigation into the effect of a named variable on the permeability of cell-surface membranes	a, b, c, j, l
5. Dissection of animal or plant gas exchange or mass transport system or of organ within such a system	e, h, j
6. Use of aseptic techniques to investigate the effect of antimicrobial substances on microbial growth	c, i
7. Use of chromatography to investigate the pigments isolated from leaves of different plants, eg leaves from shade-tolerant and shade-intolerant plants or leaves of different colours	b, c, g
8. Investigation into the effect of a named factor on the rate of dehydrogenase activity in extracts of chloroplasts	a, b, c
9. Investigation into the effect of a named variable on the rate of respiration of cultures of single-celled organisms	a, b, c, i
10. Investigation into the effect of an environmental variable on the movement of an animal using either a choice chamber or a maze	h
11. Production of a dilution series of a glucose solution and use of colorimetric techniques to produce a calibration curve with which to identify the concentration of glucose in an unknown 'urine' sample	b, c, f
12. Investigation into the effect of a named environmental factor on the distribution of a given species	a, b, h, k, l

## Tabulating data

It is important to keep a record of data while carrying out practical work. Tables should have clear headings with units indicated using a forward slash (solidus) before the unit. See example below.

Temperature/°C	Length/mm
10.0	53
20.0	25
30.0	12

Although using a forward slash is the standard format, other formats are generally acceptable. For example:

Volume in cm <sup>3</sup>	Time taken in s
15	23
25	45
35	56

Time (hours)	Number of cells
0	1
6	45
12	304

It is good practice to draw a table before an experiment commences and then enter data straight into the table on collection. This can sometimes lead to data points being in the wrong order. For example, when investigating the temperature at which an enzyme works best, a student may do a number of experiments at 25, 30, 35, 40 and 45°C, and then investigate the range between 30 and 40 further by adding readings at 31, 32, 33, 34, 36, 37, 38 and 39°C. Whilst this is perfectly acceptable, it is generally a good idea to make a fair copy of the table in ascending order of temperature to enable patterns to be spotted more easily. Reordered tables should follow the original data if using a lab book.

It is also expected that the independent variable is the left hand column in a table, with the following columns showing the dependent variables. These should be headed in similar ways to measured variables. The body of the table should not contain units.

### Tabulating logarithmic values

When the logarithm is taken of a physical quantity, the resulting value has no unit. However, it is important to be clear about which unit the quantity had to start with. The logarithm of a distance in km will be very different from the logarithm of the same distance in mm.

These should be included in tables in the following way:

Reading number	Time/s	Log (time/s)
1	2.3	0.36
2	3.5	0.54
3	5.6	0.75

## Significant figures

Data should be written in tables to the same number of significant figures. This number should be determined by the resolution of the device being used to measure the data or the uncertainty in measurement. For example, a sample labelled as “1 mol dm<sup>-3</sup> acid” should not be recorded in a table of results as 1.0 mol dm<sup>-3</sup> acid.

There is sometimes confusion over the number of significant figures when readings cross multiples of 10. Changing the number of decimal places across a power of ten retains the number of significant figures **but changes the accuracy**. The same number of decimal places should therefore generally be used, as illustrated below.

0.97	99.7
0.98	99.8
0.99	99.9
1.00	100.0
1.10	101.0

It is good practice to write down all digits showing on a digital meter.

Calculated quantities should be shown to the number of significant figures of the data with the least number of significant figures.

Example:

Calculate the size of an object if the magnification of a photo is  $\times 25$  and it is measured to be 24.6 mm on the photo.

$$\text{size of real object} = \frac{\text{size of image}}{\text{magnification}}$$

$$\text{size of real object} = \frac{24.6 \times 10^{-3}}{25}$$

$$\text{size of real object} = 9.8 \times 10^{-4}$$

Note that the size of the real object can only be quoted to two significant figures as the magnification is only quoted to two significant figures.

Equipment measuring to half a unit (eg a thermometer measuring to 0.5°C) should have measurements recorded to one decimal place (eg 1.0°C, 2.5°C). The uncertainty in these measurements would be  $\pm 0.25$ , but this would be rounded to the same number of decimal places (giving measurements quoted with uncertainty of  $(1.0 \pm 0.3)^\circ\text{C}$  etc).

# Uncertainties

## Sources of uncertainties

Students should know that every measurement has some inherent uncertainty.

The important question to ask is whether an experimenter can be confident that the true value lies in the range that is predicted by the uncertainty that is quoted. Good experimental design will attempt to reduce the uncertainty in the outcome of an experiment. The experimenter will design experiments and procedures that produce the least uncertainty and to provide a realistic uncertainty for the outcome.

In assessing uncertainty, there are a number of issues that have to be considered. These include:

- the resolution of the instrument used
- the manufacturer's tolerance on instruments
- the judgments that are made by the experimenter
- the procedures adopted (eg repeated readings)
- the size of increments available (eg the size of drops from a pipette).

Numerical questions will look at a number of these factors. Often, the resolution will be the guiding factor in assessing a numerical uncertainty. There may be further questions that require candidates to evaluate arrangements and procedures. Students could be asked how particular procedures would affect uncertainties and how they could be reduced by different apparatus design or procedure.

A combination of the above factors means that there can be no hard and fast rules about the actual uncertainty in a measurement. What we can assess from an instrument's resolution is the **minimum** possible uncertainty. Only the experimenter can assess the other factors, based on the arrangement and use of the apparatus. A rigorous experimenter would draw attention to these factors and take them into account.

## Readings and measurements

It is useful, when discussing uncertainties, to separate measurements into two forms:

- readings: the values found from a single judgement when using a piece of equipment.
- measurements: the values taken as the difference between the judgements of two values.

## Examples

When using a thermometer, a student only needs to make one judgement (the height of the liquid). This is a reading. It can be assumed that the zero value has been correctly set.

For stop watches and rulers, both the starting point and the end point of the measurement must be judged, leading to two uncertainties.

The following list is not exhaustive, and the way that the instrument is used will determine whether the student is taking a reading or a measurement.

Reading (one judgement only)	Measurement (two judgements required)
thermometer	Ruler
pH meter	Protractor
top pan balance	Stopwatch
measuring cylinder	analogue meter
volumetric flask	

The uncertainty in a **reading** when using a particular instrument is **no smaller** than plus or minus half of the smallest division or greater. For example, a temperature measured with a thermometer is likely to have an uncertainty of  $\pm 0.5^{\circ}\text{C}$  if the graduations are  $1^{\circ}\text{C}$  apart.

Students should be aware that readings are often written with the uncertainty. An example of this would be to write a voltage as  $(2.40 \pm 0.01) \text{ V}$ . It is usual for the uncertainty quoted to be the same number of decimal places as the value. Unless there are good reasons otherwise (eg an advanced statistical analysis), students at this level should quote the uncertainty in a measurement to the same number of decimal places as the value.

### Measurement example: length

When measuring length, **two** uncertainties must be included: the uncertainty of the placement of the zero of the ruler and the uncertainty of the point the measurement is taken from.

As both ends of the ruler have a  $\pm 0.5$  scale division uncertainty, the measurement will have an uncertainty of  $\pm 1$  division.

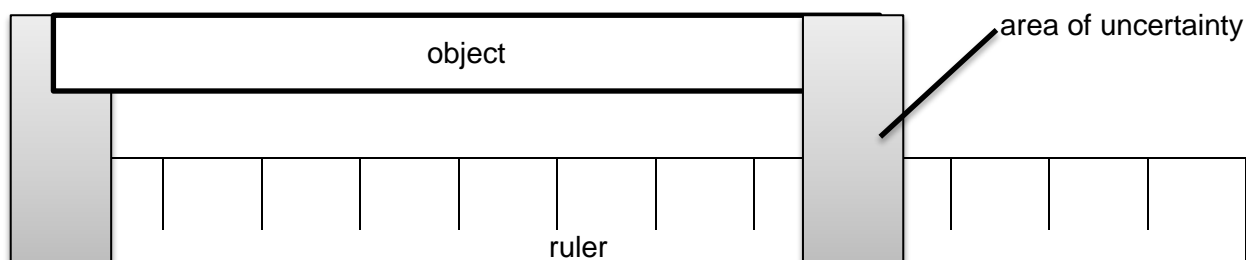

For most rulers, this will mean that the uncertainty in a measurement of length will be  $\pm 1 \text{ mm}$ .

This 'initial value uncertainty' will apply to any instrument where the user can set the zero (incorrectly), but would not apply to equipment such as balances or thermometers where the zero is set at the point of manufacture.

In summary

- The uncertainty of a reading (one judgement) is at least  $\pm 0.5$  of the smallest scale reading.
- The uncertainty of a measurement (two judgements) is at least  $\pm 1$  of the smallest scale reading.



The way measurements are taken can also affect the uncertainty.

### Measurement example: the extension of a spring

Measuring the extension of a spring using a metre ruler can be achieved in two ways.

1. Measuring the total length unloaded and then loaded.

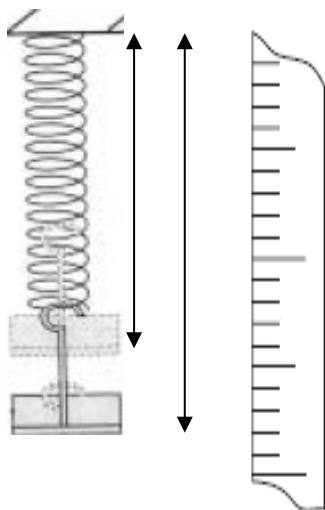

Four readings must be taken for this: the start and end point of the unloaded spring's length and the start and end point of the loaded spring's length.

The minimum uncertainty in each measured length is  $\pm 1$  mm using a meter ruler with 1 mm divisions (the actual uncertainty is likely to be larger due to parallax in this instance). The extension would be the difference between the two readings, so the minimum uncertainty would be  $\pm 2$  mm.

2. Fixing one end and taking a scale reading of the lower end.

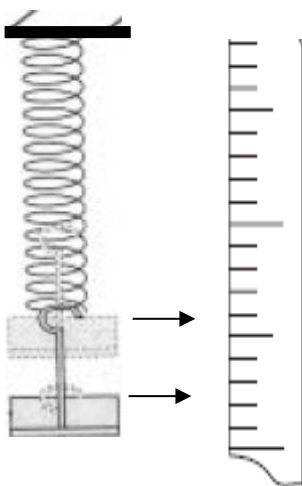

Two readings must be taken for this: the end point of the unloaded spring's length and the end point of the loaded spring's length. The start point is assumed to have zero uncertainty, as it is fixed.

The minimum uncertainty in each reading would be  $\pm 0.5$  mm, so the minimum extension uncertainty would be  $\pm 1$  mm.

Even with other practical uncertainties this second approach would be better.

Realistically, the uncertainty would be larger than this and an uncertainty in each reading of 1 mm or would be more sensible. This depends on factors such as how close the ruler can be mounted to the point as at which the reading is to be taken.

---

## Other factors

There are some occasions where the resolution of the instrument is not the limiting factor in the uncertainty in a measurement.

Best practice is to write down the full reading and then to write to fewer significant figures when the uncertainty has been estimated.

### Examples:

A stopwatch has a resolution of hundredths of a second, but the uncertainty in the measurement is more likely to be due to the reaction time of the experimenter. Here, the student should write the full reading on the stopwatch (eg 12.20 s), carry the significant figures through for all repeats, and reduce this to a more appropriate number of significant figures after an averaging process later.

If a student measures the length of a piece of wire, it is very difficult to hold the wire completely straight against the ruler. The uncertainty in the measurement is likely to be higher than the  $\pm 1$  mm uncertainty of the ruler. Depending on the number of “kinks” in the wire, the uncertainty could be reasonably judged to be nearer  $\pm 2$  or 3 mm.

## Uncertainties in given values

Often exam papers contain values. In all such cases assume the uncertainty to be  $\pm 1$  in the last significant digit. For example, if an exam stated “a person excreted 1660 mg of creatinine in 24 hours”, uncertainty would be assumed to be  $\pm 10$  mg of creatinine. The uncertainty may be lower than this but without knowing the details of the experiment and procedure that lead to this value there is no evidence to assume otherwise.

## Multiple instances of measurements

Some methods of measuring involve the use of multiple instances in order to reduce the uncertainty. For example, measuring the thickness of several leaves together, rather than just one leaf. The uncertainty of each measurement will be the uncertainty of the whole measurement divided by the number of leaves. This method works because the percentage uncertainty of the thickness of a single leaf is the same as the percentage uncertainty for the thickness of multiple leaves.

### Example:

Thickness of 10 leaves:  $(3.10 \pm 0.1)$  mm

Mean thickness of one leaf:  $(0.31 \pm 0.01)$  mm

## Repeated measurements

Repeating a measurement is a method for reducing the uncertainty.

With many readings it's possible to also identify those that are exceptional (that are far away from a significant number of other measurements). Sometimes it will be appropriate to remove outliers from measurements before calculating a mean. On other occasions, particularly in Biology, outliers are important to include. For example, it is important to know that a particular drug produces side effects in one person in a thousand.

If measurements are repeated, the uncertainty can be calculated by finding half the range of the measured values.

**For example:**

<b>Repeat</b>	1	2	3	4
<b>Distance/m</b>	1.23	1.32	1.27	1.22

$1.32 - 1.22 = 0.10$  therefore

Mean distance:  $(1.26 \pm 0.05)$  m

### Percentage uncertainties

The percentage uncertainty in a measurement can be calculated using:

$$\text{percentage uncertainty} = \frac{\text{uncertainty}}{\text{value}} \times 100\%$$

The percentage uncertainty in a repeated measurement can also be calculated using:

$$\text{percentage uncertainty} = \frac{\text{uncertainty}}{\text{mean value}} \times 100\%$$

### Uncertainties in exams

Wherever possible, questions in exams will be clear on whether students are being asked to calculate the uncertainty of a reading, a measurement, or given data.

Where there is ambiguity, mark schemes will allow alternative sensible answers and credit clear thinking.

It is important that teachers read the reports on the exam following each series to understand common mistakes to help their students improve in subsequent years.

### Uncertainties in practical work

Students are expected to develop an understanding of uncertainties in measurements through their practical work. Teachers may use students' assessments of uncertainties in measurements, and their recording, as evidence towards several of the endorsement criteria. Teachers will decide on each occasion what acceptable uncertainty values are, and the ways in which they expect students to record these.

### Examples:

CPAC 2: Students should be attempting to reduce the uncertainties in experiments. This could be by choosing appropriate equipment (CPAC 2d), or by choosing procedures such as repeating readings that reduce overall uncertainties (CPAC 2c).

CPAC 4: Students' records should take into account uncertainties. For example, students should be making sensible decisions about the number of significant figures to include, particularly in calculated values.

CPAC 5: Students could comment on the uncertainties in their measurements. For example, students could comment on whether the true value (eg for a concentration, or the acceleration due to gravity) lies within their calculated range of uncertainty. With some measurements, students may compare their value with those from secondary sources, contributing evidence for CPAC 5b.

## Combining uncertainties

Percentage uncertainties should be combined using the following rules:

Combination	Operation	Example
Adding or subtracting values $a = b + c$	Add the absolute uncertainties $\Delta a = \Delta b + \Delta c$	Length of leaf on day 1 = $(5.0 \pm 0.1)$ cm Length of leaf on day 2 = $(7.2 \pm 0.1)$ cm Difference in length = $(2.2 \pm 0.2)$ cm
Multiplying values $a = b \times c$	Add the percentage uncertainties $\epsilon a = \epsilon b + \epsilon c$	Voltage = $(15.20 \pm 0.1)$ V Current = $(0.51 \pm 0.01)$ A Percentage uncertainty in voltage = 0.7% Percentage uncertainty in current = 1.96% Power = Voltage $\times$ current = 7.75 W Percentage uncertainty in power = 2.66% Absolute uncertainty in power = $\pm 0.21$ W
Dividing values $a = \frac{b}{c}$	Add the percentage uncertainties $\epsilon a = \epsilon b + \epsilon c$	Mass of salt solution = $(100 \pm 0.1)$ g Mass of salt = $(20.0 \pm 0.5)$ g Percentage uncertainty in mass of solution = 0.1% Percentage uncertainty in mass of salt = 2.5% Percent composition by mass = $\frac{\text{mass of salt}}{\text{mass of solution}} \times 100\% = 20\%$ Percentage uncertainty of percentage = 2.6% Absolute uncertainty = $\pm 0.5\%$
Power rules $a = b^c$	Multiply the percentage uncertainty by the power $\epsilon a = c \times \epsilon b$	Radius of circle = $(6.0 \pm 0.1)$ cm Percentage uncertainty in radius = 1.6% Area of circle = $\pi r^2 = 113.1$ cm <sup>2</sup> Percentage uncertainty in area = 3.2% Absolute uncertainty = $\pm 3.6$ cm <sup>2</sup> (Note – the uncertainty in $\pi$ is taken to be zero)

Note: Absolute uncertainties (denoted by  $\Delta$ ) have the same units as the quantity.

Percentage uncertainties (denoted by  $\epsilon$ ) have no units.

Uncertainties in trigonometric and logarithmic functions will not be tested in A-level exams.

## Graphing

Graphing skills can be assessed both in written papers for the A-level grade and by the teacher during the assessment of the endorsement. Students should recognise that the type of graph that they draw should be based on an understanding of the type of data they are using and the intended analysis of it. The rules below are guidelines which will vary according to the specific circumstances.

Please note: The Royal Society of Biology suggests that even straight lines on graphs should be referred to as 'curve'. This convention is **not** used in the following pages to ensure clarity.

### Labelling axes

Axes should always be labelled with the variable being measured and the units. These should be separated with a forward slash (solidus):

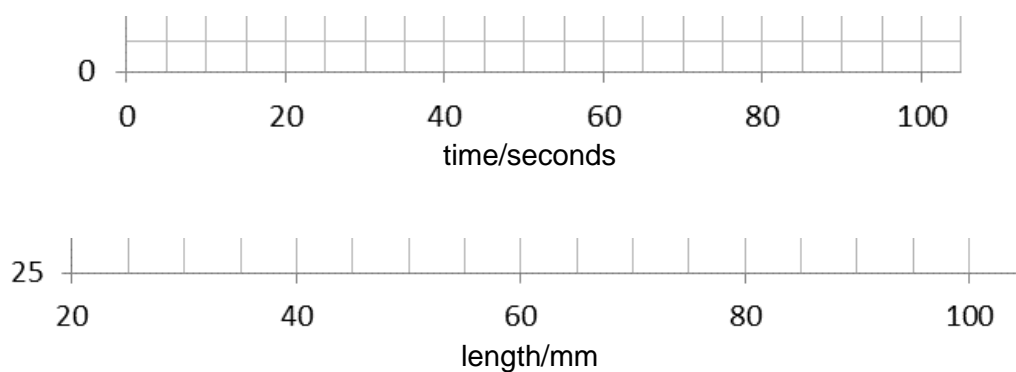

Axes should not be labelled with the units on each scale marking.

### Data points

Data points should be marked with a cross. Both  $\times$  and  $+$  marks are acceptable, but care should be taken that data points can be seen against the grid.

Error bars, standard deviation and ranges can take the place of data points where appropriate.

## Scales and origins

Students should attempt to spread the data points on a graph as far as possible without resorting to scales that are difficult to deal with. Students should consider:

- the maximum and minimum values of each variable
- the size of the graph paper
- whether 0.0 should be included as a data point
- how to draw the axes without using difficult scale markings (eg multiples of 3, 7, 11 etc)
- in exams, the plots should cover **at least half** of the grid supplied for the graph.

Please note that in the Uncertainties and Graphing sections, many generic graphs are used to illustrate the points made. For example, the following three graphs are intended to illustrate the information above relating to the spread of data points on a graph. Students producing such graphs on the basis of real practical work or in exam questions would be expected to add in axes labels and units.

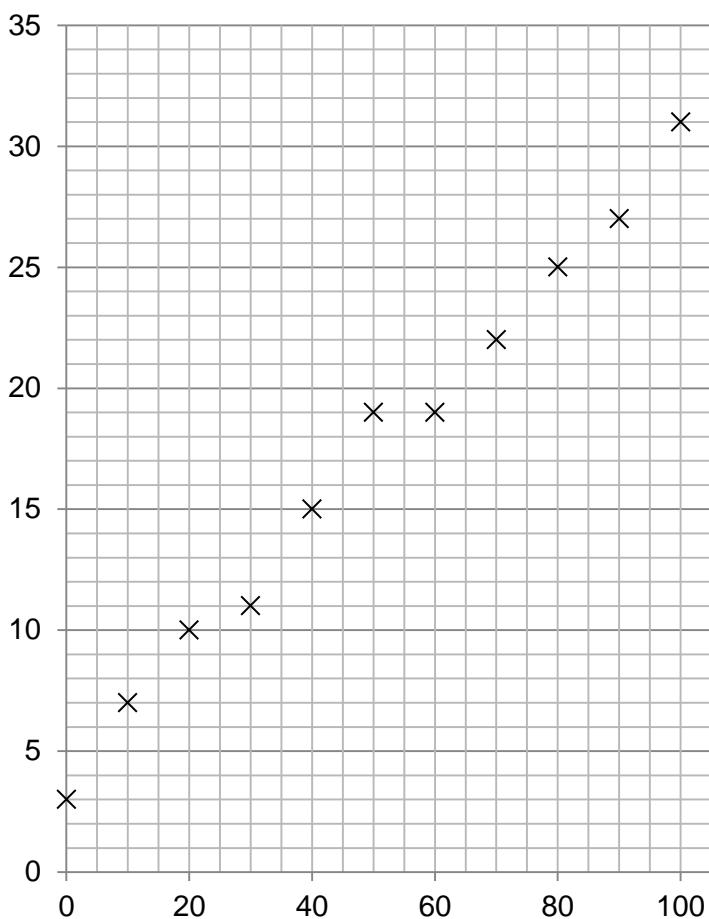

This graph has well-spaced marking points and the data fills the paper.

Each point is marked with a cross (so points can be seen even when a line of best fit is drawn).

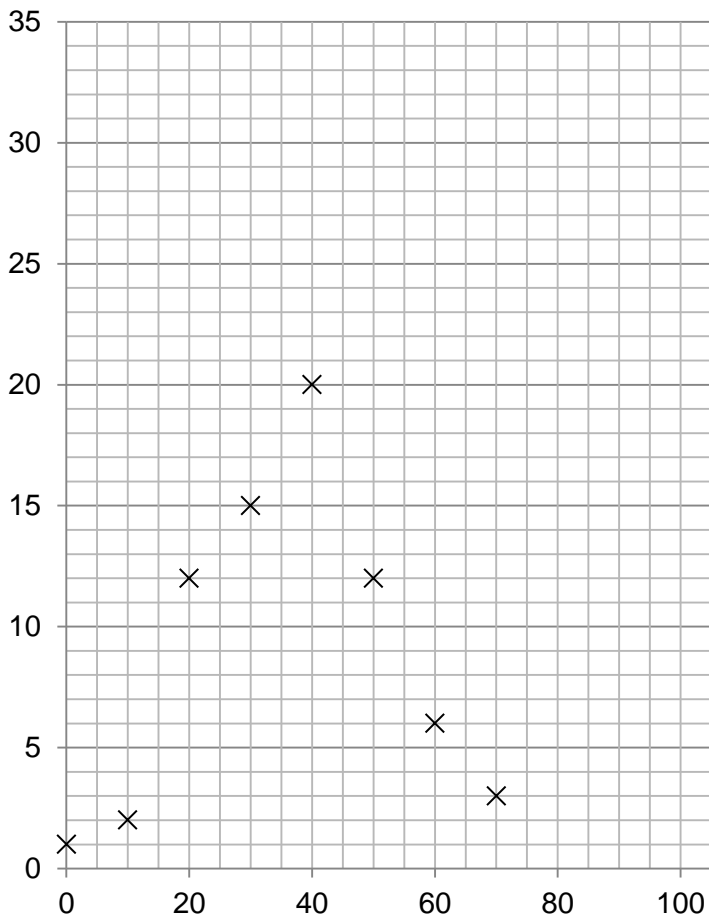

This graph is on the limit of acceptability. The points do not quite fill the page, but spreading them further would result in the use of awkward scales.

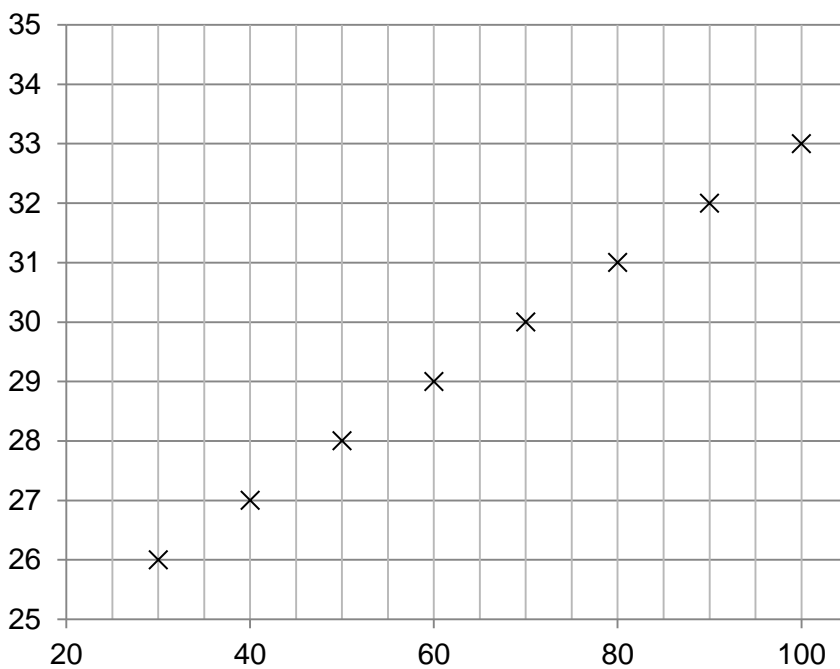

At first glance, this graph is well drawn and has spread the data out sensibly. However, if the graph were to later be used to calculate the equation of the line, the lack of a y-intercept could cause problems. Increasing the axes to ensure all points are spread out but still including the y-intercept is a skill that requires practice and may take a couple of attempts.

---

## Lines of best fit

Lines of best fit should be drawn when appropriate. Students should consider the following when deciding where to draw a line of best fit:

- are the data likely to be following an underlying equation (for example, a relationship governed by a physical law)? This will help decide if the line should be straight or curved
- are there any anomalous results?
- are there uncertainties in the measurements? The line of best fit should fall within error bars, if drawn.

There is no definitive way of determining where a line of best fit should be drawn. A good rule of thumb is to make sure that there are as many points on one side of the line as the other. Often the line should pass through, or very close to, the majority of plotted points. Graphing programs can sometimes help, but tend to use algorithms that make assumptions about the data that may not be appropriate.

Lines of best fit should be continuous and drawn as a thin pencil that does not obscure the points below and does not add uncertainty to the measurement of gradient of the line.

Not all lines of best fit go through the origin. Students should ask themselves whether a 0 in the independent variable is likely to produce a 0 in the dependent variable. This can provide an extra and more certain point through which a line must pass. A line of best fit that is expected to pass through (0,0), but does not, would imply some systematic error in the experiment. This would be a good source of discussion in an evaluation.

## Dealing with anomalous results

At GCSE, students are often taught automatically to ignore anomalous results. At A-level, students should think carefully about what could have caused the unexpected result and therefore whether it is anomalous. A student might be able to identify a reason for the unexpected result and so validly regard it as an anomaly. For example, an anomalous result might be explained by a different experimenter making the measurement, a different solution or a different measuring device being used. In the case where the reason for an anomalous result occurring can be identified, the result should be recorded and plotted but may then be ignored. Biology students must be careful in deciding results are anomalous and should always bear in mind that diversity is a feature of biological material.

Anomalous results should also be ignored where results are expected to be the same (for example, when repeat readings of pH are taken of the same sample).

Where there is no obvious error and no expectation that results should be the same, anomalous results should be included. This will reduce the possibility that a key point is being overlooked.

Please note: when recording results it is important that all data are included. Anomalous results should only be ignored at the data analysis stage.

It is best practice whenever an anomalous result is identified for the experiment to be repeated. This highlights the need to tabulate and even graph results as an experiment is carried out.



## Scatter graphs

Often in Biology we find a relationship between two continuous variables but cannot infer that the relationship is causal. For example, in the UK, is there a relationship between the number of worms and the number of woodlice? We could plot values for these two continuous variables as a graph but it would not be valid to join the plotted points. We use a scatter graph to investigate correlations. A line of best fit indicates a positive, negative, or absent correlation.



## Jagged-line graphs

In Biology, the Royal Society of Biology recommends that where the interim values of a continuously changing variable are not known, data points should be joined by straight lines.

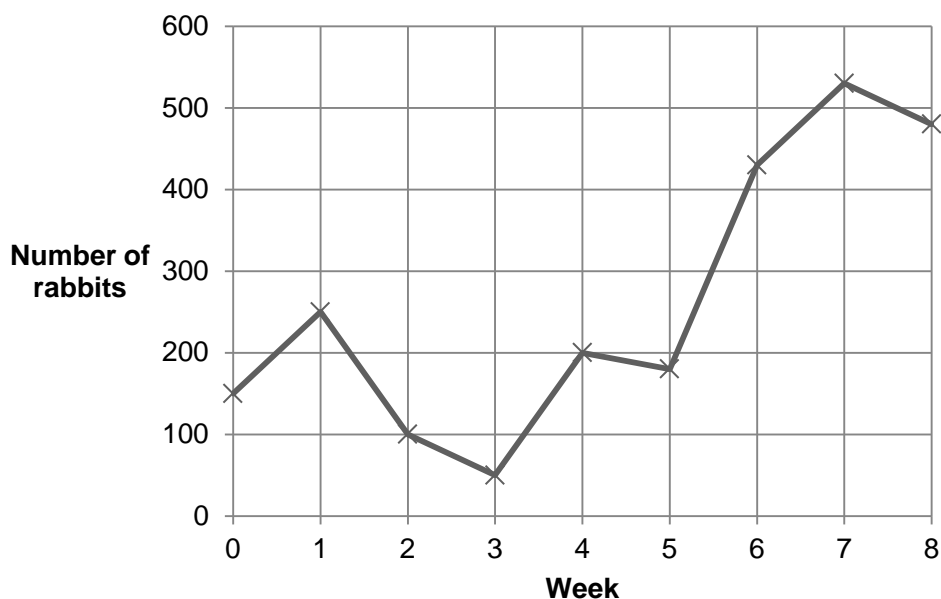

## Histograms

As with a line graph and scatter graph, a histogram is used to show the distribution of a continuous variable. In this case, the data for the dependent variable are arranged into non-overlapping groups. These groups could cover an equal span of data, eg, 0.0 to 4.9, 5.0 to 9.9, 10.0 to 14.9, or an unequal span of data, eg 0 to 0.9, 1 to 3.9, 4 to 7.9, 8 to 8.9.

These groups are arranged on the x-axis with widths scaled to represent each span of data. When the dependent variable is plotted, the area under each rectangle is equal to the frequency of the observations in that interval.

In a histogram, the bars touch.

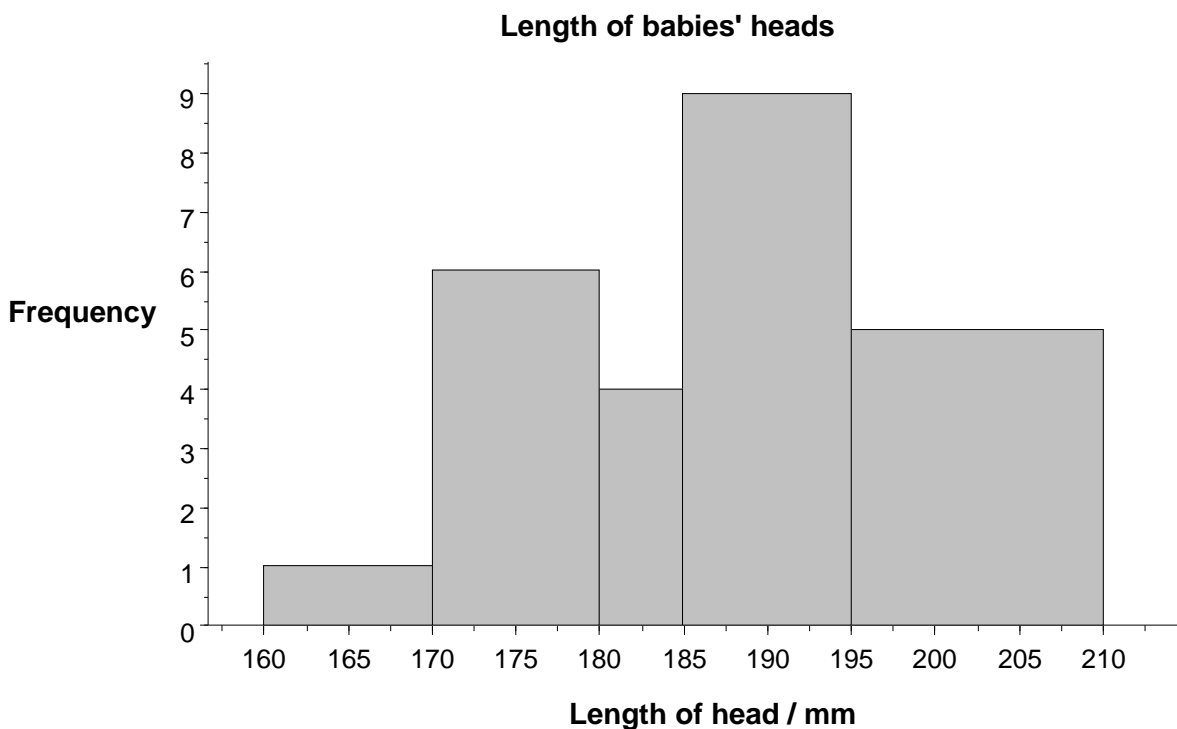

## Bar charts

Line graphs and histograms are used when the data are continuous. In contrast, bar charts are used when the data are discontinuous because they are:

- **categoric** – only certain values can exist (eg reading at week 1, reading at week 2 etc)
- **nominal** – there is no ordering of the categories (eg red flowers, pink flowers and white flowers of *Antirrhinum*).

Since these data are not continuous, the intervals on the x-axis should show this and, unlike a histogram, the rectangles must **not** touch.

Unlike histograms, the bars of a bar chart should be of equal width (including a single straight line), so that the height of the bar represents the frequency of each category.

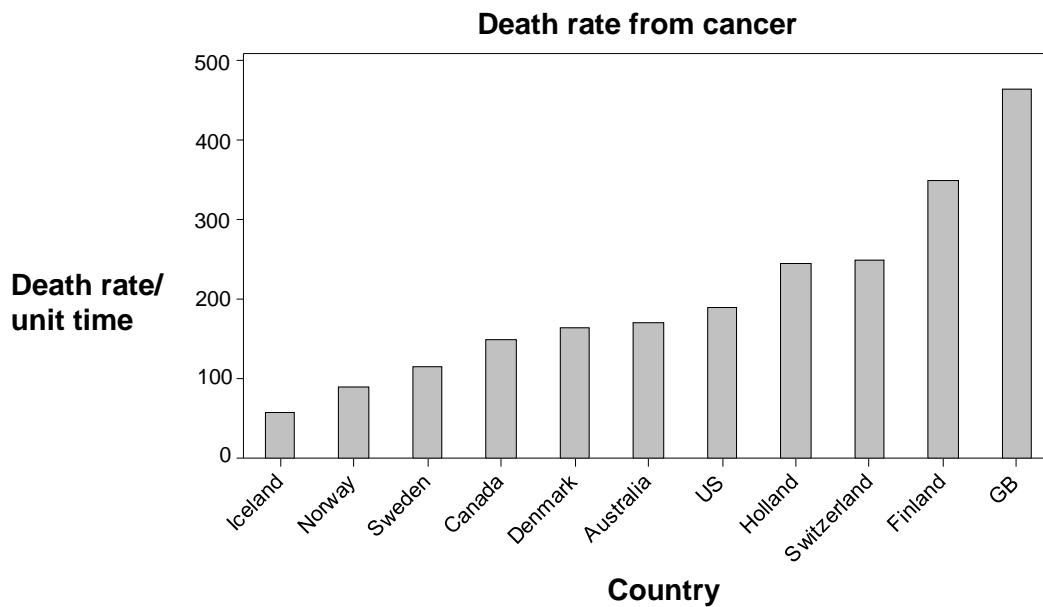

## Measuring gradients

When finding the gradient of a line of best fit, students should show their working by drawing a triangle on the line. The hypotenuse of the triangle should be at least half as big as the line of best fit.

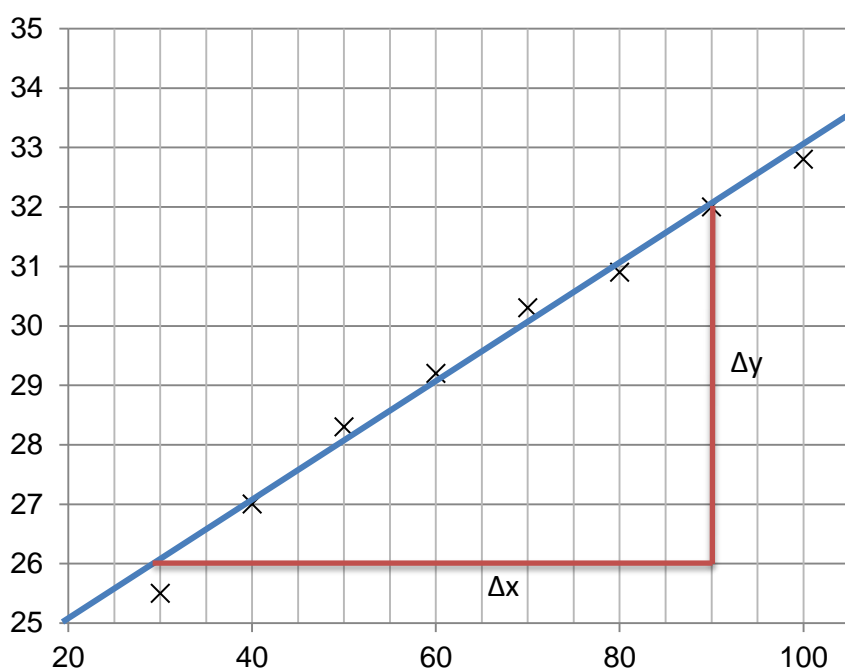

The line of best fit here has an equal number of points on both sides. It is not too wide so points can be seen under it.

The gradient triangle has been drawn so the hypotenuse includes more than half of the line.

In addition, it starts and ends on points where the line of best fit crosses grid lines so the points can be read easily (this is not always possible).

$$\text{gradient} = \frac{\Delta y}{\Delta x}$$

When finding the gradient of a curve, eg the rate of reaction at a time that was not sampled, students should draw a tangent to the curve at the relevant value of the independent variable (x-axis).

Use of a set square to draw a triangle over this point on the curve can be helpful in drawing an appropriate tangent.

## The equation of a straight line

Students should be able to translate graphical data into the equation of a straight line.

$$y = mx + c$$

Where  $y$  is the dependent variable,  $m$  is the gradient,  $x$  is the independent variable and  $c$  is the  $y$ -intercept.

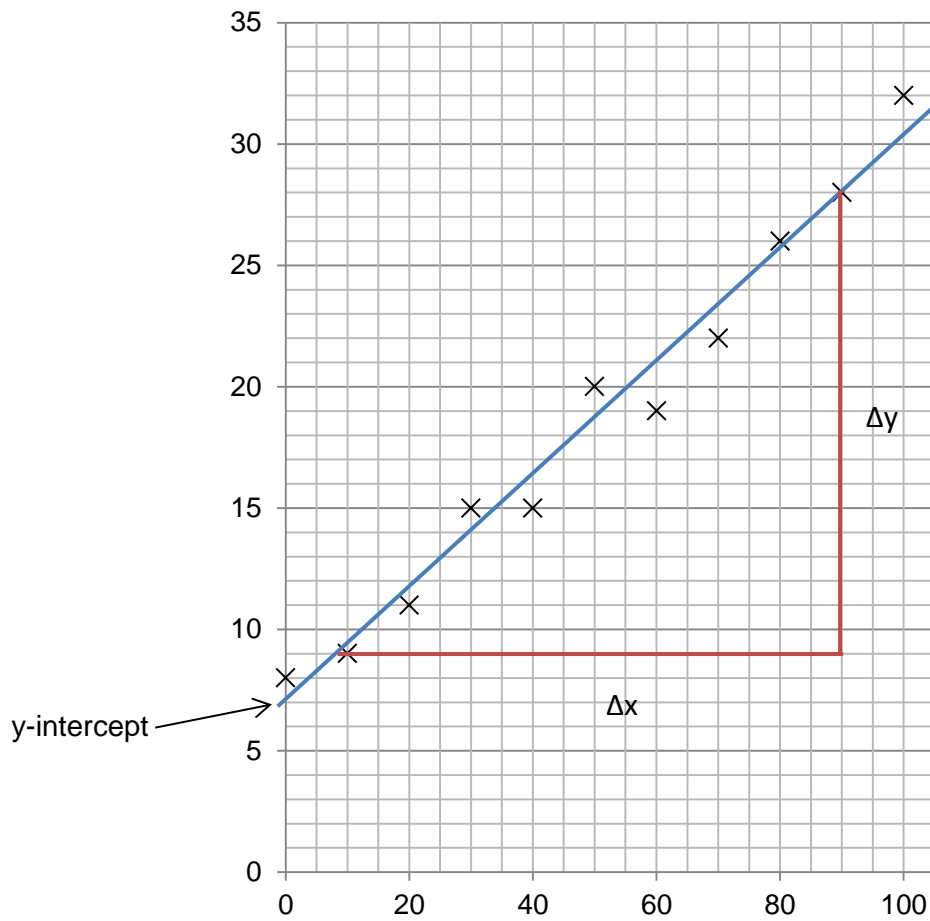

## Biological drawing

The purpose of drawing in the teaching of Biology is the development of observational skills. A student must look very closely at a specimen in order to draw it accurately and must have sound knowledge of the component structures in order to choose what to draw and what to omit from the drawing.

Drawings should always be in pencil. Fine detail cannot be represented accurately unless the pencil has a sharp point.

The outlines of any structures should be drawn but there should be no colouring or shading. The relative sizes of the structures drawn should be accurate. Construction lines or frames could be used to solve this problem. If the relative size of any structure has been exaggerated, eg because an actual cell wall was too thin to be able to draw its outline using two pencil lines, a note should be added to the drawing to explain this.

If required, the drawn structures should be labelled, using label lines that do not cross or obscure the drawing, with brief annotations about their functions or interrelationships.

The drawing should have an explanatory title and an indication of the real size of the structures drawn or of the magnification used.

During an AS or A-level Biology course, students are likely to make three types of drawing. These three are:

### Cell drawing

The purpose of this drawing is to show accurately the components of individual cells observed using an optical microscope. The drawing should be detailed but should **not** show more than two or three cells.

### Tissue map













The purpose of a tissue map is to show the location and extent of tissues in an organ or in a whole organism. Cellular detail of any of the tissues should **not** be shown. Instead, the outline of each tissue should be drawn. This often presents a problem, since cell differentiation is seldom discrete. Students must use their background knowledge and understanding to interpret what they see.

### Body plan

Following dissection, a morphological drawing should provide a lifelike representation of the main body parts exposed by the dissection. A small part drawn well is much better than a full drawing drawn badly.

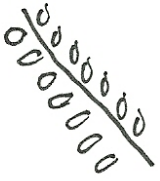
## Common errors in biological drawing

The table below shows errors that commonly occur when students begin to practise drawings of biological material. Each would reduce the value of the drawing and result in loss of credit being awarded. Most result from lack of attention or care and are easily solved.

Comment	Incorrect	Correct
Cell outline		
Tissue with too much detail		
Crossing lines		
Hanging lines		
Over casual		
Sketch rather than draw		

## Statistical tests in Biology

During development of the new specification, there was general agreement amongst examiners, teachers and representatives from higher education and industry that there is no value in students calculating test statistics manually as computers are used to carry out calculations in most commercial and academic institutions. Consequently, we expect that wherever possible most students will be encouraged to use electronic devices to calculate test statistics during their classwork.

In written exams, students might be asked to perform simple calculations such as finding a mean value. In written exams, students will **not** be asked to perform a calculation using a statistical test. Instead, it is important for students to understand how to select a statistical test that is appropriate for given data and to be able interpret the results of such a statistical test. Students could also be asked in a written exam to explain their choices and interpretation. They should also be able to interpret the probability value calculated from such a statistical test in terms of accepting or rejecting a null hypothesis.

Students taking A-level Biology should be familiar with the language of statistics and understand the need to devise random sampling procedures that avoid observer bias.

Students will be expected to be familiar with the following types of statistics.

- **Descriptive statistics** that provide an understanding of the data.
- **Inferential statistics** that enable inferences about a population based on the sample of data that has been collected.

Teachers should decide the best method of teaching students the use of statistical tests. In some circumstances, the full numerical analysis may be appropriate so that students understand the information needed for a particular test. In other circumstances, using computers to carry out the analysis followed by discussion of the findings will be sufficient.

### Descriptive statistics

At A-level, we usually assume that populations and samples show a normal distribution. This enables students to use a **mean** and **standard deviation of the mean** to describe data.

Students could calculate mean values and their standard deviations during class work but will **not** be asked to calculate a standard deviation in a written examination. They should appreciate the advantage of using standard deviation in preference to the range of values, the latter being overly influenced by outlying values.

When calculating the mean value from a **sample**, the mean is represented as  $\bar{x}$  (pronounced x-bar). It is the sum of all the values, divided by the number of values, ie:

$$\bar{x} = \frac{\Sigma x}{n}$$



---

The standard deviation (SD) gives an indication of the spread of values around the mean of those values. It is found using the below formula.

$$SD = \sqrt{\frac{\Sigma(x - \bar{x})^2}{n - 1}}$$

In interpreting the values of standard deviations, students should realise that  $\pm 2$  standard deviations from the mean includes over 95% of the data. Whilst not strictly valid, this allows students to use the presence or absence of overlap of the standard deviations of different means as an indication of whether differences in the means are likely to be due to chance.

In addition to the mean, students should be confident in identifying and using the **median** and **mode** values of data.

95% Confidence intervals (95% CI): since students will calculate a standard deviation, teachers could introduce them to the **standard error of the mean** (SE), though this is **not** a specification requirement. This gives an indication of how close the mean of a sample might be to the mean of the population from which the sample was taken or to the mean of another sample from the same population. It is calculated by dividing the standard deviation of the mean by the square root of the sample size, ie:

$$SE = \frac{SD}{\sqrt{n}}$$

Since the true population mean  $\pm 1.96$  SE will include 95% of the sample means, the standard error enables students to use 95% confidence intervals.

To calculate the 95% confidence interval, we multiply the standard error of each mean by 1.96. Subtracting this value from the mean gives the lower 95% confidence limit and adding it to the sample mean gives the upper 95% confidence limit.

$$95\% CI = \bar{x} \pm SE \times 1.96$$

We can use the 95% confidence interval to state that:

- we are 95% confident that the true mean value of the population from which the sample was taken lies between the upper and lower confidence limits
- if the intervals of two calculated means do not overlap, we are 95% confident that these means are different.

## Statistical tests

Students should be aware that statistical tests are used to test a theory, known as a hypothesis. Perhaps, counter-intuitively, the hypothesis is usually that there is **no** difference between the samples being studied, ie is a **null hypothesis**. The table shows how hypotheses can be turned into null hypotheses.

Hypothesis	Null hypothesis
Chickens fed maize supplemented by lipid produce more male offspring than those fed maize alone.	There is no difference between the number of male and female offspring of chickens fed maize supplemented by lipid and those fed maize alone.
There are fewer slugs in dry areas.	There is no difference between the number of slugs found in wet and dry areas.
Tobacco plants exhibit a higher rate of growth when planted in soil rather than peat.	Tobacco plants do not exhibit a higher rate of growth when planted in soil rather than peat.
The incidence of sunburn is associated with the sale of ice cream.	There is no association between the incidence of sunburn and the sale of ice cream.

Once we have a null hypothesis, we design an experiment to try to disprove it. Thus, the result of a statistical test either disproves or fails to disprove (supports or fails to support) that null hypothesis; it can never prove a hypothesis to be true.

## Significance levels

Given the results of an experiment, we need to know if any difference between the results we predicted from our null hypothesis and those we obtained could be due to chance. If this difference is likely to be due to chance, it is said to be 'non-significant' and the null hypothesis cannot be rejected. On the other hand, if this difference is not likely to be due to chance, it is said to be significant and the null hypothesis can be rejected.

Each statistical test is associated with a table which enables us to calculate a significance level.

For convenience, students can assume that if the probability (P) of the difference in their results being due to chance is equal to, or less than, 1 in 20 ( $P \leq 0.05$ ), the difference **is significant**.

Note that students should **not** refer to their **results** being due to chance (or to their results being significant/insignificant). They should always refer to the differences or associations in their results being due to chance (or differences or associations in their results being significant/insignificant).

## Choice of statistical test

No single statistical test is suitable for all data. The mathematical requirements of this Biology specification include three statistical tests: the chi-squared ( $\chi^2$ ) test, the student's *t*-test and a correlation coefficient. Although students should use data from their practical work to perform calculations using these tests, they will **not** be asked to do so in a written exam. They can, however, be asked to:

- choose which test would be appropriate for given data
- justify their choice of statistical test
- interpret a given probability value in terms of accepting or rejecting a null hypothesis.

The following decision-making flowchart can be used to decide which of the three tests is appropriate for given data. This flowchart will **not** be provided in written examinations.

### Flowchart for deciding which statistical test to use

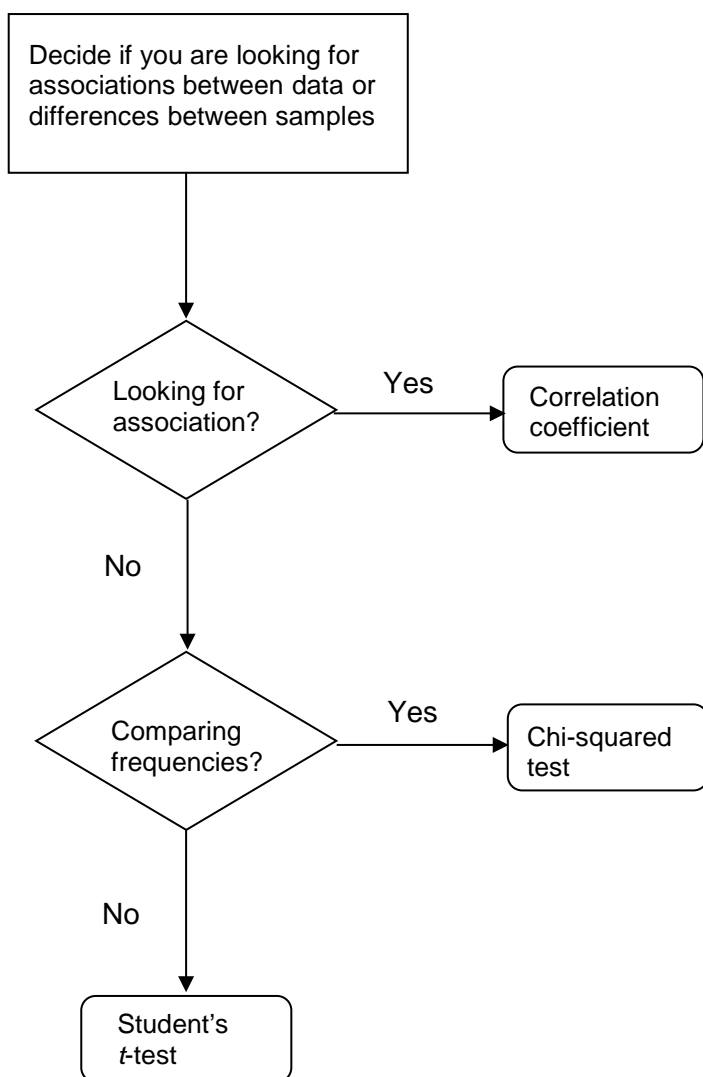

## Further guidance on teaching statistics in Biology

The Department for Education criteria for A-level Biology (GCE AS and A-level subject content for Biology, Chemistry, Physics and Psychology) include the following mathematical skills that are relevant to statistics.

Code	Mathematical skill	Exemplification of mathematical skill in the context of biology
MS 1.9	Select and use a statistical test	Students may be tested on their ability to select and use: <ul style="list-style-type: none"><li>the chi-squared test to test the significance of the difference between observed and expected results</li><li>the student's <i>t</i>-test</li><li>the correlation coefficient.</li></ul>
MS 1.10	Understand measures of dispersion, including standard deviation and range	Students may be tested on their ability to: <ul style="list-style-type: none"><li>calculate the standard deviation</li><li>understand why standard deviation might be a more useful measure of dispersion for a given set of data, eg where there is an outlying result.</li></ul>

The description of these skills has been included verbatim in our specification for AS and A-level Biology. Since these statements are not in bold type, they could all potentially be examined in both AS and A-level papers.

In teaching the AQA Biology AS and A-level specifications, we recommend that 'the correlation coefficient' with which students become familiar is **Spearman's rank**, as in the legacy specification. Ultimately, though, the choice is left to the teacher. Consequently, if a question in a written test requires students to recognise that a correlation coefficient is the appropriate statistical test to use with given data, the answers 'Spearman's rank', 'correlation coefficient' or any named correlation coefficient will be credited.

In written exams, students might be asked to perform simple calculations such as finding a mean value. **Students will not be asked to perform a calculation using a statistical test** (or to calculate the standard deviation of a mean). This policy reflects the recognition by examiners and teachers that the tariff in the legacy ISA and EMPA does not reflect the time spent in performing such calculations. We would expect students to perform such calculations during their class work, however. While teachers might feel there is value in students performing these calculations manually, the use of devices reflects the general agreement in higher education and industry that there is little value in students calculating test statistics manually when computers are used in most commercial and academic institutions. In line with this, we won't test student ability to use tables of critical values for the three specified statistical tests in exams.

In preparing for written exams, it will be important for students to understand how to select a statistical test appropriate for given data and interpret the results of such a statistical test, in terms of rejection of the null hypothesis if  $P \leq 0.05$ . Students could also be asked to justify their choices and interpretation.

Although the subject criteria do not differentiate between AS and A-level, AQA papers will expect progression in the understanding of statistical tests in AS and A-level exams.

Traditionally, statistics have been taught as part of the second year of the course. We are confident that the inclusion of statistics in first year (co-teachable AS) can be managed within the class time and that sound understanding by students can be achieved with very little effect on teaching time.

In AS exams, students could be expected to:	In A-level exams, students could also be expected to:
<p><b>formulate</b> a null hypothesis</p> <ul style="list-style-type: none"> <li>• for the experiments they perform during their class work</li> <li>• when given appropriate information, for experiments carried out by others</li> </ul>	<p><b>evaluate</b> the null hypothesis of another investigator</p>
<p><b>devise</b> and <b>justify</b> an appropriate table in which to record their raw data</p>	
<p><b>devise</b> and <b>justify</b> an appropriate way to represent their processed data graphically</p>	<p><b>evaluate</b> the way in which another investigator has represented processed data</p>
<p><b>select</b>, and <b>justify</b> the selection of, an appropriate statistical test for data they will subsequently collect themselves or data that might be collected by others. The statistical tests are restricted to:</p> <ul style="list-style-type: none"> <li>• <b>chi-squared test</b> when the data are categoric</li> <li>• the <b>student's t test</b> when comparing the mean values of two sets of data</li> <li>• a <b>correlation coefficient</b> when examining an association between two sets of data</li> </ul>	<p><b>evaluate</b> the choice of a statistical test made by another investigator</p>
<p><b>interpret</b> a given probability value in terms of the probability of the difference between observed data and expected data (chi-squared test), the difference between the means of two samples (student's <i>t</i>-test) or a correlation between two variables (correlation coefficient) being due to chance.</p>	<p><b>interpret</b> a given probability value in terms of acceptance or rejection of a null hypothesis, using 0.05 as the critical probability value</p> <p><b>evaluate</b> the conclusions from the same data made by another commentator</p> <p><b>show an understanding</b> of 'degrees of freedom' so that, when given appropriate information, a student can use a given result of a statistical test to find the correct probability value from an abridged table of values.</p>

## Teaching statistics at AS

There are many opportunities for students to be introduced to statistical concepts during their AS course. The start of every investigative practical presents an opportunity for students to:

- formulate a null hypothesis that is appropriate for the investigation they will perform, eg 'temperature (the independent variable) has no effect on the rate of an enzyme-catalysed reaction (the dependent variable)'
- devise an appropriate way to tabulate the raw data they will collect
- devise an appropriate way to represent their processed data graphically.

The following examples show how the choice and justification of appropriate statistical tests could be included in class work during an AS Biology course. Students could also be encouraged to calculate and interpret the result of their chosen statistical test. These are intended only as a guide to areas in which the statistical tests could be used and are **not** specification requirements.

Section	Opportunities for skills development
3.1.4.2 <b>Required practical 1</b>	Students could select and use an appropriate statistical test to find the significance of differences in the rates of reaction following use of a continuous variable (eg pH, temperature, enzyme concentration or substrate concentration) or of a discontinuous variable (eg presence and absence of an enzyme inhibitor).
3.2.1.1	Students could select and use an appropriate statistical test to find the significance of different mean numbers of a particular organelle (eg mitochondria or chloroplasts) in different types of cells.
3.2.2 <b>Required practical 2</b>	Students could select and use an appropriate statistical test to find the significance of differences in the number of cells undergoing mitosis at two close, but different, distances from the root tip.
3.3.2	Students could select and use an appropriate statistical test to find the significance of differences in the number of stomata on the upper and lower surfaces of leaves of a single plant species or on the lower surfaces of leaves of different plant species.
3.3.2	Students could select and use an appropriate statistical test to find the significance of a correlation between data about an environmental variable and data about the incidence of a particular lung disease.
3.3.4.1	Students could select and use an appropriate statistical test to find the significance of a correlation between data about an environmental variable and data about the incidence of a particular cardiovascular disease.
3.3.4 <b>Required practical 6</b>	Students could select and use an appropriate statistical test to find the significance of differences in the effect of different antibiotics on the growth of a species of bacterium or of a single antibiotic on the growth of more than one species of bacterium.
3.4.7	Students could select and use an appropriate statistical test to find the significance of differences in the mean values they have collected or been given.

## Subject specific vocabulary

### The language of measurement

The following subject specific vocabulary provides definitions of key terms used in our AS and A-level science specifications. This information is accurate at the time of publication, but see our website for the most up to date [subject specific vocabulary](#).

#### **Accuracy**

A measurement result is considered accurate if it is judged to be close to the true value.

#### **Calibration**

Marking a scale on a measuring instrument.

This involves establishing the relationship between indications of a measuring instrument and standard or reference quantity values, which must be applied.

For example, placing a thermometer in melting ice to see whether it reads 0°C, in order to check if it has been calibrated correctly.

#### **Data**

Information, either qualitative or quantitative, that has been collected.

#### **Errors**

See also uncertainties.

#### **Measurement error**

The difference between a measured value and the true value.

#### **Anomalies**

These are values in a set of results which are judged not to be part of the variation caused by random uncertainty.

#### **Random error**

These cause readings to be spread about the true value, due to results varying in an unpredictable way from one measurement to the next.

Random errors are present when any measurement is made, and cannot be corrected. The effect of random errors can be reduced by making more measurements and calculating a new mean.

#### **Systematic error**

These cause readings to differ from the true value by a consistent amount each time a measurement is made.

Sources of systematic error can include the environment, methods of observation or instruments used.

Systematic errors cannot be dealt with by simple repeats. If a systematic error is suspected, the data collection should be repeated using a different technique or a different set of

---

equipment, and the results compared.

**Zero error**

Any indication that a measuring system gives a false reading when the true value of a measured quantity is zero, eg the needle on an ammeter failing to return to zero when no current flows. A zero error may result in a systematic uncertainty.

**Evidence**

Data which has been shown to be valid.

**Fair test**

A fair test is one in which only the independent variable has been allowed to affect the dependent variable.

**Hypothesis**

A proposal intended to explain certain facts or observations.

**Interval**

The quantity between readings, eg a set of 11 readings equally spaced over a distance of 1 metre would give an interval of 10 centimetres.

**Precision**

Precise measurements are ones in which there is very little spread about the mean value.

Precision depends only on the extent of random errors – it gives no indication of how close results are to the true value.

**Prediction**

A prediction is a statement suggesting what will happen in the future, based on observation, experience or a hypothesis.

**Range**

The maximum and minimum values of the independent or dependent variables; important in ensuring that any pattern is detected.

For example a range of distances may be quoted as either:  
'from 10cm to 50cm' or 'from 50cm to 10cm'.

**Repeatable**

A measurement is repeatable if the original experimenter repeats the investigation using same method and equipment and obtains the same results.

**Reproducible**

A measurement is reproducible if the investigation is repeated by another person, or by using different equipment or techniques, and the same results are obtained.

**Resolution**

This is the smallest change in the quantity being measured (input) of a measuring instrument that gives a perceptible change in the reading.



---

### **Sketch graph**

A line graph, not necessarily on a grid, that shows the general shape of the relationship between two variables. It will not have any points plotted and although the axes should be labelled they may not be scaled.

### **True value**

This is the value that would be obtained in an ideal measurement.

### **Uncertainty**

The interval within which the true value can be expected to lie, with a given level of confidence or probability, eg “the temperature is  $20^{\circ}\text{C} \pm 2^{\circ}\text{C}$ , at a level of confidence of 95%.

### **Validity**

Suitability of the investigative procedure to answer the question being asked. For example, an investigation to find out if the rate of a chemical reaction depended upon the concentration of one of the reactants would not be a valid procedure if the temperature of the reactants was not controlled.

### **Valid conclusion**

A conclusion supported by valid data, obtained from an appropriate experimental design and based on sound reasoning.

### **Variables**

These are physical, chemical or biological quantities or characteristics.

#### **Categoric variables**

Categoric variables have values that are labels, eg names of plants or types of material.

#### **Continuous variables**

Continuous variables can have values (called a quantity) that can be given a magnitude either by counting (as in the case of the number of shrimp) or by measurement (eg light intensity, flow rate etc).

#### **Control variables**

A control variable is one which may, in addition to the independent variable, affect the outcome of the investigation and therefore has to be kept constant or at least monitored.

#### **Dependent variables**

The dependent variable is the variable of which the value is measured for each and every change in the independent variable.

#### **Independent variables**

The independent variable is the variable for which values are changed or selected by the investigator.

#### **Nominal variables**

A nominal variable is a type of categoric variable where there is no ordering of categories (eg red flowers, pink flowers, blue flowers).

## Practical ladders and example experiments

During the development of our A-levels in Biology, Chemistry and Physics, we spoke to hundreds of teachers. Teachers also helped us to decide which practical activities to include in our 12 required practicals for each subject.

Both in development and in our launch meetings, we were asked for full, comprehensive practical instructions. In response, we have included a **sample** method for each practical on the following pages. These have been prepared so that a reasonably equipped school or college can cover the required activity with their students. It gives **one possible version** of the experiment that teachers could use. They will help inform planning the time required and ensure schools and colleges have the right equipment. Many are based on existing ISA and EMPA tasks as we know they worked well and that schools and colleges are familiar with them.

Photographs of a set-up of the sample practical methods provided can be found in our mini-guide for each practical, which are available on our [practical resources page](#)

The sample methods should **only** be seen as a starting point. We do not intend to stifle innovation and would encourage teachers to try different methods. Students will not be examined on the specific practical work exemplified in this section, but on the skills and understanding they build up through their practical work. It is important that students are able to apply these skills and this understanding to novel contexts in written exams. Teachers can vary all experiments to suit their needs.

### Using set methods to assess students' competence for the endorsement

Students who are given a method that is fully developed, with full, clear instructions, will be able to demonstrate some competencies (eg following written instructions), but not others (eg researching and reporting).

We have developed 'ladders' which will help you to modify each of the given practicals to allow your students greater freedom to develop and demonstrate these wider practical skills. Each ladder identifies how slight modifications to the way the experiment is presented can change the focus of it and allow students to demonstrate more independence. In turn, they will allow you to be more confident in your judgement of student abilities for the endorsement of practical skills.

### Investigation

Students do **not** need to carry out a full investigation. To achieve the endorsement, teachers must be confident that students can carry out practicals using 'investigative approaches'. In some practicals, teachers will wish to give full instructions for every stage in the activity. In other activities, teachers will give students some choice over how they carry out the activity, for example choosing the apparatus or the conditions for the experiment. On other occasions, teachers will wish to give students choice over how they analyse the data.

This approach means that students will be able to demonstrate all aspects of investigation over the A-level course without the practical problems associated with a full investigation.

---

## Safety

At all times, the teacher is responsible for safety in the classroom. Teachers should intervene whenever they see unsafe working. Risk assessments should be carried out before working, and advice from CLEAPSS and other organisations should be followed.

It is appropriate to give students at A-level more independence when making decisions about safety. They should be taught how to assess risks and how to write risk assessments when appropriate. They should also understand the appropriate use of safety equipment and how to put measures in place to reduce risks.

**To support teachers further, Mary Philpott, Biology Adviser, previously from CLEAPSS, outlines the difference between identification of major hazards, associated risk and control measures and a full risk assessment:**

The risk assessment should always be complete, as it is this that prevents injury or ill-health.

The risk assessment is fundamentally the **thinking** that has taken place before and during an activity, so that any foreseeable risk is reduced to a minimum. A written record is necessary only to show that the thinking has taken place.

We tend to get caught up in the paperwork that provides evidence for the risk assessment, but the guidance from the Health and Safety Executive is that the written record should be on a **point-of-use document** and there is no particular form etc that needs to be filled in.

The tables/forms etc that many schools use are simply planning documents that the teachers use to provide the point of use risk assessment for each of their lessons. Incidentally, CLEAPSS members must refer to our current advice when preparing their point-of-use documents.

The student is not responsible for their risk assessment. In a large part, therefore, the student's risk assessment will be that they carry through the safety measures that the teacher has put in place. It is therefore fine if the student makes a note on their point-of use document that shows they have thought about how to behave safely, and carried it through. The teacher will also be able to record what they have seen in a practical that shows that the student's risk assessment is effective. For example, the student's written risk assessment could be as simple as making notes on a method sheet about where they will put on eye protection or how they will arrange any heating equipment so that there is a minimum risk of scalding or burning themselves or the person next to them.

The teacher's observation notes will refer to whether they have carried out their written plans.

It might help the students to think safely if the teacher gives them a little time at the start of each practical to highlight or make notes about the safety aspects, and a class discussion about safety could show up any safety aspects that perhaps the teacher had not considered.

The students may also note where they have reminded other students about any safety issues.

The teacher should pass the student's CPAC when the students are seen to carry out the safety measures that they have written on their point of use document.

If the students are planning their own practical activities, they could use the safety advice given in the [CLEAPSS Student Safety Sheets](#).

In this case, they could identify hazards, risks and control measures.

In this case, they would make their own point of use document, with the control measures clearly identified.

The teacher would need to check that the risk assessment is adequate before they let the students proceed with the activity.

---

These are examples of 12 experiments that can be done as part of the AS/A-level Biology course. The methods are written using commonly used reagents and techniques, although teachers can modify the methods and reagents as desired.

### **Trialling**

All practicals should be trialled before use with students.

### **Risk assessment and risk management**

Risk assessment and risk management are the responsibility of the centre.

Safety is the responsibility of the teacher and the centre. It is important that students are taught to act safely in the laboratory at all times, including the wearing of goggles at all times and the use of additional safety equipment where appropriate.

### **Notes from CLEAPSS**

Technicians/teachers should follow CLEAPSS guidance, particularly that found on Hazcards and recipe sheets. The worldwide regulations covering the labelling of reagents by suppliers are currently being changed. Details about these changes can be found in leaflet GL101, which is available on the CLEAPSS website. You will need to have a CLEAPSS login.

## Practical 1

Required practical		Investigation into the effect of a named variable on the rate of an enzyme-controlled reaction			
<b>Apparatus and techniques covered</b>  (Not full statements)	AT a. use appropriate apparatus to record a range of quantitative measurements AT b. use appropriate instrumentation to record quantitative measurements AT c. use laboratory glassware apparatus for a variety of experimental techniques AT f. use qualitative reagents to identify biological molecules AT l. use ICT such as data logger to collect data or use software to process data.				
<b>Indicative apparatus and materials</b>	Laboratory glassware, enzyme (eg amylase, lipase, protease, carbohydrase), appropriate substrate(s), heating apparatus, thermometers or data logging equipment, pH meters, volumetric flasks, top pan balances.				
		Amount of choice			
		Increasing independence			
		Least choice	Some choice	Many choices	Full investigation
		Teacher chooses the enzyme, substrate and the factor to be varied. Students vary the factor and measure the outcomes. Experiments are fully specified in terms of equipment and method.	Teacher allows a limited choice of enzyme and/or factor. Students vary the factor and measure the outcomes. Experiment probably fully specified by teacher.	Teacher allows a choice of enzyme and/or factor. Students have a number of experimental procedures to choose from, and then follow that procedure.	Student decides on a question. Student researches methods for carrying out the experiment then chooses equipment and materials, justifying all choices.
Opportunities for observation and assessment of competencies					
Follow written procedures	✓✓✓ Students follow written method.	✓✓✓ Students follow written method.	✓✓✓ Students follow a method they have researched.	✓✓✓ Students follow a method they have researched.	
Applies investigative approaches and methods when using instruments and	✓ Students must correctly use the appropriate equipment.	✓ Students must correctly use the appropriate equipment.	✓✓ Students must correctly use the appropriate equipment.	✓✓✓ Students must choose an appropriate approach, equipment and techniques and identify correct variables for	

equipment				measurement and control.
Safely uses a range of practical equipment and materials	✓ Students must safely use the equipment.	✓ Students must safely use the equipment.	✓✓ Students minimise risks with minimal prompting.	✓✓✓ Students must carry out a full risk assessment and minimise risks.
Makes and records observations	✓ Students record observations in specified ways.	✓ Students record observations in specified ways.	✓ Students record observations in specified ways.	✓✓✓ Students must choose the most effective way of recording observations.
Researches, references and reports	✓ Students compare results with ideal and identify reasons for differences.	✓✓ Students compare results with ideal and between students and identify reasons for differences.	✓✓ Students compare results with ideal and between students and identify reasons for differences.	✓✓✓ Students must research alternatives in order to plan their work. Reporting covers the planning, carrying out and an analysis of their results.

✓✓✓: Very good opportunity ✓✓: Good opportunity ✓: Slight opportunity ✕: No opportunity

---

## A-level Biology example for required practical 1

### **Investigation into the effect of a named variable on the rate of an enzyme-controlled reaction: The effect of temperature on the rate of the reaction catalysed by trypsin**

#### **Student sheet**

Casein is a protein found in milk. Trypsin is an enzyme that digests casein. When trypsin is added to a dilute solution of milk powder, the casein is digested and the solution goes clear.

#### **Method**

You are provided with the following:

- 0.5% trypsin solution
- 3% solution of milk powder
- pH 7 buffer solution
- a large beaker to use as a water bath
- test tubes
- bungs or cork for test tubes
- test-tube rack
- stopwatch
- marker pen
- pipettes or syringes
- thermometer.

You are required to find the rate of reaction at **five** different temperatures. Your teacher will tell you whether you are going to investigate all the temperatures yourself or whether you will get some results from other students in your class.

You should read these instructions carefully before you start work.

1. Using a marker pen write an 'X' on the glass halfway down one side of each of three test tubes.
2. Add 10cm<sup>3</sup> of the solution of milk powder to each of these three test tubes.
3. Add 2cm<sup>3</sup> of trypsin solution to 2cm<sup>3</sup> of pH 7 buffer in another set of three test tubes.
4. Stand the three test tubes containing the solution of milk powder and the three test tubes containing trypsin and buffer in a water bath at 20°C.
5. Leave all six tubes in the water bath for 10 minutes.
6. Add the trypsin and buffer solution from one test tube to the solution of milk powder in another test tube.
7. Put a bung or cork in the test tube and invert about 5 times to mix thoroughly.
8. Put the test tube back into the water bath.
9. Repeat steps 6 and 7 using the other test tubes you set up.
10. Time how long it takes for the milk to go clear. Do this by measuring the time taken to first see the 'X' through the solution.
11. Record the time for each of the three experiments.
12. Using the same method, find out how long it takes the trypsin to digest the protein in the solution of milk powder at 30°C, 40°C, 50°C, 60°C.
13. Record your data in a suitable table.
14. Process your data and draw a graph of your processed data.

---

A-level Biology example for required practical 1

**Investigation into the effect of a named variable on the rate of an enzyme-controlled reaction:**

**The effect of temperature on the rate of the reaction catalysed by trypsin**

### Teacher notes

This investigation is based on ISA BIO3T/P09

### Materials

In addition to access to general laboratory equipment, each student needs:

- 30cm<sup>3</sup> of 0.5% trypsin solution
- 100cm<sup>3</sup> of 3% solution of milk powder (fat-free)
- 30cm<sup>3</sup> of pH 7 buffer solution
- a large beaker to use as a water bath
- test tubes (6 for each temperature they test)
- bungs or cork for test tubes
- test-tube rack
- stopwatch
- marker pen (must be waterproof)
- graduated pipettes or syringes capable of measuring up to 10cm<sup>3</sup>
- thermometer (to cover range 0°C to 100°C)
- large beakers to use as water baths
- access to hot and cold water to set up water baths.

In this investigation students will require data from five different temperatures 20°C, 30°C, 40°C, 50°C, 60°C. Students could carry out the experiment at each temperature individually or different members of the class could carry out the experiment at different temperatures and pool the data.

If the investigation is to meet AT b, a colorimeter could be used to measure progress of the reaction. The following changes would need to be made to the method.

1. Leave all six tubes in the water bath for 10 minutes. While you are waiting set up a colorimeter. Use the trypsin solution as a blank to calibrate the colorimeter to zero absorbance.
2. Add the trypsin and buffer solution from one test tube to the solution of milk powder in another test tube.
3. Put a bung or cork in the test tube and invert about 5 times to mix thoroughly.
4. Put the test tube back into the water bath. Time the reaction for **exactly** 4 minutes. Pour the contents of the tube into a cuvette and measure the absorbance **immediately**.
5. Repeat steps 6, 7 and 8 using the other test tubes you set up.
6. Record the absorbance for each of the three experiments.

**The lower the absorbance reading, the more casein has been broken down.**

**This experiment also allows students to do other investigations where they can choose variables such as pH and concentration of trypsin.**



---

## Risk assessment

Risk assessment and risk management are the responsibility of the centre.

## Trialling

The practical should be trialled before use with students.

## Additional notes

- Enzymes, particularly proteases (such as trypsin) can produce allergic reactions in sensitive people. The proteases also break down proteins in the skin and eyes. Care to avoid spillages, eye protection should be worn, and wash off any splashes to skin immediately. Hazcard 33 gives the hazards, risks and control measures for the concentrate and solid and also dilute solutions used by students.
- Water temperatures higher than 50°C can cause scalding. Take care with hot water baths.
- The enzymes and milk powder should be made immediately before the lesson as trypsin quickly deteriorates when stored.
- If pH 7 buffer solution is purchased instead of being made from tablets then the colourless solution must be used. Some suppliers dye their buffer solutions so check before ordering.
- Mix the solutions gently by inverting the tubes to avoid bubbles and frothing if too vigorously shaken. Bungs or corks should be made available for this.
- Tubes should be inverted about five times.
- The time for the cross to become visible is subjective and depends on the person viewing.

## Sample results

Temperature /°C	Mean time to clear/s	Mean absorbance
25	189	1.71
40	79	0.17
50	108	0.39
60	271	1.10

Photographs of an example set-up of this practical can be found in our set-up guide, which is available on our [A-level practicals page](#).

## Practical 2

<b>Required practical</b>	<b>Preparation of stained squashes of cells from plant root tips; set up and use of and optical microscope to identify the stages of mitosis in these stained squashes and calculation of a mitotic index</b>			
<b>Apparatus and techniques covered</b> (Not full statements)	AT d. use of light microscope at high power and low power, including use of graticule AT e. produce scientific drawing from observation with annotations AT f. use qualitative reagents to identify biological molecules			
<b>Indicative apparatus and materials</b>	Microscope, (Bench lamp if using microscope with mirror instead of built in light), 100 ml beaker, 5 M hydrochloric acid, microscope slide and cover slip, Toluidene blue stain, filter paper, mounted needle, scalpel, distilled water, watch glass, forceps, Eyepiece graticule, Stage micrometer, pre-prepared slides of cells in mitosis (for comparison).			
	<b>Amount of choice</b> Increasing independence			
	Least choice	Some choice	Many choices	Full investigation
	Teacher chooses the plant and the cells to be measured. Students measure the cells. Experiments fully specified in terms of equipment and method.	Teacher allows a limited choice of plant and cells to be measured. Students choose the cells and measure them. Experiment probably fully specified by teacher.	Teacher allows student to grow variety of roots to use to observe and to measure root tip cells. Students have a choice of staining procedures to choose from, and then follow that procedure.	Student decides on a question. Student researches methods for carrying out the experiment then chooses equipment, materials, justifying all choices.
<b>Opportunities for observation and assessment of competencies</b>				
Follow written procedures	✓✓✓ Students follow written method.	✓✓✓ Students follow written method.	✓✓✓ Students follow a method they have chosen.	✓✓✓ Students follow a method they have researched.
Applies investigative approaches and methods when using instruments and equipment	✓✓ Students must correctly use the appropriate equipment.	✓✓ Students must correctly use the appropriate equipment.	✓✓ Students must correctly use the appropriate equipment.	✓✓✓ Students must choose an appropriate approach, equipment and techniques and identify correct variables for measurement and control.
Safely uses	✓✓ Students must	✓✓ Students must	✓✓ Students	✓✓✓ Students

a range of practical equipment and materials	safely use the equipment.	safely use the equipment.	minimise risks with minimal prompting.	must carry out a full risk assessment and minimise risks.
Makes and records observations	✓✓✓ Students record observations in drawings and measurements.	✓✓✓ Students record observations in drawings and measurements.	✓✓✓ Students record observations in drawings and measurements.	✓✓✓ Students must choose the most effective way of recording observations.
Researches, references and reports	✓ Students compare results with pre-prepared slides.	✓✓ Students compare results with pre-prepared slides and between students and identify reasons for differences.	✓✓ Students compare results with pre-prepared slides and between students and identify reasons for differences.	✓✓✓ Students must research alternatives in order to plan their work. Reporting covers the planning, carrying out and an analysis of their results.

✓✓✓: Very good opportunity ✓✓: Good opportunity ✓: Slight opportunity ✗: No opportunity

---

A-level Biology example for required practical 2

**Preparation of stained squashes of cells from plant root tips; set up and use of an optical microscope to identify the stages of mitosis in these stained squashes and calculation of a mitotic index:**

**Root tip squash using onion root meristem tissue**

### **Student sheet**

You are provided with the following:

- 100 ml beaker
- hydrochloric acid ( $5 \text{ mol dm}^{-3}$ )
- microscope slide and cover slip
- toluidene blue stain
- filter paper
- mounted needle
- scalpel
- distilled water
- watch glass
- forceps
- root tip of onion or garlic
- piece of white paper
- paper towel
- microscope and light source.

You are required to prepare a microscope slide of the meristem tissue from an onion root. You will add a stain to the material which allows you to see the chromosomes. You will look at the slide under the microscope to identify any cells showing stages of mitosis. You will then calculate the mitotic index.

### **Safety**

Hydrochloric acid ( $5 \text{ mol dm}^{-3}$ ) is corrosive and you should handle it with caution. You must wear eye protection.

You must stand the beaker on a bench mat. Do not carry the beaker with acid in it.

**Do not leave root tips for investigation lying on the bench top prior to staining. Cut your root tip immediately before you put it into the acid. This will stop any reactions and hopefully some cells will be in a stage of division.**

**You should read these instructions carefully before you start work.**

---

### **Making your slide**

1. Stand the beaker on a bench mat before adding approximately 10 ml of hydrochloric acid ( $5 \text{ mol dm}^{-3}$ ). Put some paper towel on the bench mat and label.
2. Place about 2cm of root tip in the acid and leave for 15 minutes.
3. Set up your microscope while you are waiting.
4. Rinse the root tip in distilled water in the watch glass.
5. Cut off the root tip (1mm) and place on a microscope slide.
6. Cover the section with toluidene blue stain and macerate with the mounted needle to separate the cells. Use a piece of white paper to aid colouration of roots.
7. Continue to macerate until the tissue is well broken and the cells are stained dark blue.
8. Add a cover slip and with gentle finger pressure 'spread' the material and blot at the same time by using a folded filter paper between finger and slide.
9. Look carefully at all slides for cells undergoing mitosis. Chromosomes should stain dark blue. Repeat for several fields of view.
10. Record your data in a suitable table.
11. Calculate the mitotic index.

---

## A-level Biology example for required practical 2

**Preparation of stained squashes of cells from plant root tips; set up and use of and optical microscope to identify the stages of mitosis in these stained squashes and calculation of a mitotic index:**

### Root tip squash using onion root meristem tissue

#### Teacher notes

#### Materials

In addition to access to general laboratory equipment, each student needs access to:

- 100 ml beaker
- hydrochloric acid ( $5 \text{ mol dm}^{-3}$ )
- microscope slide and cover slip
- toluidene blue stain
- filter paper
- mounted needle
- scalpel
- distilled water
- watch glass
- forceps
- root tip of onion or garlic
- microscope and light source
- piece of white paper
- paper towel.

#### Technical information

##### Reagents:

- 5 M hydrochloric acid (10 ml per student)
- toluidine blue (0.05%) at pH 4; made in McIlvaine buffer; keep in fridge

##### *Buffer formulae*

*Citric acid*  $0.1 \text{ M}$   $21 \text{ g dm}^{-3}$ ;  $61.45 \text{ cm}^3$

$\text{Na}_2\text{HPO}_4$   $0.2 \text{ M}$   $35 \text{ g dm}^{-3}$ ;  $38.55 \text{ cm}^3$

Alternatively use pH buffer tablets to make up buffer.

**Root tip of onion, garlic or shallot** – prepare one to two weeks in advance. Stand on top of a McCartney bottle full of water in a dark cupboard until roots are about 5cm long. Prepare plenty as some may not produce many roots.

Organic or home grown garlic, onions or shallots produce the best root systems in a few days. Store bought produce will grow but can take up to 14 days and tend to produce fewer usable roots.

In this investigation each student will need to prepare a microscope slide of the meristem tissue from an onion root. They will add toluidene blue stain to the material which allows them to see the chromosomes. They will look at the slide under the microscope to identify any cells showing stages of mitosis. They will then calculate the mitotic index. Good quality microscopes with adjustable lighting make it easier to get good mitotic cells in view but any microscope with a  $\times 40$  objective or similar is satisfactory as a good contrast is obtained using the toluidine blue.

#### Risk assessment

Risk assessment and risk management are the responsibility of the centre.

---

## Trialling

The practical should be trialled before use with students.

## Safety

Take care when making the  $5 \text{ mol dm}^{-3}$  hydrochloric acid and consult the Hazcard. Work in a fume cupboard as fumes are released rapidly at dilution when being prepared from concentrated solution.

Hydrochloric acid is corrosive and should be handled with caution.

It is essential to use very concentrated acid to ensure the cells die quickly.

You may wish to dispense the acid to students once they have the beaker on a bench mat to avoid students walking around the room with such concentrated acid.

It is also advisable to collect the beakers of acid directly from the students when they have finished in order to avoid any  $5 \text{ mol dm}^{-3}$  hydrochloric acid being poured down the sinks and not washed away thoroughly. A tray at the front of the room clearly labeled for used beakers of acid should help with the clearing away and make the technicians aware of the acid in the beakers.

## Additional notes

Do not leave root tips for investigation lying about on the bench top prior to staining. Cut the root tip immediately before you put it into the acid. This will stop any reactions and hopefully some cells will be in the stage of division.

It is a good idea to put the roots into the acid for the students. The reason being that it is very difficult to tell which roots on the onion have already had the tips removed.

**Toluidene blue** is used as the stain in this investigation as it gives reliable results and does not require any heating of the slide to make the chromosomes visible. Other stains are available but you should check if heating is required.

Nucleic material stains blue and the other material lilac. If the stain is fresh then good colour definition is obtained. The stain also stores well in the fridge for several weeks after making.

It would be advisable for students to have seen prepared slides of root tips before carrying out the practical. One problem students might have is preparing a slide which does not contain meristematic cells – they need to know that cells behind the meristem elongate and are no longer dividing. As it is easy to confuse the two ends of the piece of root get students to mount both ends of the piece of root. Once under the microscope it is easy to tell which cells are from the root tip meristem. These cells are small and square with the nucleus in the centre. The other end will have elongated cells with the nucleus off-centre.

It would be a good idea to have some pre-prepared slides available as students may not be successful in preparing a slide that contains cells with stages of mitosis and so would not be able to calculate the mitotic index.

Mitotic index = Number of cells in stages of mitosis  $\div$  total number of cells.

Photographs of an example set-up of this practical can be found in our set-up guide, which is available on our [A-level practicals page](#).

## Practical 3

<b>Required practical</b>	<b>Production of a dilution series of a solute to produce a calibration curve with which to identify the water potential of plant tissue</b>			
<b>Apparatus and techniques covered</b>  (Not full statements)	AT c. use laboratory glassware apparatus for a variety of experimental techniques AT h. safely and ethically use organisms to measure plant physiological functions AT J. safely use instruments for dissection of a plant organ AT I. use ICT such as data logger to collect data or use software to process data			
<b>Indicative apparatus and materials</b>	Large potato tuber (or other suitable plant organ), sodium chloride (NaCl) solution (or sucrose solution), Distilled water, boiling tubes, water bath, thermometer, graduated pipette and pipette filler, white tile, scalpel, ruler, stop clock, digital balance, forceps, potato chip cutter.			
	<b>Amount of choice</b>			
	<b>Increasing independence</b>			
	Least choice	Some choice	Many choices	Full investigation
	Teacher chooses the solute and the concentrations to be produced, providing details of volumes of stock solution and water. Teacher chooses the plant organ and details of how to cut to size. Students prepare the solutions and measure the change in mass of plant material. Experiments fully specified in terms of equipment and method.	Teacher provides a stock solution of known concentration. Students choose the concentrations and determine the volumes of solution and water to produce these concentrations. Teacher chooses the plant organ and details of how to cut to size. Students prepare the solutions and measure the change in mass of plant material. Experiment probably fully specified by teacher.	Teacher allows a choice of solute and plant organ. Students choose the concentrations and determine the volumes of solution and water to produce these concentrations. Students choose the plant organ and details of how to cut to size. Students prepare the solutions and measure the change in mass of plant material. Outline procedure provided by teacher.	Student decides on a plant tissue of which to find the water potential. Student researches methods for carrying out the experiment then chooses equipment, materials, justifying all choices.



Opportunities for observation and assessment of competencies				
Follow written procedures	✓✓✓ Students follow written method.	✓✓✓ Students follow written method.	✓✓✓ Students follow a method they have researched.	✓✓✓ Students follow a method they have researched.
Applies investigative approaches and methods when using instruments and equipment	✓ Students must correctly use the appropriate equipment.	✓✓ Students must correctly use the appropriate equipment and calculate correct volumes to produce serial dilution.	✓✓✓ Students must correctly use the appropriate equipment and identify correct variables for measurement and control.	✓✓✓ Students must choose an appropriate approach, equipment and techniques, identify correct variables for measurement and control.
Safely uses a range of practical equipment and materials	✓✓ Students must safely use the equipment.	✓✓ Students must safely use the equipment.	✓✓ Students minimise risks with minimal prompting.	✓✓✓ Students must carry out a full risk assessment and minimise risks.
Makes and records observations	✓ Students record change in mass in specified ways.	✓✓ Students record concentrations of solute and change in mass in specified ways.	✓✓ Students record concentrations of solute and change in mass in specified ways.	✓✓✓ Students must choose the most effective way of recording observations.
Researches, references and reports	✓ Students compare results with ideal and identify reasons for differences.	✓✓ Students compare results with ideal and between students and identify reasons for differences.	✓✓ Students compare results with ideal and between students and identify reasons for differences.	✓✓✓ Students must research alternatives in order to plan their work. Reporting covers the planning, carrying out and an analysis of their results.

✓✓✓: Very good opportunity ✓✓: Good opportunity ✓: Slight opportunity ✗: No opportunity

---

## A-level Biology example for required practical 3

### Production of a dilution series of a solute to produce a calibration curve with which to identify the water potential of plant tissue:

#### Determining the water potential of potato tuber cells

##### Student sheet

You are provided with the following:

- large potato tuber
- potato chip cutter
- 1 mol dm<sup>-3</sup> sucrose solution
- distilled water
- boiling tube rack
- six boiling tubes,
- marker pen
- thermometer
- 10cm<sup>3</sup> graduated pipette and pipette filler
- White tile
- scalpel or small kitchen knife
- ruler
- paper towels
- timer
- digital balance
- forceps.

You should read these instructions carefully before you start work.

##### Preparing the dilution series

1. Label six boiling tubes 0.0, 0.2, 0.4, 0.6, 0.8 and 1.0 mol dm<sup>-3</sup> sucrose.
2. Use the 1.0 mol dm<sup>-3</sup> sucrose solution and water to make up 20cm<sup>3</sup> of sucrose solution of each of the following concentrations:
  - 0.2 mol dm<sup>-3</sup>
  - 0.4 mol dm<sup>-3</sup>
  - 0.6 mol dm<sup>-3</sup>
  - 0.8 mol dm<sup>-3</sup>
  - 1.0 mol dm<sup>-3</sup>

Complete **Table 1** to show the volumes of 1.0 mol dm<sup>-3</sup> sucrose solution and water that you used to make up each concentration.

3. Stand the boiling tubes containing the sucrose solutions in a water bath set at 30°C. Use a thermometer to check the temperatures in all tubes reaches 30°C.
4. Using the potato chip cutter, cut six chips from your potato tuber. Make sure you remove any peel on the potatoes. Use a ruler, scalpel and tile to cut all of the chips to the same length. Blot the potato chips dry with a paper towel, ie roll each chip until it no longer wets the paper towel and dab each end until dry. **Do not squeeze the chips**. Put each potato chip onto a clean square of paper towel which you have numbered in the same way as the boiling tubes.
5. Weigh each potato chip. Record these initial masses in a suitable table.
6. At the water bath, set the stop clock to zero. Quickly transfer each potato chip from its square of paper towel to its own boiling tube with the same number.

7. After 20 minutes, remove the chips from the boiling tubes. Blot the chips dry, as before. Then reweigh them. Record these final masses in your table.
8. Calculate the change in mass and then calculate the percentage change in mass.
9. Plot a graph of your processed data and use this to determine the concentration of sucrose which has the same water potential as the potato tuber cells.

**Table 1**

Concentration of sucrose solution/mol dm <sup>-3</sup>	<b>0</b>	<b>0.2</b>	<b>0.4</b>	<b>0.6</b>	<b>0.8</b>	<b>1.0</b>
Volume of 1.0 mol dm <sup>-3</sup> sucrose solution/cm <sup>3</sup>	<b>0</b>					<b>20</b>
Volume of water/cm <sup>3</sup>	<b>20</b>					<b>0</b>

---

## A-level Biology example for required practical 3

### **Production of a dilution series of a solute to produce a calibration curve with which to identify the water potential of plant tissue:**

#### **Determining the water potential of potato tuber cells**

#### **Teacher notes**

This investigation is based on BIO3T/P14

In addition to access to general laboratory equipment, each student needs:

- large potato tuber
- access to a potato chip cutter
- 1 mol dm<sup>-3</sup> sucrose solution
- distilled water
- boiling tube rack
- six boiling tubes
- thermometer
- 10cm<sup>3</sup> graduated pipette and pipette filler
- White tile
- scalpel or small kitchen knife
- ruler
- paper towels
- timer
- access to a digital balance (3 decimal places if possible, but 2 decimal places will give adequate results)
- forceps
- access to an electric water bath set at 30°C or large beaker to use as a water bath.

This investigation can be changed to allow students more freedom to select variables for themselves, eg the concentrations used, size of potato chip, length of time in solution etc.

The experiment also works with sodium chloride as the solute and other plant material can be used.

10 ml or 20 ml syringes can be used in place of graduated pipettes as some students struggle to use these accurately and with pipette fillers. Small plugs of cotton wool in the top of the pipette can prevent the salt/sugar solution from getting into the pipette filler.

A potato chip cutter is used to prevent wastage and to ensure constant cross-sectional area of chip. The chippers are easily available from hardware stores.

The chips have been left intact to speed up the weighing process. However students could increase surface area by slicing the chips.

A class set of chips can also be easily prepared with a potato chip cutter and the pupils can select chips to work with. If this is done, leave the skin on the potato as this can be the students' responsibility to remove during the measuring process. Cork borers can also be used to produce the chips. If using cork borers, then size numbers 4, 5 or 6 are most suitable. The teacher should ensure that each pupil only has access to one size of borer to reduce the problems when the chips are made. The teacher can also consider whether scalpels are the most appropriate instrument to cut potatoes, rather than small kitchen knives (if available). If scalpels are used the teacher should demonstrate safe use and supervise the activity closely. Similar care should be taken when cutting plant tissue using cork borers.

---

A water bath is used to speed up the diffusion of water in and out of the potato tissue. Good results can be obtained at 30°C within 20 minutes although if time allows 30 minutes would be better.

### Risk assessment

Risk assessment and risk management are the responsibility of the centre.

### Trialling

The practical should be trialled before use with students.

### Sample results for sucrose

Sucrose concentration/ mol dm <sup>-3</sup>	Initial mass/g	Final mass/g	Change in mass/g	Percentage change
0.0	6.54	6.81	0.27	4.13
0.2	6.57	6.63	0.06	0.91
0.4	6.46	6.17	-0.35	-5.42
0.6	6.41	5.96	-0.45	-7.02
0.8	6.21	5.57	-0.64	-10.30
1.0	6.33	5.53	-0.80	-12.60

Photographs of an example set-up of this practical can be found in our set-up guide, which is available on our [A-level practicals page](#).

**Further work to include serial dilution.**

Although the determination of water potential tends to be associated with dilution series work, serial dilution opportunities do exist.

The serial dilution with stock solution 1.5M sucrose gives a four stage serial dilution and control opportunity, concentrations generated being with equivalent [sucrose] of potato, swede, parsnip and carrot.

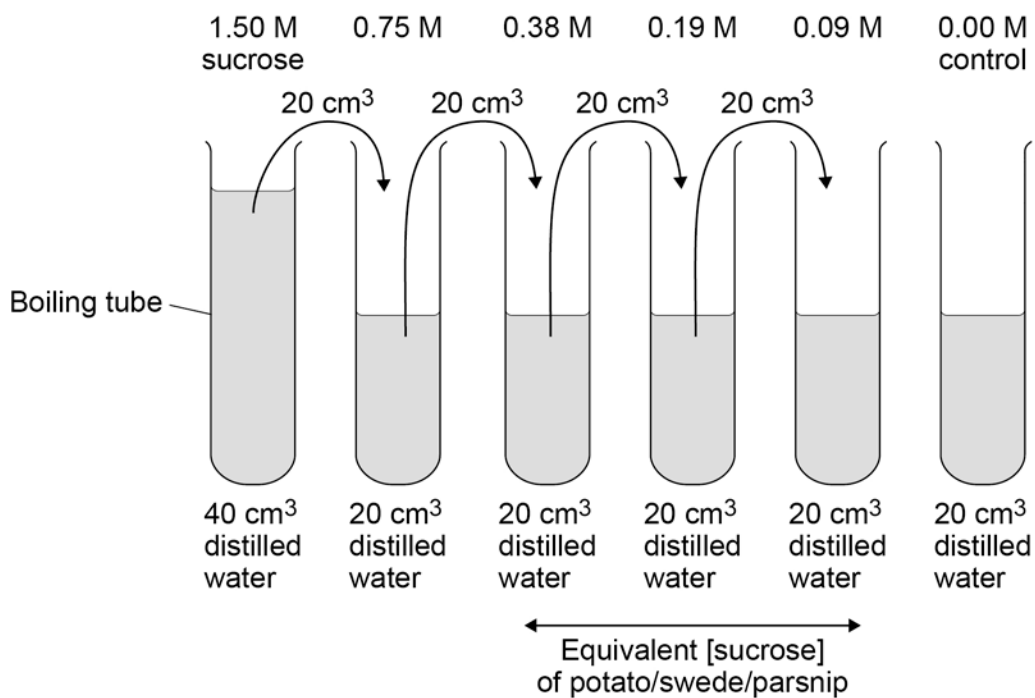

## Practical 4

Required practical		Investigation into the effect of a named variable on the permeability of cell-surface membranes			
<b>Apparatus and techniques covered</b>  (Not full statements)	AT a. use appropriate apparatus to record a range of quantitative measurements AT b. use appropriate instrumentation to record quantitative measurements AT c. use laboratory glassware apparatus for a variety of experimental techniques AT j. safely use instruments for dissection of a plant organ AT l. use ICT such as data logger to collect data or use software to process data				
<b>Indicative apparatus and materials</b>	Beetroot (or other suitable source of cells), white tile, scalpel, ruler, mounted needle, boiling tubes, distilled water, graduated pipette and pipette filler, large beaker to use as a water bath, thermometer, stop clock, colorimeter and cuvettes.				
		Amount of choice Increasing independence			
		Least choice	Some choice	Many choices	Full investigation
		Teacher chooses the values of named variable to be investigated and the type of cell to be used. Teacher decides on method to be used to determine the effect of named variable. Students control the variable and measure the outcomes. Experiments fully specified in terms of equipment and method.	Teacher allows a limited choice of values of named variable. Teacher chooses type of cell to be used. Students choose values of named variable and measure the outcomes. Experiment probably fully specified by teacher.	Teacher allows a choice of named variable. Teacher chooses type of cell to be used. Students have a number of experimental procedures to choose from, and then follow that procedure.	Student decides on a named variable and a type of cell to investigate. Student researches methods for carrying out the experiment then chooses equipment and materials, justifying all choices.
Opportunities for observation and assessment of competencies					
Follow written procedures	✓✓✓ Students follow written method.	✓✓✓ Students follow written method.	✓✓✓ Students follow a method they have chosen.	✓✓✓ Students follow a method they have researched.	
Applies investigative	✓✓ Students must correctly use	✓✓ Students must correctly use the	✓✓✓ Students must correctly use	✓✓✓ Students must choose an	

approaches and methods when using instruments and equipment	the appropriate equipment.	appropriate equipment.	the appropriate equipment.	appropriate approach, equipment and techniques and identify correct variables for measurement and control.
Safely uses a range of practical equipment and materials	✓✓ Students must safely use the equipment.	✓✓ Students must safely use the equipment.	✓✓ Students minimise risks with minimal prompting.	✓✓✓ Students must carry out a full risk assessment and minimise risks.
Makes and records observations	✓ Students record observations in specified ways.	✓ Students record observations in specified ways.	✓ Students record observations in specified ways.	✓✓✓ Students must choose the most effective way of recording observations.
Researches, references and reports	✗	✓ Students compare results between students and identify reasons for differences.	✓✓ Students compare results between students and identify reasons for differences.	✓✓✓ Students must research alternatives in order to plan their work. Reporting covers the planning, carrying out and an analysis of their results.

✓✓✓: Very good opportunity ✓✓: Good opportunity ✓: Slight opportunity ✗: No opportunity



---

A-level Biology example for required practical 4

## Investigation into the effect of a named variable on the permeability of cell-surface membranes:

### The effect of alcohol concentration on the leakage of pigment from beetroot cells

#### Student sheet

#### Introduction

Beetroot contains high concentrations of betalain. This is a purple pigment found inside the vacuoles of the cells. The pigment cannot move across undamaged plasma membranes. You will investigate the effect of alcohol concentration on the leakage of pigment leaking through beetroot plasma membranes.

In **Part 1** of the investigation, you will produce a set of standards and use them to produce a calibration curve. In **Part 2** you will use these standards to compare the colour of the solutions obtained when beetroot discs have been soaked in different concentrations of alcohol.

#### Method

You are provided with:

- stock solution of beetroot extract
- five concentrations of alcohol labelled 100%, 80%, 60%, 40%, 20%
- discs cut from a beetroot and rinsed thoroughly in water
- forceps
- graduated pipettes or syringes
- boiling tubes
- bungs to fit some of the test tubes
- thermometer
- large beaker to use as a water bath
- stopwatch
- test-tube rack
- small beakers
- permanent marker pen
- water.

You should read these instructions carefully before you start work.

#### Part 1: Making the colour standards

1. Use the extract and water to prepare a series of six boiling tubes containing 5cm<sup>3</sup> of different concentrations of extract. The concentrations should be equally spaced and cover a range from pure water (0%) to pure extract (100%). These will be your colour standards.
2. Label these standards 0, 2, 4, 6, 8, 10.
3. Complete **Table 1** to show the concentration of extract in each tube.
4. Complete **Table 1** to show how you made the colour standards in **Part 1** of the investigation.

**Table 1**

Label of tube	Volume of beetroot extract/cm <sup>3</sup>	Volume of water/cm <sup>3</sup>	Concentration of extract/%
0			0
2			
4			
6			
8			
10			100

**Part 2: The investigation**

5. Set up a water bath at 30°C.
6. With a second set of boiling tubes add 2cm<sup>3</sup> of 100% alcohol to a test tube and put a bung in the tube.
7. Label the tube with the alcohol concentration.
8. Repeat steps 6 and 7 with alcohol concentrations of 80%, 60%, 40% and 20%.
9. Put the tubes of alcohol in the water bath until the temperature of the alcohol reaches 30°C.
10. Blot 10 discs of beetroot with a paper towel to remove excess water.
11. Using the forceps, gently put two discs of beetroot in each of the five tubes. Replace the bungs as soon as possible after doing so.
12. Leave the tubes in the water bath for 5 minutes. Shake the tubes gently once every minute. Then remove the tubes from the water bath.
13. Immediately pour each solution into a separate clean boiling tube, being careful to label the tubes appropriately. Throw the beetroot discs away.
14. Compare each of your solutions with the colour standards you made in **Part 1**. Note which standard has the same colour as each of your solutions. If the colour of the solution falls between two of the values you can use the intermediate number. For example, if the colour value is between 2 and 4, record the colour value 3.
15. Record your results in a suitable table.

---

A-level Biology example for required practical 4

**Investigation into the effect of a named variable on the permeability of cell-surface membranes:**

**The effect of alcohol concentration on the leakage of pigment from beetroot cells**

**Teacher notes**

This investigation is based on ISA BIO3T/Q10

**Materials**

In addition to access to general laboratory equipment, each student needs:

- 20cm<sup>3</sup> stock solution of beetroot extract
- approximately 30cm<sup>3</sup> 100% alcohol (ethanol and methanol work equally well)
- 5cm<sup>3</sup> of each concentrations of alcohol labelled 80%, 60%, 40%, 20%.
- approximately 25 evenly sized discs of fresh beetroot tissue, rinsed thoroughly in several changes of water and left in water. Cork borer 6 mm works well, discs approximately 2 mm thick.
- forceps to handle the beetroot discs
- 10cm<sup>3</sup> graduated pipettes or syringes
- boiling tubes
- bungs to fit some of the boiling tubes
- thermometer
- large beaker to use as a water bath
- stopwatch or timer
- test-tube rack
- 2 × 100cm<sup>3</sup> beakers
- permanent marker pen
- water
- paper towels to blot discs.

**Technical information**

A stock solution of beetroot extract should be prepared in the following way (quantities per student). Measure 20cm<sup>3</sup> of the 100% alcohol into a beaker and add 20 discs of beetroot tissue. Leave the discs for 10 minutes, shaking the beaker every minute. Remove the beetroot discs, leaving a concentrated solution of betalin.

Fresh beetroot should be used (not pre-packed or frozen) for the best results.

A small sieve is useful for washing and collecting the beetroot discs.

Ethanol and methanol work well and this was trialled with ethanol in the form of industrial methylated spirit and not pure absolute ethanol for cost purposes.

**Notes on alternative methods.**

The method used in the original ISA did not require students to use a colorimeter. However, use of an instrument to make quantitative measurements, such as a colorimeter, is AT b (see page 67 of the specification) and this is a suitable practical activity in which to satisfy this criterion. The method can be altered as follows:

**Part 1: making the colour standards**

1. Use the extract and water to prepare a series of six test tubes containing 5cm<sup>3</sup> of different concentrations of extract. The concentrations should be equally spaced and cover a range from pure water (0%) to pure extract (100%). These will be your colour standards.

2. Set up a colorimeter. Use water to calibrate the colorimeter to zero absorbance. Measure the absorbance of each of the standards you have prepared.
3. Complete **Table 1** to show the concentration of extract in each tube and the absorbance.
4. Complete **Table 1** to show how you made the colour standards in **Part 1** of the investigation.

**Table 1**

Label of tube	Volume of beetroot extract/cm <sup>3</sup>	Volume of water/cm <sup>3</sup>	Concentration of extract/%	Absorbance reading from colorimeter
0			0	
2				
4				
6				
8				
10			100	

5. Plot a graph of concentration of extract against absorbance.

Changes to rest of method - point 13.

13. Measure the absorbance of each of your solutions with the colorimeter. Use the graph to read concentration of extract for each sample. Record your results in a suitable table.

### Notes on alternative variables

The above investigation works well if detergent is used instead of alcohol. A clear washing up liquid must be used as coloured liquids will interfere with the results. Dilute the detergent 50:50 with water to make the '100%' stock solution'.

A similar experiment can also be done with temperature as the independent variable.

---

## Risk assessment

Risk assessment and risk management are the responsibility of the centre.

- If students cut their own discs care should be taken using cork borers and scalpels. Small kitchen knives could be used if available.
- Hazcard 40A covers safety issues with ethanol. No naked flames in laboratory, and ensure good ventilation to remove effects of any spillages. Wear eye protection.

## Trialling

The practical should be trialled before use with students.

## Sample results

### 1. Calibration curve

Percentage extract	Absorbance at 520 nm
0	0.00
20	0.32
40	0.61
60	0.95
80	1.23
100	1.47

### 2. Results at 30°C with 2 discs per tubes

Percentage concentration of ethanol	Absorbance at 520 nm
0	0.00
20	0.37
40	0.65
60	0.90
80	1.04
100	1.31

Photographs of an example set-up of this practical can be found in our set-up guide, which is available on our [A-level practicals page](#).

## Practical 5

Required practical		Dissection of animal or plant gas exchange or mass transport system or of organ within such a system			
Apparatus and techniques covered  (Not full statements)	AT e. produce scientific drawing from observation with annotations AT h. safely and ethically use organisms to measure: plant or animal responses, physiological functions AT j. safely use instruments for dissection of an animal organ, or plant organ				
<b>Indicative apparatus and materials</b>	Sheep's heart (or other suitable organ or system), dissection kit, dissection board or wax tray, magnifying lens, dissection pins, access to a camera.				
		Amount of choice			
		Increasing independence			
		Least choice	Some choice	Many choices	Full investigation
		Teacher chooses the system or organ to be dissected. Students dissect the organ using instructions given by teacher. Students draw and label the finished dissection.	Teacher chooses the system or organ to be dissected. Students choose how to dissect the system or organ. Students draw and label the finished dissection.	Teacher allows a choice of system or organ to be dissected. Students choose how to dissect the system or organ. Students draw and label the finished dissection.	Student decides on a system or organ to investigate. Student researches methods for carrying out the dissection then chooses equipment, materials, justifying all choices. Student draws the finished dissection and fully annotates the drawing.
Opportunities for observation and assessment of competencies					
Follow written procedures	✓ Students follow written method or diagrams.	✓ Students follow own method.	✓ Students follow a method they have researched.	✓✓ Students follow a method they have researched.	
Applies investigative approaches and methods when using instruments and	✓✓ Students must correctly use the dissecting instruments.	✓✓✓ Students use dissecting instruments to investigate the system or organ.	✓✓✓ Students use dissecting instruments to investigate the system or organ of their choice.	✓✓✓ Students must choose an appropriate system or organ to investigate. Use of dissecting	

equipment				instruments and techniques allow the student to discover how this system or organ functions.
Safely uses a range of practical equipment and materials	✓✓ Students must safely use the equipment.	✓✓ Students must safely use the equipment.	✓✓ Students minimise risks with minimal prompting.	✓✓✓ Students must carry out a full risk assessment and minimise risks.
Makes and records observations	✓✓ Students record observations in annotated drawing.	✓✓ Students record observations in annotated drawing.	✓✓ Students record observations in annotated drawings.	✓✓✓ Students must choose the most effective way of recording observations.
Researches, references and reports	✓ Students compare own drawing with published drawings and identify reasons for differences.	✓ Students compare own drawing with published drawings and identify reasons for differences.	✓ Students compare own drawing with published drawings and identify reasons for differences.	✓✓ Students must research alternatives in order to plan their work. Reporting covers the planning, carrying out and final annotated drawing.

✓✓✓: Very good opportunity ✓✓: Good opportunity ✓: Slight opportunity ✗: No opportunity

---

## A-level Biology example for required practical 5

### Dissection of animal or plant gas exchange or mass transport system or of organ within such a system:

#### Heart dissection

#### Student sheet

You are provided with the following:

- a sheep's heart
- dissecting tray and board
- dissecting instruments
- labels and pins
- plastic gloves
- beaker of disinfectant
- disinfectant spray
- access to a camera
- access to a yellow disposal bag.

You should read these instructions carefully before you start work.

1. Before you cut the heart examine its external features.
  - Identify the coronary arteries.
  - Run water into the top of the heart and see if you can see the valves in the aorta and pulmonary arteries close.
  - Squeeze the heart gently so these valves open and the water comes out.
2. Cut down each side of the heart to open up the left atrium and left ventricle and the right atrium and right ventricle.
  - Look for the tendinous cords holding the atrio-ventricular valves, and lift the weight of the heart by holding one of these cords over a dissecting needle.
  - Look how thin the atrio-ventricular valves are.
  - Examine the thickness of the walls of the ventricles.
  - Which side of the heart has thicker ventricular walls? Explain the advantages of this thickness.
  - Look at the walls of the atria, they are much thinner than those of the ventricles. Can you explain the advantage of this?
  - Push the handle of the dissecting needle up behind the atrio-ventricular valves. You should notice that the aorta and pulmonary arteries cross over.
3. Make some little flags from pins and sticky labels and label the parts of the heart that you can identify. Make sure they are legible and visible as you look down on your dissection.

Ask your tutor to check your labelling and take a photograph so you can include it in your notes.



---

**Packing away:**

- Remove all pins and discard labels.
- Place pins and dissecting instruments in the beaker of disinfectant.
- Place the heart in the yellow disposal bag on the trolley.

Use the disinfectant spray to clean the dissecting board and bench, using paper towels to dry them. Dispose of the towels in the yellow disposal bag along with your plastic gloves.

---

A-level Biology example for required practical 5

**Dissection of animal or plant gas exchange or mass transport system or of organ within such a system:**

**Heart dissection**

**Teacher notes**

**Materials**

- a sheep's heart (better if these are obtained from the abattoir than butcher's shop as more of the arteries, veins and atria are likely to be present)
- dissecting tray and board
- dissecting instruments (essentials are scalpel, scissors, mounted needles)
- labels and pins (optical pins work well as they are longer)
- disinfectant in a large beaker and disinfectant spray and paper towels.

**Health and safety**

Lab coats should be worn by all students handling the hearts. Gloves are not necessary, but if used the teacher should ensure that they are removed immediately after the work and disposed of with the paper towels/heart remains.

Ensure cuts to skin are covered with waterproof dressings, and everyone involved in the heart dissection washes their hands thoroughly with bactericidal hand wash after the activity.

- Dissecting instruments are sharp and should be handled with care at all times. Dispose of used instruments into beakers of disinfectant. 1% **VirKon** or 70% IDA/ethanol (for metal instruments) should be used as the disinfectant. All instruments and surfaces used should be washed thoroughly with detergent solution, and only afterwards disinfected if considered necessary. All organic matter should be removed from instruments and surfaces immediately after the dissection.
- Dissected hearts should be carefully wrapped and placed in a bin directly collected by refuse collectors on the day of refuse collection. The hearts should be stored in a freezer (or fridge if only for 2–3 days) until disposal.

This method allows students to explore the organ and its functions rather than follow a strict dissection protocol. Using pins and labels helps the teacher assess whether the student can identify the different sections of heart. Students could use this practical for drawing skills instead of a photograph being taken.

Similar approaches can be used with respiratory system dissections. Rubbing tubing can be inserted into the trachea to inflate the lungs.

**Risk assessment**

Risk assessment and risk management are the responsibility of the centre.

---

## Trialling

The practical should be trialled before use with students.

Photographs of an example set-up of this practical can be found in our set-up guide, which is available on our [A-level practicals page](#).

## Practical 6

Required practical example	Use of aseptic techniques to investigate the effect of antimicrobial substances on microbial growth
<p>The examples show the effects of Dettol on <i>E.coli</i> (K12) bacteria.</p> <p>Other bacteria and antimicrobial substances could be used.</p>	<p><b>Part A:</b> Comparison of the effects of different antimicrobial substances on growth of bacteria in a lawn culture (semi-quantitative).</p> <p><b>Part B:</b> Estimation of the effects of concentration of an antimicrobial substance on growth of bacteria in a lawn culture (semi-quantitative).</p> <p><b>Part C:</b> Investigation of the effects of introducing an antimicrobial substance that is effective in a lawn culture to a population of bacteria in a broth culture (fully quantitative).</p>
<p><b>Apparatus and techniques covered</b></p>	<p><b>Part A:</b></p> <p>AT i. use microbiological aseptic techniques, including the use of agar plates and broth.</p> <p><b>Part B:</b></p> <p>AT i. use microbiological aseptic techniques, including the use of agar plates and broth.</p> <p>ATc.(partial) use of laboratory glassware apparatus for a variety of experimental techniques.</p> <p><b>Part C:</b></p> <p>AT i. use microbiological aseptic techniques, including the use of agar plates and broth.</p> <p>AT c. (partial) use laboratory glassware apparatus to make serial dilutions.</p>
<p><b>Indicative apparatus</b></p> <p><b>* Health and Safety</b></p> <p>Use a pure culture of bacteria that are not considered harmful for people with normal immunity (Containment Level 1).</p> <p><b>** Dilutions of antimicrobial substances</b></p> <p>The dilutions do not need to be prepared under aseptic conditions, as the source antimicrobial substances are not</p>	<p><b>Parts A, B and C:</b></p> <ul style="list-style-type: none"> <li>Working with microbes using aseptic technique.</li> <li>Impervious work surface that can be effectively disinfected. McCartney bottle containing an active broth culture of suitable* bacteria, Bunsen burner, suitable disinfectant (e.g. 1% <i>VirKon</i>), prepared nutrient agar plates, sterile spreader, sterile 1cm<sup>3</sup> Pasteur pipettes, forceps.</li> <li>Antimicrobial substances.</li> <li>Range of household chemicals plant extracts and other materials that are potentially antimicrobial, as appropriate for the planned investigation.</li> </ul> <p><b>Additional apparatus for Parts A and B:</b></p> <p>Filter paper discs (cut with a hole puncher).</p> <p><b>Additional apparatus for Part B:</b></p> <ul style="list-style-type: none"> <li>Obtaining accurate dilutions of antimicrobial substances:**</li> <li>1cm<sup>3</sup> pipette stoppered with non-absorbent cotton wool. Pipette</li> </ul>

<p>sterile and the dilutions do not come into direct contact with microbes.</p> <p>Aseptic preparation using sterile materials is required if the diluted chemicals are to be mixed with a broth culture and then incubated. Contaminant microbes could be pathogenic, so all precautions should be taken to ensure good aseptic technique when preparing cultures. Students should also be familiar with the aseptic technique necessary for safe handling of incubated cultures.</p>	<p>filler. Distilled/deionised water. Boiling tubes preparing and mixing solutions.</p> <p><b>Additional apparatus for Part C:</b></p> <ul style="list-style-type: none"> <li>• Obtaining accurate dilutions of antimicrobial substances:**</li> <li>• Antimicrobial substance diluted using sterile water and aseptic technique to the concentration for testing as decided by the results from method 1 and/or the method planned by the teacher or student.</li> </ul> <p><b>Serial dilutions of microbes:</b></p> <ul style="list-style-type: none"> <li>• 5 sterile screw top bottles, or boiling tubes stoppered with non-absorbent cotton wool, each containing 9cm<sup>3</sup> of sterile nutrient broth.</li> <li>• Sterile 1cm<sup>3</sup> Pasteur pipettes.</li> </ul>
--	---

<p>*students must use microbial cultures and techniques that are not considered hazardous in schools.</p>	Amount of choice			
	Increasing independence			
	Least choice	Some choice	Many choices	Full investigation
	<p>Teacher chooses the microbe and antimicrobial substance(s) to be investigated.</p> <p>Students inoculate agar plates with the microbe and antimicrobial substance(s) (Part A) and measure the outcomes.</p> <p>Experiments fully specified for both equipment and method.</p>	<p>Teacher allows a limited choice of antimicrobial substance(s) for investigation.</p> <p>Students inoculate agar plates with the microbe and selected antimicrobial substance(s) and measure the outcomes.</p> <p>Experiment fully specified (parts A and B), but method may vary in part for different antimicrobials being trialled (eg concentrations).</p>	<p>Teacher allows a choice of antimicrobial substance(s) for testing on a microbe chosen from a *list provided by the teacher.</p> <p>Students select the experimental procedure from a limited range (eg Parts B and/or C), follow that procedure (Part A included) and measure the outcomes.</p>	<p>Student decides on a question relating to the effects of antimicrobial substances on growth of microbes.</p> <p>Student researches methods for carrying out the experiment then chooses *suitable microbes, equipment and materials, justifying all choices.</p>

Opportunities for observation and assessment of competencies				
Follow written procedures	✓✓✓ Students follow written method.	✓✓✓ Students follow written method(s).	✓✓✓ Students follow a method they have chosen.	✓✓✓ Students follow a method they have selected through research.
Applies investigative approaches and methods when using instruments and equipment	✓✓ Students must correctly use the equipment and materials provided.	✓✓ Students must correctly use appropriate equipment and materials from a limited range provided.	✓✓✓ Students must correctly select and use the appropriate equipment, modifying their approach where necessary.	✓✓✓ Students must select an appropriate approach, equipment and techniques and identify correct variables for measurement and control.
Safely uses a range of practical equipment and materials	✓✓ Students must safely use the equipment and aseptic technique.	✓✓ Students must safely use the equipment and aseptic technique.	✓✓ Students minimise risks with minimal prompting.	✓✓✓ Students must carry out a full risk assessment and minimise risks.
Makes and records observations	✓ Students record observations in specified ways.	✓ Students record observations in specified ways.	✓✓ Students record observations in suitable ways.	✓✓✓ Students must select the most effective way of recording observations.
Researches, references and reports	✓ Students compare results with published data and identify reasons for differences.	✓✓ Students compare results with published data and between students and identify reasons for differences.	✓✓ Students compare results with published data and between students and identify reasons for differences.	✓✓✓ Students must research alternatives to plan their work. Reporting covers planning, carrying out and analysing results.

✓✓✓: Very good opportunity ✓✓: Good opportunity ✓: Slight opportunity \*: No opportunity

---

## A-level Biology example for required practical 6

### Procedures

#### **Part A: Comparing the effects of different antimicrobial substances on growth of bacteria in a lawn plate culture (semi-quantitative)**

In this practical, you will wet filter paper discs with a range of chemicals. You may also use discs containing antibiotics. You will use aseptic technique to prepare bacterial lawn cultures, and will place the filter paper and/or antibiotic discs on the bacterial lawn. After incubating the plates, zones of clearing around the discs indicate the effectiveness of each chemical dilution.

### Student sheet

You are provided with the following:

- chinagraph pencil or other marker, or sticky labels
- impervious plastic-coated sheet (A4 size) on which to work. This sheet has been placed in verified disinfectant (*VirKon* is usually used). Immediately before you start the aseptic procedure, remove the sheet from disinfectant, and blot the surface with a paper towel.
- small glass (McCartney) bottle containing a broth culture of bacteria (*E.coli* (K12) is often used)
- Bunsen burner and heat proof mat
- a discard pot (beaker or screw top container containing disinfectant (eg 1% *VirKon*))
- Petri dish containing sterile nutrient agar
- sterile plastic, glass or metal spreader (do not unwrap until point of use)
- sterile plastic or stoppered glass 1cm<sup>3</sup> Pasteur pipette (do not unwrap until point of use)
- rubber/plastic teat to fit glass Pasteur pipette where used
- forceps
- adhesive tape
- Antibiotic multi-test ring containing several antibiotics, or separate antibiotic- containing discs

You should read these instructions carefully before you start work.

### Preparing lawn plate cultures

1. Place the Bunsen burner close to the edge of a heat proof mat and light it (yellow flame).
2. Place the disinfected plastic sheet on the work surface in front of the Bunsen burner.
3. Place the bottle of broth culture, the spreader and pipette next to the Bunsen burner.
4. Write your name, the date and the name of the bacteria on the **underside** of the Petri dish.  
Also divide the base of the plate into sections, and write the name of an antimicrobial for test in each section.
5. Change the airhole on the Bunsen burner, so that it has a hot blue flame.
6. Wash your hands thoroughly using liquid hand-wash/soap. Dry your hands using paper towels.
7. Unwrap a sterile 1cm<sup>3</sup> pipette, and hold it in the air close to the Bunsen flame. If you are using a glass pipette, attach the teat to the pipette.
8. Remove the lid of the McCartney bottle and, without putting the lid down, move the neck of the bottle quickly through the Bunsen flame. This helps to prevent microbes from the air entering.

- 
9. Squeeze the teat of the pipette, place the tip into the broth culture, and release the squeeze on the teat to remove a small volume of the culture (approximately  $0.3\text{cm}^3$ ).
  10. Flame the neck of the bottle and replace the lid.
  11. Lift the lid of the agar plate at an angle facing the Bunsen burner with your non-dominant hand. With your dominant hand, squeeze the teat of the pipette to release 2-3 drops of culture onto the surface of the agar.
  12. Replace the lid of the Petri dish and immediately place the pipette into the discard pot.
  13. Unwrap a sterile spreader.
  14. Take the sterile plastic spreader in your dominant hand. Facing the Bunsen, lift the lid of the agar plate with your non-dominant hand and use the spreader to make sure that the bacteria are evenly spread around the surface of the agar.
  15. Replace the lid of the Petri dish with culture (now called a lawn plate), immediately place the spreader into the discard pot of disinfectant.
  16. Leave the lawn plate for 5-10 minutes, so that the broth is absorbed into the surface of the nutrient agar. Use the lawn plate immediately after this "rest" period.

#### **Placing filter paper discs containing antimicrobial substances**

1. Use forceps to dip filter paper discs into a test solution, so that the disc is wet. Shake the discs to remove drops of moisture before placing them onto the lawn plate culture.  

Students may wish to measure small volumes of solutions onto the discs, using  $1\text{cm}^3$  pipettes or syringes.
2. Use forceps to place the disc with antimicrobial substance onto the bacterial lawn in the appropriate section of the plate.
3. Carefully flatten the Antibiotic multi-test ring or separate discs onto the surface of the plate, using forceps. If the forceps touch the lawn of bacteria on the surface of the agar, place them in the bottle of 70% ethanol provided by the teacher. Forceps that have not touched the bacterial lawn do not require disinfection. Do not place the forceps in *VirKon* disinfectant, as this will cause corrosion.
4. Fasten the lid of the plate in place using two pieces of adhesive tape.
5. Place the plastic-coated work-surface in the tray of *VirKon* disinfectant.
6. Wash your hands thoroughly using liquid hand-wash/soap

Your plate should be placed upside down in an incubator at  $25^\circ\text{C}$  –  $30^\circ\text{C}$  for 24-72 hours, or until zones of inhibition can be clearly seen.



**After incubation:**

**Caution - plates must not be opened after they have been incubated**

The plates below show typical clearing around discs of various chemicals including the antibiotics Streptomycin(S) and Penicillin (P).

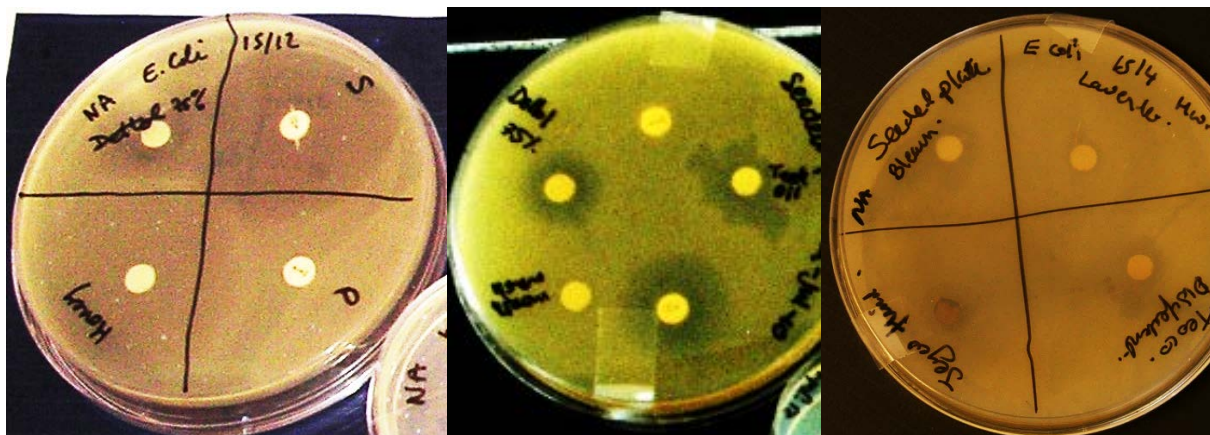

### Plates with antibiotic multi-test rings

Antibiotic multi-test rings have several arms, each arm containing a different anti-bacterial agent. These are usually coded as follows:

Code	Anti-bacterial agent	Code	Anti-bacterial agent
STR	Streptomycin	CHL	Chloramphenicol
SFZ	Sulphafurazole	ERY	Erythromycin
TET	Tetracycline	CXT	Cefoxitin
AMP	Ampicillin	PEN	Penicillin

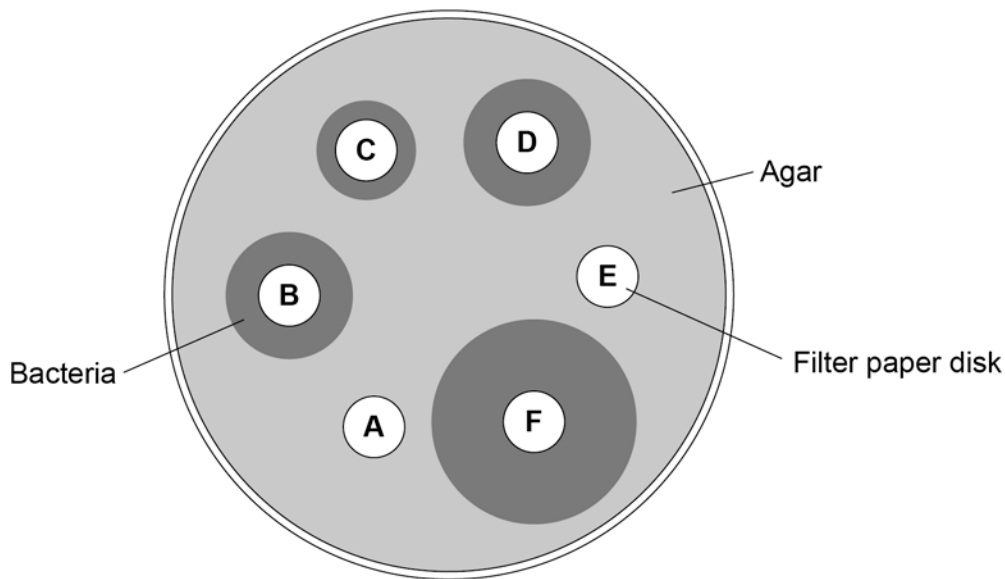

A typical antibiotic multi-test ring plate, showing zones of clearing where bacteria have been inhibited.

These are called **zones of inhibition**.

**Note:**

Gram positive bacteria show sensitivity to different types of antibiotic compared with Gram negative bacteria.

It is important to select the correct type of antibiotic multi-test ring when planning the procedure.

The situation is similar for single antibiotic discs.

**Obtaining data**

With the plate upside down, use a ruler to measure the diameter of the zones of inhibition. Calculate the area of the zone of inhibition using the formula

$$\text{Area of zone} = \pi r^2 \text{ (Use 3.14 as } \pi \text{)}$$

Record your results in a suitable table.

---

## A-level Biology example for required practical 6

### Apparatus and techniques

- Use of laboratory glassware to prepare an accurate range of concentrations of antimicrobial substances (Part B).
- Use of serial dilution followed by making lawn plates to quantify the effects of antimicrobial substances on bacterial populations (Part C).
- Use of aseptic techniques to investigate the effect of antimicrobial substances on growth of bacteria (Part A, Part B and Part C).

### Options for methods

#### **Part A: Comparing the effects of antimicrobial substances on growth of bacteria in a lawn plate culture (semi-quantitative)**

The method allows students to practise working with microbes using aseptic technique. The students compare the effects of filter paper discs containing different chemicals on growth of bacteria in a lawn culture. After incubation, areas of inhibition around each disc indicate the potency of each chemical. Students may also compare the effects of various antibiotic discs on the bacterial lawn.

#### **Part B: Comparing the effects of different concentrations of an antimicrobial substance on growth of bacteria in a lawn plate culture (semi-quantitative)**

Students use laboratory glassware to dilute household and possible new antimicrobial substances. Small volumes of each dilution are used to wet filter paper discs and these are then placed on a bacterial lawn. After incubation, areas of inhibition around each disc indicate the potency of each chemical dilution.

The technique allows students to predict an effective concentration of a trialled chemical, but does not give data about the size of microbial populations.

#### **Part C: Measuring the effects of antimicrobial substances on the growth of bacterial populations in a broth culture (fully quantitative).**

For both Parts A and B, it is possible that the differences in zones of inhibition seen in the bacterial lawns may be due to interaction of the antimicrobial substance with the agar or differences in rate of diffusion.

Part C is subsequently carried out to find out if the chemicals suggested by the Part A and B trials produce a lower growth rate for the microbial population.

The broth cultures used in Part C must be prepared by a teacher or technician, as the culture is incubated following the introduction of the antimicrobial substance.

Students could specify the concentration and volume of the antimicrobial substance to be added, using their conclusions from Parts A and/or B.

The method allows students who are familiar with aseptic technique to make serial dilutions of a broth culture that has been incubated with an antimicrobial substance, and then to make lawn or plate cultures. After incubation, the number of discrete colonies can be counted, and the bacterial population density in the culture calculated. The method is fully quantitative. Antimicrobial

substances are added using excellent aseptic technique to a broth culture that is likely to be in its growth phase, and the serial dilutions take place after further incubation of the culture for 24-36 hours.

Students can select the parameters for treatment of bacterial cultures with antimicrobial substances, allowing a wide range of research-informed investigations to be carried out by students.

### Placing the filter paper discs containing antimicrobial substances

1. Use forceps to place the disc with antimicrobial substance onto the bacterial lawn in the appropriate segment of the plate.
2. Carefully press the disc onto the surface of the plate, using the forceps.
3. If the forceps touch the lawn of bacteria on the surface of the agar, place them in the bottle of 70% ethanol provided by the teacher. Forceps that have not touched the bacterial lawn do not require disinfection. Do not place metal forceps in *VirKon* disinfectant, as this may cause corrosion.
4. Fasten the lid of the plate to the base using two pieces of adhesive tape.
5. Place the plastic coated work surface in the tray of *VirKon* disinfectant.
6. Wash your hands thoroughly using liquid hand-wash/soap.

Your plate should be placed upside down in an incubator at 25°C - 30°C for 24-72 hours, or until zones of clearing can be clearly seen.

### After incubation:

#### Caution – plates must not be opened after they have been incubated.

The plate below shows zones of inhibition for an *E.coli* (K12) lawn around filter paper discs that contained *Dettol*.

The zones of inhibition may contain bacteria, but not in sufficient density to produce a visible lawn.

In this plate, there is little difference between the zones of inhibition produced by 100% *Dettol* compared with 75% *Dettol*. This indicates that the 75% *Dettol* produces the maximum effect.

The results of this experiment suggest that 50% *Dettol* would be the most appropriate for investigating the effects of the antimicrobial substance on populations of bacteria affected by the antimicrobial substance.

75% *Dettol* is more likely to kill all the bacteria.

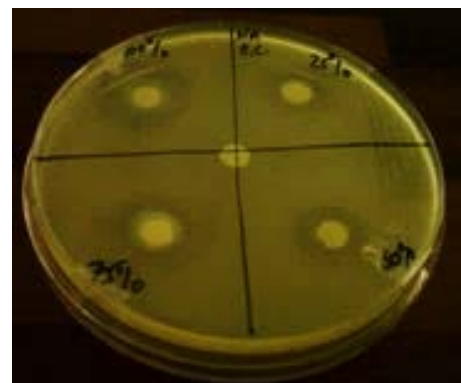

---

### Obtaining data

With the plate upside down, use a ruler to measure the diameter of the zones of inhibition. Calculate the area of the zone of inhibition using the formula.

Area of zone =  $\pi r^2$  (Use 3.14 as  $\pi$ )

Record your results in a suitable table.

### Taking the investigation further

The results from the Part B investigation can be used to suggest volumes and concentrations used to prepare broth cultures for fully quantitative analysis (Part C).

### Volumes suggested for our *E.coli* (K12) with *Dettol* investigation

The ratio of volumes of the area of the filter paper disc compared with the maximum diameter of clearing would suggest a 1 part of antimicrobial substance to 10 parts of bacterial broth culture.

50% *Dettol* would be most likely to give meaningful results.

---

## **Part B: Comparing the effects of different concentrations of antimicrobial substances on growth of bacteria in a lawn plate culture (semi-quantitative)**

In this practical, you will prepare dilutions of antimicrobial substances, and will wet filter paper discs with the chemicals. You will then use aseptic technique to prepare bacterial lawn cultures, and will place the filter paper discs on the bacterial lawn. After incubating the plates, zones of clearing around the discs indicate the effectiveness of each chemical dilution.

### **Student sheet**

You are provided with the following:

Chinagraph pencil or other marker, or sticky labels.

### **Preparing filter paper discs containing chemical dilutions**

- Antimicrobial substance for trialling. This could be a household chemical, plant extract, eg tea-tree oil, or possible novel material. Here, the use of Dettol is described.
- 2x 1cm<sup>3</sup> glass graduated pipettes (one each for water and Dettol).
- Pipette filler.
- Distilled/deionised water (used here), other solvents may be required for other antimicrobial substances.
- Boiling tubes or conical flasks for mixing solutions.
- Filter paper discs made using a hole-punch.

### **Preparing lawn plate cultures and applying discs**

- Impervious plastic-coated sheet (A4 size) on which to work. This sheet has been placed in verified disinfectant (*VirKon* is usually used). Immediately before you start the aseptic procedure, remove the sheet from disinfectant, and blot the surface with a paper towel.
- Small glass (McCartney) bottle containing a broth culture of bacteria (here *E.coli* (K12) is used).
- Bunsen burner and heat proof mat.
- A discard pot (beaker or screw top container containing disinfectant (e.g. 1% *VirKon*)).
- Petri dish containing sterile nutrient agar.
- Sterile plastic, glass or metal spreader (do not unwrap until point of use).
- Sterile plastic or stoppered glass 1cm<sup>3</sup> Pasteur pipette (do not unwrap until point of use).
- Rubber/plastic teat to fit glass Pasteur pipette where used.
- Forceps.
- Adhesive tape.

You should read these instructions carefully before you start work.

### Preparing filter paper discs containing chemical dilutions

1. Use a pipette with filler to place volumes of Dettol and water into boiling tubes, as shown in the table below. The range of effective concentrations will differ for other chemicals and microbes.

Dettol concentration (%)	100	75	50	25	0
Volume Dettol (cm <sup>3</sup> )	10.0	7.5	5.0	2.5	0
Volume water (cm <sup>3</sup> )	0	2.5	5.0	7.5	10

2. Stopper the boiling tubes and agitate the tubes to mix the solutions thoroughly.
3. Use forceps to dip filter paper discs into each solution, so that the disc is wet. Shake the discs to remove drops of moisture before placing them onto the lawn plate culture.
4. Students may wish to measure small volumes of solutions onto the discs, using 1cm<sup>3</sup> pipettes or syringes.

### Preparing lawn plate cultures and applying discs

1. Place the Bunsen burner close to the edge of a heat proof mat and light it (yellow flame).
2. Place the disinfected plastic sheet on the work surface in front of the Bunsen burner.
3. Place the bottle of broth culture, the spreader and pipette next to the Bunsen burner.
4. Write your name, the date and the name of the bacteria on the **underside** of the Petri dish.
5. Also divide the base of the plate into sections, and write the name of an antimicrobial for test in each section.
6. Change the airhole on the Bunsen burner, so that it has a hot blue flame.
7. Wash your hands thoroughly using liquid hand-wash/soap. Dry your hands using paper towels.
8. Unwrap a sterile 1cm<sup>3</sup> pipette, and hold it in the air close to the Bunsen flame. If you are using a glass pipette, attach the teat to the pipette.
9. Remove the lid of the McCartney bottle and, without putting the lid down, move the neck of the bottle quickly through the Bunsen flame. This helps to prevent microbes from the air entering.
10. Squeeze the teat of the pipette, place the tip into the broth culture, and release the squeeze on the teat to remove a small volume of the culture (approximately 0.3cm<sup>3</sup>).
11. Flame the neck of the bottle and replace the lid.
12. Lift the lid of the agar plate at an angle facing the Bunsen burner with your non-dominant hand. With your dominant hand, squeeze the teat of the pipette to release 2-3 drops of broth culture onto the surface of the agar.
13. Replace the lid of the Petri dish and immediately place the pipette into the discard pot.
14. Unwrap a sterile spreader.
15. Take the sterile plastic spreader in your dominant hand. Facing the Bunsen, lift the lid of the agar plate with your non-dominant hand and use the spreader to make sure that the bacteria are evenly spread around the surface of the agar.

- 
16. Replace the lid of the Petri dish with culture (now called a lawn plate), immediately place the spreader into the discard pot of disinfectant.
  17. Leave the lawn plate for 5-10 minutes, so that the broth is absorbed into the surface of the nutrient agar. Use the lawn plate immediately after this “rest” period.



---

## **Part C: Measuring the effects of antimicrobial substances on the growth of bacterial populations in a broth culture (fully quantitative).**

In this practical, you will use aseptic technique to make serial dilutions of a broth culture of bacteria that has been incubated with an antimicrobial substance.

The broth culture will have been prepared by a teacher or technician, using quantities and concentrations based on the results of Part B experiments.

You will then use aseptic technique to prepare bacterial lawn cultures for all of your serial dilutions of the antimicrobial treated broth culture.

After incubating the plates, some of the plates will show discrete colonies. Each colony was a single bacterium on the surface of the agar at the start of incubation. You will count the colonies on the plate, and can then calculate the density of the bacterial population in the culture that has been treated with the antimicrobial substance.

### **Student sheet**

You are provided with the following:

- Chinagraph pencil or other marker, or sticky labels
- impervious plastic-coated sheet (A4 size) on which to work. This sheet has been placed in verified disinfectant (*VirKon* is usually used). Immediately before you start the aseptic procedure, remove the sheet from disinfectant, and blot the surface with a paper towel.

### **For making serial dilutions of the broth culture**

- Small glass (McCartney) bottle containing a broth culture of bacteria (*E.coli* (K12) is often used), that was treated with an antimicrobial substance (here with 50% Dettol, see part B) and then incubated for 24 -72 hours.
- 5x sterile screw top bottles, or boiling tubes stoppered with non-absorbent cotton wool, each containing 9cm<sup>3</sup> of sterile nutrient broth.
- 5x sterile plastic or stoppered glass 1cm<sup>3</sup> Pasteur pipette (do not unwrap until point of use).

Note: If glass Pasteur pipettes are used, a syringe adapter is necessary to accurately measure small volumes. This is a 1ml syringe that has a small piece of tubing attached to the nozzle.

The adapter is placed onto the stoppered end of the glass pipette, and the syringe can then draw up small volumes of broth into the pipette. The volumes are accurate to the smallest gradation on the syringe (e.g. 0.01cm<sup>3</sup>). The syringe adapter does not need to be sterilised before or after use, as the cotton wool stopper in the glass pipette protects the culture from contamination.

### **Preparing quantitative lawn plate cultures**

- 5x McCartney bottles containing serial dilutions of the pre-treated broth culture,
- Bunsen burner, and heat proof mat
- a discard pot (beaker or screw top bottle containing disinfectant (e.g. 1% *VirKon*))
- 5x Petri dishes containing sterile nutrient agar
- 5x sterile plastic, glass or metal spreader (do not unwrap until point of use)
- 5x sterile plastic or stoppered glass 1cm<sup>3</sup> Pasteur pipette (do not unwrap until point of use)
- syringe adapter for use with glass Pasteur pipettes (use of the adapter is described above)
- adhesive tape

You should read the following instructions carefully before you start work.

---

### **Making serial dilutions of the broth culture that was treated with an antimicrobial substance**

1. Place the Bunsen burner close to the edge of a heat proof mat and light it (yellow flame).
2. Place the disinfected plastic sheet on the work surface in front of the Bunsen burner.
3. Place the bottle of broth culture that has been treated with an antimicrobial substance, the pipettes and adapter (if using glass pipettes), and the 5 bottles of broth (dilution series) next to the flame.
4. Label each of the bottles with the date, and the name of the bacterium, and your name.
5. Also label the bottles with the concentrations that will be produced by the serial dilution, for example  $10^{-1}$ ,  $10^{-2}$ ,  $10^{-3}$ ,  $10^{-4}$ ,  $10^{-5}$
6. Change the airhole on the Bunsen burner, so that it has a hot blue flame.
7. Wash your hands thoroughly using liquid hand-wash/soap. Dry your hands using paper towels.
8. Unwrap a sterile  $1\text{cm}^3$  pipette, and hold it in the air close to the Bunsen flame. If you are using a glass pipette, attach the syringe adapter to the pipette.
9. Remove the lid of the treated broth culture bottle and, without putting the lid down, move the neck of the bottle quickly through the Bunsen flame. This helps to prevent microbes from the air entering.
10. Place the tip of the pipette into the broth culture, and use the gradations on the plastic pipette or the syringe adapter to remove  $1\text{cm}^3$  of the culture.
11. Flame the neck of the bottle and replace the lid.
12. Remove the lid of the  $10^{-1}$  dilution series bottle and, without putting the lid down, move the neck of the bottle quickly through the Bunsen flame. This helps to prevent microbes from the air entering.
13. Place the tip of the pipette into the dilution series bottle and use the teat of the pipette or the plunger of the syringe adapter to place the contents of the pipette into the bottle.
14. Place the pipette immediately into the discard pot (containing 1% *VirKon*).
15. Flame the mouth of the  $10^{-1}$  bottle, and replace its lid. Agitate the bottle to mix the contents.
16. Repeat the dilution procedure to transfer  $1\text{cm}^3$  of the  $10^{-1}$  dilution into the  $10^{-2}$  dilution bottle.
17. Repeat the procedure to transfer  $1\text{cm}^3$  from the  $10^{-2}$  bottle into the  $10^{-3}$  bottle, and then continue the procedure until all the bottles in dilution series have been inoculated.

### **Preparing lawn plate cultures**

1. Place a bottle of serially diluted broth culture, the spreader and pipette next to the Bunsen burner.
2. Write your name, the date, the name of the bacteria and the serial dilution of the broth on the underside of the Petri dish.
3. Change the airhole on the Bunsen burner, so that it has a hot blue flame (roaring).
4. Wash your hands thoroughly using liquid hand-wash/soap. Dry your hands using paper towels.
5. Unwrap a sterile  $1\text{cm}^3$  pipette, and hold it in the air close to the Bunsen flame. If you are using a glass pipette, attach the syringe adapter to the pipette.

6. Remove the lid of the McCartney bottle and, without putting the lid down, move the neck of the bottle quickly through the Bunsen flame. This helps to prevent microbes from the air entering.
7. Place the tip of the pipette into the broth culture, and use the gradations on the plastic pipette or the syringe adapter to remove  $0.3\text{cm}^3$  of the culture.
8. Flame the neck of the bottle and replace the lid.
9. Lift the lid of the agar plate at an angle facing the Bunsen burner with your non-dominant hand. With your dominant hand, use the teat of the plastic pipette or the plunger of the syringe adapter to release the measured volume of broth culture onto the surface of the agar.
10. Replace the lid of the Petri dish and immediately place the pipette into the discard pot.
11. Unwrap a sterile spreader.
12. Take the sterile plastic spreader in your dominant hand. Facing the Bunsen, lift the lid of the agar plate with your non-dominant hand and use the spreader to make sure that the bacteria are evenly spread around the surface of the agar.
13. Replace the lid of the Petri dish with culture (now called a lawn plate), immediately place the spreader into the discard pot of disinfectant.
14. Repeat the procedure for the other bottles of the dilution series.
15. Leave the lawn plate for 5-10 minutes, so that the broth is absorbed into the surface of the agar.
16. Fasten the lid of the plate in place using two pieces of adhesive tape.
17. Place the plastic coated work surface in the tray of *VirKon* disinfectant.
18. Wash your hands thoroughly using liquid hand-wash/soap.

Your plate should be placed upside down in an incubator at  $25^{\circ}\text{C}$  –  $30^{\circ}\text{C}$  for 24-72 hours, or until colonies can be clearly seen.

#### After incubation:

#### Caution - plates must not be opened after they have been incubated

The plates below show typical results from two bottles of a serial dilution of a broth culture

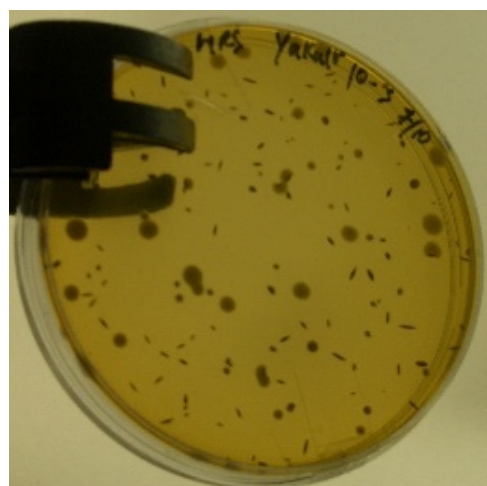
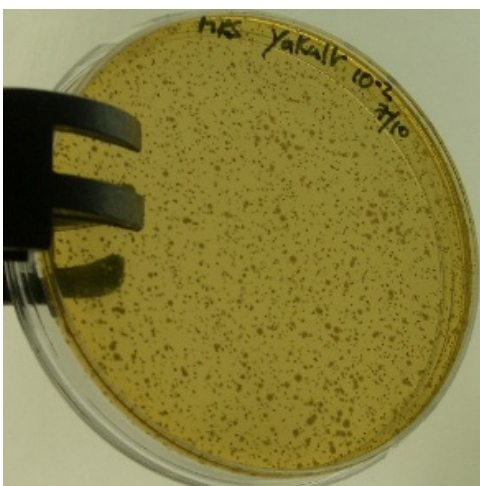

---

### **Obtaining data**

Choose a plate that shows a suitable number of non-overlapping colonies, and estimate the number of colonies on the plate.

As each colony indicates one initial bacterium, calculate the density of bacteria/cm<sup>3</sup> in the broth used to inoculate the plate.

Then calculate the population density of bacteria in the treated broth culture.

The population density of untreated broth culture should also be estimated, so that the effects of the antimicrobial substance can be seen.

The activity could be extended if each group in a class carried out serial dilution of broth cultures that had been pre-treated differently.

### **Potential for investigations**

A wide range of different parameters could be investigated, for example:

- species of bacterium
- type of antimicrobial substance
- concentration and volume
- timing of introduction of antimicrobial in relation to the “age” of the initial broth culture
- addition of more than one antimicrobial substance to the broth culture.

---

## A-level Biology example for required practical 6

### Teachers' and technicians' notes

The three parts of this required practical develop distinct aspects:

- Part A: for development and evidencing of safe and effective practice in working with microbes
- Part B: for development and evidencing of techniques for using standard laboratory glassware to obtain accurate concentrations
- Part C: for development and evidencing of serial dilution techniques, to enable very low concentrations of bacterial cultures to be made with precision. The bacterial populations in the serially diluted cultures are low, and therefore can be counted easily by students.

### Part A: Developing aseptic techniques, and comparing a range of antimicrobial substances

#### Student equipment and materials

- Chinagraph pencil or other marker, or sticky labels
- Impervious plastic-coated sheet (A4 size) on which to work. This sheet has been placed in verified disinfectant (*VirKon* is usually used). Immediately before you start the aseptic procedure, remove the sheet from disinfectant, and blot the surface with a paper towel
- Small glass (McCartney) bottle containing a broth culture of bacteria (here *E.coli* (K12) is used)
- Bunsen burner and heat proof mat
- A discard pot (beaker or screw top bottle containing disinfectant (e.g. 1% *VirKon*))
- Petri dish containing sterile nutrient agar
- Sterile plastic, glass or metal spreader (do not unwrap until point of use)
- Sterile plastic or stoppered glass 1cm<sup>3</sup> Pasteur pipette (do not unwrap until point of use)
- Rubber/plastic teat to fit glass Pasteur pipette where used
- Forceps
- Adhesive tape
- Antibiotic multi-test ring containing several antibiotics, or separate antibiotic- containing discs.

#### Materials

- Students should work on a surface that has been placed in 1% *VirKon* for at least 10 minutes before the practical. A laminated piece of paper, plastic sheet or a ceramic/glass tile could be used as the surface and this should be placed in a tray/bowl of *VirKon* for at least 10 minutes before the activity.
- McCartney bottle containing bacteria in nutrient broth. Bacteria that are not considered hazardous for people with normal immunity should be used. Examples of suitable bacteria include *Bacillus subtilis*, *Bacillus megaterium* (G+), *E.coli* K12 strain(G-), *E.coli* B strain(G-), *Micrococcus luteus* (G+). Consult CLEAPSS/SSERC for guidance if necessary.
- It is also important to select microbes that grow well in nutrient broth, and do not require incubation at temperatures above 30°C.

The broth culture should be prepared aseptically by a suitably trained teacher or technician, and incubated at 25-30°C until bacterial growth can be seen (the broth becomes cloudy or clumps are seen). The cultures should be used very soon after growth has become visible.

---

Broth cultures used by each student group should be sterilised shortly after use by steam at 121°C for 15 minutes.

In this practical students practise aseptic technique to produce a bacterial lawn and then use filter paper discs containing different antimicrobial substances, discs containing single antibiotics or antibiotic multi-test rings that have 6-8 antibiotics to compare the bacterial sensitivity.

The aseptic techniques must be fully demonstrated to students before they carry out the investigation.

**The bacterial culture must be of a microbe not considered hazardous and must be prepared using very good aseptic techniques that will ensure that it has not been contaminated with environmental microbes.**

## Technical information

### Broth culture of bacteria

Add 13g nutrient broth powder to 1 dm<sup>3</sup> distilled water. Stir well and distribute into McCartney bottles – approximately 10cm<sup>3</sup> per bottle. Sterilise with steam in an autoclave or sterilising pressure cooker at 121°C for 15 minutes. Once cooled introduce an inoculating loop of bacteria from a slope and incubate at 25-30°C, until the broth appears cloudy, or clumps of bacteria appear. Bacteria vary in growth rate, the growth should be evident in 1-3 days.

### Petri dishes with sterile nutrient agar

Add 28g nutrient agar powder to 1 dm<sup>3</sup> distilled water in a large beaker. Heat in the microwave (stirring the mixture at frequent intervals) until it boils and looks completely transparent (this can be done on a hot plate, stirring continuously to prevent burning). Pour into glass bottles or flasks that can withstand autoclaving, stopper with non-absorbent cotton wool or a screw cap and sterilise with steam at 121°C for 15 minutes, using an autoclave or sterilising pressure cooker. Ensure that the bottles/flasks are no more than  $\frac{3}{4}$  filled, to allow room for the agar to expand during heating. Allow to cool to 50°C before pouring into sterile 9cm diameter Petri dishes, using aseptic technique. Each agar plate will require 12-15cm<sup>3</sup> of agar.

If the agar solidifies before being poured, melt it again by heating it to about 90°C, using a boiling water bath, a pressure cooker or using a microwave. Take care to prevent the agar boiling out of the bottles.

The nutrient agar plates can be made several days in advance of the practical, and they keep well if wrapped in cling film and stored upside down. Inspect the stored plates before use by students, and sterilise any that show signs of contamination. Do not use any plates in which the agar has shrunk away from the edges of the plate.

- All inoculated or contaminated broths and agar plates must be **sterilised by steam at 121°C for 15 minutes** in an autoclave or sterilising pressure cooker before disposal.
- Students should return their plastic-coated work-surface to the bowl/tray of 1% *VirKon* after the activity.
- All pipettes should be filled with 1% *VirKon* immediately after use.

---

## Additional information

Sterile plastic Pasteur pipettes (1ml) and spreaders can be obtained from suppliers. These must be placed in 1% *VirKon* (for 10 minutes) immediately after use, and cannot be used again as sterile equipment.

For sterilising glass pipettes and glass or metal spreaders, wrap the equipment in foil or paper and heat in an oven at 180°C for 30 minutes. These must be placed in 1% *VirKon* (for 10 minutes) after use, and can be re-sterilised for re-use.

For small classes, glass spreaders can be sterilised in 70% ethanol and flamed before use.

The ethanol is placed in a shallow beaker so it just covers the base and an airtight lid is put over the beaker. This is kept well away from flames (at least 1m) and kept covered. The spreader is placed in the ethanol for 5 minutes, removed and excess ethanol allowed to drip into the beaker. The spreader is then passed through a Bunsen flame so that the ethanol burns off. The spreader must be held close to the Bunsen flame to cool to room temperature before it is used.

The used spreader can be re-sterilised by placing in 70% ethanol flaming and cooling and then used by another student.

Please also note that the spreader should be cooled fully before use, and before placing in the ethanol beaker. Glass spreaders may take several minutes to cool sufficiently.

For large quantities of plates, sterile nutrient agar can be made in autoclavable bottles with screw caps which are available from most suppliers. Allow approximately 15ml of agar per plate required when preparing the agar. Sterilise with the caps loose on each bottle, and once sterilised, screw the cap tightly. The bottles can be stored for several months or longer, as long as they do not show signs of deterioration. The agar should be melted before use as described previously.

Gram positive bacteria (*Bacillus* sp.) give different results to gram negative bacteria (*E. coli* K12). *Bacillus* sp. tend to produce a denser growth on the plates but take 48 hours to show evidence of a lawn, whereas *E. coli* plates need to be checked after 24 hours to prevent overgrowth. Plates can be put in the fridge for a few days before zones are measured to prevent loss of results.

Students may initially have problems preparing confluent lawns for this practical. Some practice of aseptic techniques and preparing lawns is required before attempting this practical so students can see what a good confluent lawn looks like when prepared correctly. Alternatively, lawns used for the antimicrobial test could be prepared by technicians immediately before the lesson so that students have a two-stage practical: preparing lawns and using antimicrobial disks, so that all students get a suitable plate on which to measure zones of inhibition.

---

## Part B: Development of skills for using standard laboratory glassware and comparing effects of different concentrations of antimicrobial substances on growth of bacteria

### Student equipment and materials

- Chinagraph pencil or other marker, or sticky labels

### Preparing filter paper discs containing chemical dilutions

#### Materials

- Antimicrobial substance for trialling. This could be a household chemical, plant extract (e.g. tea or possible novel material. Here, the use of Dettol is described.
- 2x 1cm<sup>3</sup> glass graduated pipettes (one each for water and Dettol)
- Pipette filler
- Distilled/deionised water (used here), other solvents may be required for other antimicrobial substances.
- Boiling tubes or conical flasks for mixing solutions
- Filter paper discs made using a hole punch.

### Preparing lawn plate cultures and applying discs

#### Materials

- Impervious plastic-coated sheet (A4 size) on which to work. This sheet has been placed in verified disinfectant (*VirKon* is usually used). Immediately before you start the aseptic procedure, remove the sheet from disinfectant, and blot the surface with a paper towel.
- Small glass (McCartney) bottle containing a broth culture of bacteria (here *E.coli* (K12) is used)
- Bunsen burner and heat proof mat
- A discard pot (beaker or screw top container containing disinfectant (e.g. 1% *VirKon*))
- Petri dish containing sterile nutrient agar
- Sterile plastic, glass or metal spreader (do not unwrap until point of use)
- Sterile plastic or stoppered glass 1cm<sup>3</sup> Pasteur pipette (do not unwrap until point of use)
- Rubber/plastic teat to fit glass Pasteur pipette where used
- Forceps
- Adhesive tape.

#### Materials

- Students should work on a surface that has been placed in 1% *VirKon* for at least 10 minutes before the practical. A laminated piece of paper, plastic sheet or a ceramic/glass tile could be used as the surface and this should be placed in a tray/bowl of *VirKon* for at least 10 minutes before the activity.
- McCartney bottle containing bacteria in nutrient broth. Bacteria that are not considered hazardous for people with normal immunity should be used. Examples of suitable bacteria include *Bacillus subtilis*, *Bacillus megaterium* (G+), *E.coli* K12 strain(G-), *E.coli* B strain(G-), *Micrococcus luteus* (G+). Consult CLEAPSS/SSERC for guidance if necessary.
- Gram positive (G+) and gram negative (G-) bacteria are sensitive to different types of antibiotic. Ensure that this is taken into account when ordering antibiotic discs, Multodisks and bacterial cultures.
- It is also important to select microbes that grow well in nutrient broth, and do not require incubation at temperatures above 30°C.



---

The broth culture should be prepared aseptically by a suitably trained teacher or technician, and incubated at 25-30°C until bacterial growth can be seen (the broth becomes cloudy or clumps are seen). The cultures should be used very soon after growth has become visible.

Broth cultures used by each student group should be sterilised shortly after use by steam at 121°C for 15 minutes.

In this practical students practise aseptic technique to produce a bacterial lawn and then use filter paper discs containing different concentrations of antimicrobial substances to compare the bacterial sensitivity.

The aseptic techniques must be fully demonstrated to students before they carry out the investigation.

**The bacterial culture must be of a microbe not considered hazardous and must be prepared using very good aseptic techniques that will ensure that it has not been contaminated with environmental microbes.**

## Technical information

### Broth culture of bacteria

Add 13g nutrient broth powder to 1 dm<sup>3</sup> distilled water. Stir well and distribute into McCartney bottles – approximately 10cm<sup>3</sup> per bottle. Sterilise with steam in an autoclave or sterilising pressure cooker at 121°C for 15 minutes. Once cooled introduce an inoculating loop of bacteria from a slope and incubate at 25-30°C, until the broth appears cloudy, or clumps of bacteria appear. Bacteria vary in growth rate; the growth should be evident in 1-3 days.

### Petri dishes with sterile nutrient agar

Add 28g nutrient agar powder to 1 dm<sup>3</sup> distilled water in a large beaker. Heat in the microwave until it boils and looks completely transparent (this can be done on a hot plate, stirring continuously to prevent burning). Pour into glass bottles or flasks that can withstand autoclaving, stopper with non-absorbent cotton wool or a screw cap and sterilise with steam at 121°C for 15 minutes, using an autoclave or sterilising pressure cooker. Ensure that the bottles/flasks are no more than  $\frac{3}{4}$  filled, to allow room for the agar to expand during heating. Allow to cool to 50°C before pouring into sterile 9cm diameter Petri dishes, using aseptic technique. Each agar plate will require 12-15cm<sup>3</sup> of agar.

If the agar solidifies before being poured, melt it again by heating it to about 90°C, using a boiling water bath, a pressure cooker or using a microwave taking care to prevent the agar boiling out of the bottles.

The nutrient agar plates can be made several days in advance of the practical, and keep well if wrapped in cling film and stored upside down. Inspect the stored plates before use by students, and sterilise any that show signs of contamination. Do not use any plates in which the agar has shrunk away from the edges of the plate.

- Broths and agar plates must be **sterilised by steam at 121°C for 15 minutes** in an autoclave or sterilising pressure cooker before disposal.
- Students should return their plastic-coated work-surface to the bowl/tray of 1% *VirKon* after the activity.
- All pipettes should be filled with 1% *VirKon* immediately after use.

---

## Additional information

Sterile plastic Pasteur pipettes (1ml) and spreaders can be obtained from suppliers. These must be placed in 1% *VirKon* (for 10 minutes) immediately after use, and cannot be used again as sterile equipment.

For sterilising glass pipettes and glass or metal spreaders, wrap the equipment in foil or paper and heat in an oven at 180°C for 30 minutes. These must be placed in 1% *VirKon* (for 10 minutes) after use, and can be re-sterilised for re-use.

For small classes, glass spreaders can be sterilised in 70% ethanol and flamed before use.

The ethanol is placed in a shallow beaker so it just covers the base and a secure lid is put over the beaker. This is kept well away from flames (at least 1m) and kept covered. The spreader is placed in the ethanol for five minutes, removed, and excess ethanol allowed to drip into the beaker. The spreader is then passed through a Bunsen flame so that the ethanol burns off. The spreader must be held close to the Bunsen flame to cool to room temperature before it is used.

The sterilised spreader can be re-sterilised by placing in 70% ethanol flaming and cooling and then used by another student.

Please also note that the spreader should be cooled fully before use, and before placing in the ethanol beaker. Glass spreaders may take several minutes to cool sufficiently.

For large quantities of plates, sterile nutrient agar can be made in autoclavable bottles with screw caps which are available from most suppliers. Allow approximately 15ml of agar per plate required when preparing the agar. Sterilise with the caps loose on each bottle, and once sterilised, screw the cap tightly. The bottles can be stored for several months or longer, as long as they do not show signs of deterioration. The agar should be melted before use as described earlier.

Gram positive bacteria (*Bacillus* sp.) give different results to gram negative bacteria (*E. coli* K12). *Bacillus* sp. tend to produce a denser growth on the plates but take 48 hours whereas to show a visible lawn, *E. coli* plates need to be checked after 24 hours to prevent overgrowth. Plates can be put in the fridge for a few days before zones are measured to prevent loss of results.

Students may initially have problems preparing confluent lawns for this practical. Some practice of aseptic techniques and preparing lawns is required before attempting this practical so students can see what a good confluent lawn looks like when prepared correctly. Alternatively, lawns used for the antimicrobial test could be prepared by technicians immediately before the lesson so that students have a two-stage practical: preparing lawns and using antimicrobial disks, so that all students get a suitable plate on which to measure zones of inhibition.

The pipettes, boiling tubes and flasks used to make the different concentrations of antimicrobial substances do not need to be sterilised, as the prepared chemicals are not mixed with a broth culture.

---

## Part C: Development of skills for making serial dilutions of broth cultures to quantify the effect of different concentrations of antimicrobial substances on growth of bacteria

### Student equipment and materials

- Chinagraph pencil or other marker, or sticky labels.
- Impervious plastic-coated sheet (A4 size) on which to work. This sheet has been placed in verified disinfectant (*VirKon* is usually used). Immediately before you start the aseptic procedure, remove the sheet from disinfectant, and blot the surface with a paper towel.

### For making serial dilutions of the broth culture

#### Materials

- Small glass (McCartney) bottle containing a broth culture of bacteria (here *E.coli* (K12) is used), that was treated with an antimicrobial substance (here with 50% Dettol, see part B) and then incubated for 24-72 hours.
- 5x sterile screw top bottles, or boiling tubes stoppered with non-absorbent cotton wool, each containing 9cm<sup>3</sup> of sterile nutrient broth.
- 5x Sterile plastic or stoppered glass 1cm<sup>3</sup> Pasteur pipette (do not unwrap until point of use).

Note: If glass Pasteur pipettes are used, a syringe adapter is necessary to accurately measure small volumes. This is a 1ml syringe that has a small piece of tubing attached to the nozzle.

The adapter is placed onto the stoppered end of the glass pipette, and the syringe can then draw up small volumes of broth into the pipette. The volumes are accurate to the smallest gradation on the syringe (e.g. 0.01cm<sup>3</sup>). The syringe adapter does not need to be sterilised before or after use, as the cotton wool stopper in the glass pipette protects the culture from contamination.

### Preparing quantitative lawn plate cultures

#### Materials

- 5x McCartney bottles containing serial dilutions of the pre-treated broth culture
- Bunsen burner and heat proof mat
- A discard pot (beaker or screw top bottle containing disinfectant (e.g. 1% *VirKon*))
- 5x Petri dishes containing sterile nutrient agar
- 5x Sterile plastic, glass or metal spreader (do not unwrap until point of use)
- 5x Sterile plastic or stoppered glass 1cm<sup>3</sup> Pasteur pipette (do not unwrap until point of use)
- Syringe adapter for use with glass Pasteur pipettes (use of the adapter is described above)
- Adhesive tape.

#### Materials

- Students should work on a surface that has been placed in 1% *VirKon* for at least 10 minutes before the practical. A laminated piece of paper, plastic sheet or a ceramic/glass tile could be used as the surface and this should be placed in a tray/bowl of *VirKon* for at least 10 minutes before the activity.
- McCartney bottle containing bacteria in nutrient broth. Bacteria that are not considered hazardous for people with normal immunity should be used. Examples of suitable bacteria include *Bacillus subtilis*, *Bacillus megaterium* (G+), *E.coli* K12 strain(G-), *E.coli* B strain(G-), *Micrococcus luteus* (G+). Consult CLEAPSS/SSERC for guidance if necessary.
- It is also important to select microbes that grow well in nutrient broth, and do not require incubation at temperatures above 30°C.

---

The broth culture should be prepared aseptically by a suitably trained teacher or technician, and incubated at 25-30°C until bacterial growth can be seen (the broth becomes cloudy or clumps are seen). The cultures should be used very soon after growth has become visible.

A suitably trained teacher or technician should then use aseptic technique to add the specified volume and concentration of antimicrobial chemical to the broth culture (see the guidelines below).

At least one control bottle of broth should be prepared and incubated alongside the treated broths. For the control broth, a volume of sterile water equal to the volume of antimicrobial substance should be added to the broth culture.

The broth(s) with antimicrobial substance (s) should be then incubated at 25°-30°C for 1-2 days, and then distributed to student groups. The control broth(s) should be similarly incubated and distributed.

Broth cultures used by each student group should be sterilised shortly after use by steam at 121°C for 15 minutes.

In this practical, students use aseptic technique to make serial dilutions of the broth that has been treated, and subsequently make bacterial lawn cultures for each dilution. After the plates have been incubated, the students count the colonies on one or more plates, and then calculate the population density of the bacteria in the control and treated broths.

The students should have practised aseptic techniques before the practical, and the serial dilution must be fully demonstrated before they carry out the investigation.

**The bacterial culture must be of a microbe not considered hazardous and must be prepared using excellent aseptic techniques that will ensure that it has not been contaminated with environmental microbes.**

## Technical information

### Initial broth culture of bacteria

Add 13g nutrient broth powder to 1 dm<sup>3</sup> distilled water. Stir well and distribute into McCartney bottles –10cm<sup>3</sup> per bottle. Sterilise with steam in an autoclave or sterilising pressure cooker at 121°C for 15 minutes. Once cooled introduce an inoculating loop of bacteria from a slope and incubate at 25-30°C, until the broth appears cloudy, or clumps of bacteria appear. Bacteria vary in growth rate, the growth should be evident in 1-3 days.

### Treating the initial culture with antimicrobial substance

The teacher and/or students will give details of the volume and concentration that they wish to test. (For example, 1cm<sup>3</sup> of Dettol diluted to a 50% concentration using sterile distilled water, to be added to 9cm<sup>3</sup> of *E.coli* (K12) broth culture that has been incubated at 25°C for 24 hours).

Ensure that the antimicrobial substance is diluted using sterile water and equipment into a sterile McCartney bottle. For a 50% Dettol solution, place 5cm<sup>3</sup> of water in a McCartney bottle and sterilise with steam in an autoclave or sterilising pressure cooker at 121°C for 15 minutes.

When cool, use aseptic technique and a sterile pipette or syringe to add 5cm<sup>3</sup> of Dettol to the bottle and mix well.

Use aseptic technique and a sterile pipette or syringe to add 1cm<sup>3</sup> to the initial broth culture.

---

**The treated culture is incubated before and after introduction of the antimicrobial substances, and students will open the culture to make serial dilutions.**

**The risks of contamination with environmental microbes mean that the treated cultures must be prepared by a suitably trained teacher or technician using excellent aseptic technique.**

### **Nutrient broth bottles for serial dilution**

Add 13g nutrient broth powder to 1 dm<sup>3</sup> distilled water. Stir well and distribute into McCartney bottles –9cm<sup>3</sup> per bottle. Sterilise with steam in an autoclave or sterilising pressure cooker at 121°C for 15 minutes. After cooling, ensure that the lids are firmly in place, and provide five bottles for each student group.

### **Petri dishes with sterile nutrient agar**

Add 28g nutrient agar powder to 1dm<sup>3</sup> distilled water in a large beaker. Heat in the microwave “(with frequent stirring) until it boils and looks completely transparent (this can be done on a hot plate, stirring continuously to prevent burning). Pour into glass bottles or flasks that can withstand autoclaving, stopper with non-absorbent cotton wool or a screw cap and sterilise with steam at 121°C for 15 minutes, using an autoclave or sterilising pressure cooker. Ensure that the bottles/flasks are no more than  $\frac{3}{4}$  filled, to allow room for the agar to expand during heating. Allow to cool to 50°C before pouring into sterile 9cm diameter Petri dishes, using aseptic technique. Each agar plate will require 12-15cm<sup>3</sup> of agar.

If the agar solidifies before being poured, melt it again by heating it to about 90°C, using a boiling water bath, a pressure cooker or using a microwave taking care to prevent the agar boiling out of the bottles. Take care when handling hot agar.

The nutrient agar plates can be made several days in advance of the practical and these keep well if wrapped in cling film and stored upside down. Inspect the stored plates before use by students, and sterilise any that show signs of contamination. Do not use any plates in which the agar has shrunk away from the edges of the plate.

- Inoculated broths and agar plates must be **sterilised by steam at 121°C for 15 minutes** in an autoclave or sterilising pressure cooker before disposal.
- Students should return their plastic-coated work-surface to the bowl/tray of 1% *VirKon* after the activity.
- All pipettes should be filled with 1% *VirKon* immediately after use.

---

## Additional information

Sterile plastic Pasteur pipettes (1ml) and spreaders can be obtained from suppliers. These must be placed in 1% *VirKon* (for 10 minutes) immediately after use, and cannot be used again as sterile equipment.

For sterilising glass pipettes and glass or metal spreaders, wrap the equipment in foil or paper and heat in an oven at 180°C for 30 minutes. These must be placed in 1% *VirKon* (for 10 minutes) after use, and can be re-sterilised for re-use.

For small classes, glass spreaders can be sterilised in 70% ethanol and flamed before use. The ethanol is placed in a shallow beaker so it just covers the base and a lid is put over the beaker. This is kept well away from flames (at least 1m) and kept covered. The spreader is placed in the ethanol for five minutes, removed and excess ethanol allowed to drip into the beaker. The spreader is then passed through a Bunsen flame so that the ethanol burns off. The spreader must be held close to the Bunsen flame to cool to room temperature before it is used. The sterilised spreader can be re-sterilised by placing in 70% ethanol flamed and cooled and then used by another student.

Please also note that the spreader should be cooled fully before use, and before placing in the ethanol beaker. Glass spreaders may take several minutes to cool sufficiently.

For large quantities of plates, sterile nutrient agar can be made in autoclavable bottles with screw caps which are available from most suppliers. Allow approximately 15cm<sup>3</sup> of agar per plate required when preparing the agar. Sterilise with the caps loose on each bottle, and once sterilised, screw the cap tightly. The bottles can be stored for several months or longer, as long as they do not show signs of deterioration. The agar should be melted before use as described earlier.

The students will be carrying out a fully quantitative investigation and use sterile equipment and aseptic technique. For measuring small volumes of liquids aseptically students should use either sterile 1cm<sup>3</sup> plastic Pasteur pipettes or sterile 1cm<sup>3</sup> glass Pasteur pipettes. To measure small volumes of liquid into the glass pipettes, attach the plugged end of the pipette to a 1cm<sup>3</sup> syringe with a small piece of silicon or rubber tubing. When the syringe plunger is used to measure the required volume, this volume of liquid will be drawn into the sterile glass pipette. Students should practise measuring small volumes using non-sterile equipment so that they become confident before carrying out the procedure aseptically.

## Risk assessment

Risk assessment and risk management are the responsibility of the centre.

## Trialling

The practicals should be trialled before use with students.

## Practical 7

<b>Required practical</b>	<b>Use of chromatography to investigate the pigments isolated from leaves of different plants eg leaves from shade-tolerant and shade-intolerant plants or leaves of different colours</b>			
<b>Apparatus and techniques covered</b> (Not full statements)	AT c. use laboratory glassware apparatus for a variety of experimental techniques AT g. separate biological compounds using thin layer/paper chromatography			
<b>Indicative apparatus and materials</b>	Suitable leaves, chromatography paper (or TLC sheets), suitable solvent, glass rod, boiling tube and bung.			
	<b>Amount of choice</b>			
	<b>Increasing independence</b> 			
	Least choice	Some choice	Many choices	Full investigation
	Teacher chooses the type of leaf and solvent to be used. Students set up chromatograms using extracts from the leaves. Students could calculate Rf values for pigments from each leaf. Experiments fully specified in terms of equipment and method.	Teacher allows a limited choice of type of leaf to use. Students set up chromatograms using extracts from the leaves. Students could calculate Rf values for pigments from each leaf. Experiment probably fully specified by teacher.	Teacher allows a choice of type of leaf to use and a choice of solvents. Students set up chromatograms using extracts from the chosen leaves, using chosen solvent. Students measure Rf values for pigments from each leaf. Outline procedure and equipment provided by teacher.	Student decides on a question. Student researches methods for carrying out the experiment then chooses equipment, materials, justifying all choices.
<b>Opportunities for observation and assessment of competencies</b>				
Follow written procedures	✓✓✓ Students follow written method.	✓✓✓ Students follow written method.	✓✓ Students follow an outline method.	✓✓✓ Students follow a method they have researched.
Applies investigative approaches and methods when using instruments	✓ Students must correctly use the appropriate equipment.	✓ Students must correctly use the appropriate equipment.	✓✓ Students must correctly use the appropriate equipment.	✓✓✓ Students must choose an appropriate approach, equipment and techniques and identify correct

and equipment				variables for measurement and control.
Safely uses a range of practical equipment and materials	✓✓ Students must safely use the equipment.	✓✓ Students must safely use the equipment.	✓✓ Students minimise risks with minimal prompting.	✓✓✓ Students must carry out a full risk assessment and minimise risks.
Makes and records observations	✓ Students make measurements to calculate Rf values.	✓ Students make measurements to calculate Rf values.	✓ Students make measurements to calculate Rf values.	✓✓✓ Students must choose the most effective way of recording observations.
Researches, references and reports	✓ Students compare results with published Rf values for that solvent and identify reasons for differences.	✓✓ Students compare results with published Rf for that solvent values and between students and identify reasons for differences.	✓✓ Students compare results with published Rf values for that solvent and between students and identify reasons for differences.	✓✓✓ Students must research alternatives in order to plan their work. Reporting covers the planning, carrying out and an analysis of their results using comparisons with published Rf values.

✓✓✓: Very good opportunity ✓✓: Good opportunity ✓: Slight opportunity ✕: No opportunity



---

## A-level Biology example for required practical 7

### Use of chromatography to investigate the pigments isolated from leaves of different plants eg leaves from shade-tolerant and shade-intolerant plants or leaves of different colours:

#### An investigation of pigments present in leaves

### Student sheet

#### Introduction

In plants, chlorophyll is the main pigment that absorbs light during photosynthesis. Most plants have other photosynthetic pigments as well and these are not green. You will be using a technique called chromatography to separate chlorophyll and other pigments from two different leaves, A and B.

#### Method

You are provided with the following:

- boiling-tube rack
- two boiling tubes with bungs
- small glass measuring cylinder
- solvent
- chromatography paper
- glass rod
- two leaves, A and B
- cork borer
- tile on which to use cork borer
- ruler
- pencil
- drawing pins
- marker pen
- sticky tape.

#### Safety

Wear eye protection and work in a well-ventilated room or fume cupboard.

You should read these instructions carefully before you start work.

1. Set up two boiling tubes at the start of the investigation. Add 3cm<sup>3</sup> of solvent to each of the two boiling tubes. Put a bung in the top of each tube and stand them upright in a rack. Label the tubes A and B.
2. Take a piece of chromatography paper that fits into the boiling tube, as shown in the diagram. Rule a pencil line 2cm from the bottom of the filter paper. This line is called the origin. Write leaf A at the top of the chromatography paper in pencil.
3. Cut a disc from leaf A with a cork borer. Avoid the veins and midrib of the leaf when you do this.
4. Place the leaf disc on the chromatography paper at the centre of the line marking the origin. Crush the disc into the paper with the end of a glass rod. The crushed leaf disc should leave a stain on the chromatography paper.
5. Pin the chromatography paper to the bung with a drawing pin, and then put the chromatography paper into the tube labelled A as shown in **Figure 1**. Make sure the end of the chromatography paper is in the solvent and that the solvent does not come above the origin. Put the tube carefully back into the rack and do not move it again.

**Figure 1**

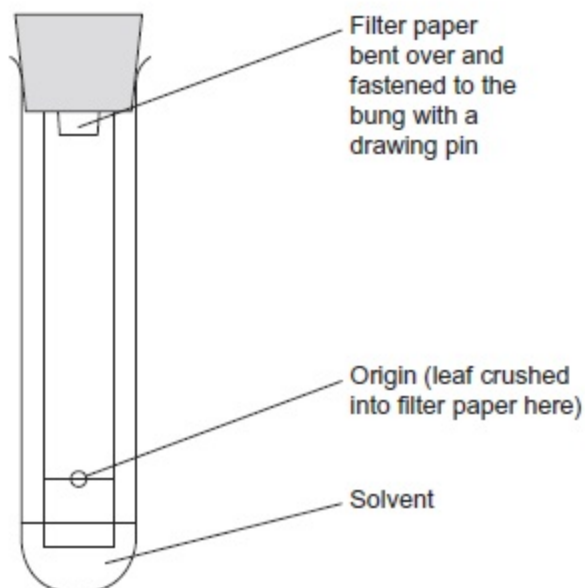

6. Let the solvent run up the chromatography paper until it almost reaches the top of the paper. Remove the chromatography paper from the tube and immediately draw a pencil line to show how far the solvent moved up the paper. This line marks the solvent front.
7. Replace the bung in the tube.
8. The filter paper with its coloured spots is called a chromatogram. Let the chromatogram dry. Using a pencil, draw round each coloured spot on the chromatogram.
9. Repeat step two with the second piece of paper but write B at the top of the chromatography paper.
10. Repeat steps 3–8 with leaf B.

Calculate the R<sub>f</sub> value for each of the pigment spots on each chromatogram.

$$\text{Rf value} = \frac{\text{Distance moved by pigment from origin to centre of pigment spot}}{\text{Distance from origin to solvent front}}$$

---

## A-level Biology example for required practical 7

### Use of chromatography to investigate the pigments isolated from leaves of different plants eg leaves from shade-tolerant and shade-intolerant plants or leaves of different colours: An investigation of pigments present in leaves

#### Teacher notes

This investigation is based on BIO6T/P12

#### Materials

Each student needs:

- boiling-tube rack
- two boiling tubes with bungs
- 10cm<sup>3</sup> glass measuring cylinder
- 10cm<sup>3</sup> solvent
- chromatography paper cut to size to fit the boiling tubes as shown in the diagram. The paper must not touch the sides of the tube. Good quality filter paper can be used but chromatography paper gives better results.
- glass rod to crush leaf tissue into the paper
- two leaves, A and B. These can be different colours or from shade-tolerant and shade-intolerant plants. Autumn leaves can be used to give different colours. The best results come from leaves with a thin cuticle.
- cork borer – or a hole punch could be used to produce the leaf discs
- tile on which to use cork borer
- ruler with millimetre measurements
- pencil
- drawing pins
- marker pen
- sticky tape.

#### Technical information

**Solvent:** Propanone: petroleum ether (b.p. 100–120°C) in ratio of 1:9. This should be supplied to students in a stoppered bottle and labelled 'solvent'.

- Hazcard 85A relates to propanone, highly flammable and causes serious eye irritation (may cause drowsiness).
- Hazcard 45A relates to Petroleum ether, highly flammable, dangerous to the environment.
- Ensure good ventilation in laboratory, no naked flames and wear eye protection. For disposal see Hazcards.

The method given is simple and works well. It avoids the need to grind leaves to extract pigment.

You might want to consider thin layer chromatography instead (see [CLEAPSS video](#)). The safety issues with thin layer chromatography are considerably less due to the much smaller scale.

The chromatograms will fade very quickly, particularly in the light. It is advisable to mark the spots immediately to calculate the R<sub>f</sub> values.

Chromatography paper is better provided pre-cut to prevent over-handling by students. It secures well with a drawing pin to either a cork or a rubber bung.

In trials, a red-leaved beet and a spinach leaf were used. These cut well with a number five cork borer.

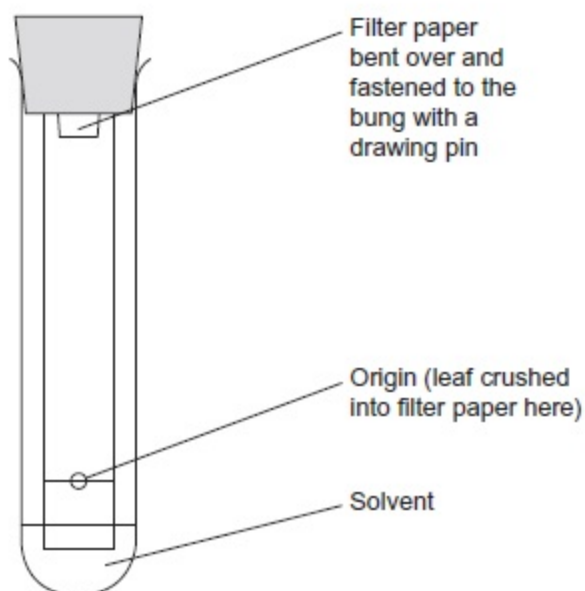

### **Risk assessment**

Risk assessment and risk management are the responsibility of the centre.

### **Trialling**

The practical should be trialled before use with students.

Photographs of an example set-up of this practical can be found in our set-up guide, which is available on our [A-level practicals page](#).

## Practical 8

Required practical		Investigation into the effect of a named factor on the rate of dehydrogenase activity in extracts of chloroplasts			
<b>Apparatus and techniques covered</b>  (Not full statements)	AT a. use appropriate apparatus to record a range of quantitative measurements AT b. use appropriate instrumentation to record quantitative measurements, such as colorimeter AT c. use laboratory glassware apparatus for a variety of experimental techniques				
<b>Indicative apparatus and materials</b>	Spinach leaves, blender, ice, isolation medium, DCPIP, beakers, test tubes, lamp, aluminium foil, timer, colorimeter, cuvettes.				
	<b>Amount of choice</b>				
	<b>Increasing independence</b>				
	Least choice	Some choice	Many choices	Full investigation	
	Teacher chooses the factor to be varied. Students vary the factor and measure dehydrogenase activity using DCPIP colour change. Experiments fully specified in terms of equipment and method.	Teacher allows a limited choice of factors to be varied. Students vary the factor and measure dehydrogenase activity using DCPIP colour change. Experiment probably fully specified by teacher.	Teacher allows a choice of factors to be varied and methods of measuring dehydrogenase activity. Students have a number of experimental procedures to choose from, and then follow that procedure.	Student decides on a question. Student researches methods for carrying out the experiment then chooses equipment, materials, justifying all choices.	
Opportunities for observation and assessment of competencies					
Follow written procedures	✓✓✓ Students follow written method.	✓✓✓ Students follow written method.	✓✓✓ Students follow a method they have chosen.	✓✓✓ Students follow a method they have researched.	
Applies investigative approaches and methods when using instruments and equipment	✓✓ Students must correctly use the appropriate equipment.	✓✓ Students must correctly use the appropriate equipment.	✓✓✓ Students must correctly use the appropriate equipment.	✓✓✓ Students must choose an appropriate approach, equipment and techniques and identify correct variables for measurement and control.	
Safely uses a range of	✓✓ Students must safely use	✓✓ Students must safely use	✓✓✓ Students minimise risks	✓✓✓ Students must carry out a	

practical equipment and materials	the equipment.	the equipment.	with minimal prompting.	full risk assessment and minimise risks.
Makes and records observations	✓ Students record observations in specified ways.	✓ Students record observations in specified ways.	✓✓ Students record observations in specified ways.	✓✓✓ Students must choose the most effective way of recording observations.
Researches, references and reports	✓ Students compare results with ideal and identify reasons for differences.	✓✓ Students compare results with ideal and between students and identify reasons for differences.	✓✓ Students compare results with ideal and between students and identify reasons for differences.	✓✓✓ Students must research alternatives in order to plan their work. Reporting covers the planning, carrying out and an analysis of their results.

✓✓✓: Very good opportunity ✓✓: Good opportunity ✓: Slight opportunity ✕: No opportunity

---

## A-level Biology example for required practical 8

### Investigation into the effect of a named factor on the rate of dehydrogenase activity in extracts of chloroplasts: The effect of ammonium hydroxide on the time taken for chloroplasts to decolourise DCPIP

#### Student sheet

In this investigation you will use a chloroplast suspension and a blue dye called DCPIP to monitor the rate of dehydrogenase activity. DCPIP goes from blue to colourless when it takes up electrons released by chlorophyll.

#### Method

You are provided with the following:

- Spinach leaves
- access to a blender
- measuring cylinder
- muslin (or material for filtering)
- filter funnel
- three beakers
- ice
- isolation medium (cold)
- DCPIP solution (cold)
- distilled water (cold)
- ammonium hydroxide solution (cold)
- test tubes
- test-tube rack
- syringes (1cm<sup>3</sup> and 5cm<sup>3</sup>)
- piece of aluminium foil
- lamp
- marker pen
- timer.

You should read these instructions carefully before you start work.

1. Put about 50cm<sup>3</sup> of isolation medium into a beaker.
2. Tear eight spinach leaves into small pieces and put the pieces into the isolation medium in the beaker. Do not put pieces of the midrib or the leaf stalk into the beaker.
3. Half-fill a large beaker with ice and place a small beaker on top of the ice.
4. Put three layers of muslin over the top of the filter funnel and wet it with the isolation medium. Rest the filter funnel in the small beaker on the ice.
5. Pour the spinach and isolation medium into the blender and blend for about 15 seconds. Pour the blended mixture back into the beaker.
6. Pour a little of your blended mixture through the muslin in the filter funnel. Carefully fold and squeeze the muslin to assist the filtering process. Repeat until most of the blended mixture has been filtered. Label this filtrate in the small beaker on ice as 'chloroplast suspension'.
7. Label five test tubes **A**, **B**, **C**, **X** and **Y**. Stand these five tubes in the ice in the large beaker. Position the lamp about 10cm from the beaker so that all tubes are illuminated. Turn on the lamp.
8. Set up tubes **A** and **B** as follows:
  - Tube A**  
Put 5cm<sup>3</sup> DCPIP solution + 1cm<sup>3</sup> water + 1cm<sup>3</sup> chloroplast suspension in the tube. Immediately wrap the tube completely in aluminium foil to exclude light.
  - Tube B**  
Put 5cm<sup>3</sup> DCPIP solution + 1cm<sup>3</sup> water + 1cm<sup>3</sup> isolation medium in the tube.

---

Tubes **A** and **B** are control experiments. Leave both tubes until the end of your investigation.

9. Set up tube **C** as follows:

**Tube C**

Put  $6\text{cm}^3$  water +  $1\text{cm}^3$  chloroplast suspension in the tube.

Tube **C** is for you to use as a standard to help you to determine when any colour change is complete.

10. Set up tube **X** as follows:

**Tube X**

Put  $5\text{cm}^3$  DCPIP solution +  $1\text{cm}^3$  water in the tube.

Add  $1\text{cm}^3$  chloroplast suspension to tube **X**, quickly mix the contents and start the timer.

Record in seconds how long it takes for the contents of tube **X** to change colour from blue-green to green. This is when all signs of blue have disappeared. Use tube **C** to help you determine when the colour change is complete.

11. Repeat step 10 four more times.

12. Set up tube **Y** as follows:

**Tube Y**

Put  $5\text{cm}^3$  DCPIP solution +  $1\text{cm}^3$  ammonium hydroxide in the tube.

Add  $1\text{cm}^3$  chloroplast suspension to tube **Y**, quickly mix the contents and start the timer.

Record in seconds how long it takes for the contents of tube **Y** to change colour from blue-green to green. This is when all signs of blue have disappeared. Use tube **C** to help you determine when the colour change is complete. However if this has not taken place within 300 seconds (five minutes), record the colour at this point.

13. Repeat step 12 four more times.

14. Record your data in a suitable table.

15. At the end of your investigation, record the colour of the mixtures in tubes **A** and **B**.



---

A-level Biology example for required practical 8

**Investigation into the effect of a named factor on the rate of dehydrogenase activity in extracts of chloroplasts:**

**The effect of ammonium hydroxide on the time taken for chloroplasts to decolourise DCPIP**

### Teacher notes

This investigation is based on BIO6T/P11

This investigation uses ammonium hydroxide as the named factor as it is readily available and can be used to mimic the effect of weed killer.

### Materials

In addition to general laboratory apparatus each student needs:

- Eight spinach leaves
- access to a blender
- measuring cylinder (50cm<sup>3</sup> or 100cm<sup>3</sup>)
- muslin (or material for filtering J-cloth style dishcloths are suitable)
- filter funnel
- 3 beakers (1 large, 2 small)
- ice – to half fill the large beaker
- isolation medium (cold)
- DCPIP solution (cold)
- distilled water (cold)
- ammonium hydroxide solution (cold) (1.0 mol dm<sup>-3</sup>)
- test tubes
- test-tube rack
- syringes (4× 1cm<sup>3</sup> and 2× 5cm<sup>3</sup>)
- piece of aluminium foil large enough to completely wrap test tube
- lamp
- marker pen
- timer.

### Technical information

**Spinach leaves** – these should be left in the light for a few hours before the investigation begins, but do not allow the leaves to get too hot. Bagged spinach works well if left in the light for about one hour before use.

A class set of spinach can be blended if there is only one large blender available. Use the recommended number of leaves and amount of isolation medium per student but blend all together then give students the suspension in cold beakers.

#### Phosphate buffer solution (per 500cm<sup>3</sup>)

Dissolve 4.48g Na<sub>2</sub>HPO<sub>4</sub>·12H<sub>2</sub>O and 1.7g KH<sub>2</sub>PO<sub>4</sub> in 500cm<sup>3</sup> distilled water. Keep cool until required.

#### Isolation medium (per 250cm<sup>3</sup>)

Dissolve 34.23 g sucrose and 0.19 g KCl in phosphate buffer solution and make up to 250cm<sup>3</sup> with phosphate buffer solution. Keep cool until required.

#### DCPIP solution (per 250cm<sup>3</sup>)

Dissolve 0.01g DCPIP and 0.93g KCl in phosphate buffer solution and make up to 250cm<sup>3</sup> with phosphate buffer solution. Keep cool until required.

---

## Ammonium hydroxide solution (1.0 mol dm<sup>-3</sup>)

Keep cool until required.

All solutions should be kept in a fridge for 24 hours before use. It is advisable to have a set of cold beakers for the chloroplast suspension if individual blending is not done.

### Additional information

- Take care with use of mercury containing light bulbs. Consult CLEAPSS guidance if breakages occur.
- Take care with the very bright lights (>1000 lumens) needed for this practical to work. The light will not damage the retina, but the long lasting afterimage can worry. Students should be cautioned not to look directly at the light.
- Take care with water next to electrical connections.

### Notes on alternative methods

The method given does not use a colorimeter and requires students to use a standard to compare colour by eye. Better results will be achieved using a colorimeter as the changes are difficult to see.

To use a colorimeter, the following changes need to be made at certain steps:

9. Set up tube **C** as follows:

#### Tube C

Put 6cm<sup>3</sup> water + 1cm<sup>3</sup> chloroplast suspension in the tube.

Tube **C** is for you to use as a standard.

Set up the colorimeter and use the mixture in tube **C** to set the absorbance to zero.

10. Set up tube **X** as follows:

#### Tube X

Put 5cm<sup>3</sup> DCPIP solution + 1cm<sup>3</sup> water in the tube.

Add 1cm<sup>3</sup> chloroplast suspension to tube **X**, quickly mix the contents and start the timer. After exactly two minutes measure the absorbance of the mixture in the colorimeter.

11. Repeat step 10 four more times.

12. Set up tube **Y** as follows:

#### Tube Y

Put 5cm<sup>3</sup> DCPIP solution + 1cm<sup>3</sup> ammonium hydroxide in the tube.

Add 1cm<sup>3</sup> chloroplast suspension to tube **Y**, quickly mix the contents and start the timer. After exactly two minutes measure the absorbance of the mixture in the colorimeter.

13. Repeat step 12 four more times.

If a colour change is not detected in the time scale suggested then the DCPIP can be diluted further or the time can be increased.

### Risk assessment

Risk assessment and risk management are the responsibility of the centre.

### Trialling

The practical should be trialled before use with students.

---

### Sample results

The mean length of time it taken for tube **X** to decolourise was 185 seconds (blue to green colour).

Tube **Y** was a dark green after five minutes.

At the end of the experiment, tube **A** was blue-green; tube **B** was blue and tube **C** was green.

Photographs of an example set-up of this practical can be found in our set-up guide, which is available on our [A-level practicals page](#).

## Practical 9

Required practical		Investigation into the effect of a named variable on the rate of respiration of cultures of single-celled organisms			
<b>Apparatus and techniques covered</b>  (Not full statements)	AT a. use appropriate apparatus to record a range of quantitative measurements AT b. use appropriate instrumentation to record quantitative measurements AT c. use laboratory glassware apparatus for a variety of experimental techniques AT i. use microbiological aseptic techniques				
<b>Indicative apparatus and materials</b>	Yeast suspension, glucose solution, methylene blue indicator solution, test tubes, graduated pipettes and fillers, water bath, timer (or could measure volume of gas given off using a manometer).				
		Amount of choice			
		Increasing independence			
		Least choice	Some choice	Many choices	Full investigation
		Teacher chooses the organism and the factor to be varied. Students vary the factor and measure the rate of respiration. Experiments fully specified in terms of equipment and method.	Teacher allows a limited choice of factors to be varied. Students vary the factor and measure the rate of respiration. Experiment probably fully specified by teacher.	Teacher allows a choice of factor. Students have a number of experimental procedures to choose from, and then follow that procedure.	Student decides on a question. Student researches methods for carrying out the experiment then chooses equipment, materials, justifying all choices.
Opportunities for observation and assessment of competencies					
Follow written procedures	✓✓✓ Students follow written method.	✓✓✓ Students follow written method.	✓✓✓ Students follow a method they have chosen.	✓✓✓ Students follow a method they have researched.	
Applies investigative approaches and methods when using instruments and equipment	✓ Students must correctly use the appropriate equipment.	✓ Students must correctly use the appropriate equipment.	✓✓ Students must correctly use the appropriate equipment.	✓✓✓ Students must choose an appropriate approach, equipment and techniques and identify correct variables for measurement and control.	
Safely uses a range of	✓ Students must safely use the	✓ Students must safely use the	✓✓ Students minimise risks	✓✓✓ Students must carry out a	

practical equipment and materials	equipment.	equipment.	with minimal prompting.	full risk assessment and minimise risks.
Makes and records observations	✓ Students record measurements in specified ways and calculate rate of respiration.	✓ Students record measurements in specified ways and calculate rate of respiration.	✓ Students record measurements in specified ways and calculate rate of respiration.	✓✓✓ Students must choose the most effective way of recording measurements and calculating rate of respiration.
Researches, references and reports	✓ Students compare results between students and identify reasons for differences.	✓✓ Students compare results between students and identify reasons for differences.	✓✓ Students compare results with ideal and between students and identify reasons for differences.	✓✓✓ Students must research alternatives in order to plan their work. Reporting covers the planning, carrying out and an analysis of their results.

✓✓✓: Very good opportunity ✓✓: Good opportunity ✓: Slight opportunity ✗: No opportunity

---

A-level Biology example for required practical 9

**Investigation into the effect of a named variable on the rate of respiration of cultures of single-celled organisms:**

**An investigation of the effect of temperature on respiration in yeast**

**Student sheet**

Yeast is a single-celled fungus. It can respire aerobically and anaerobically. During aerobic respiration, the transport of electrons is linked to the synthesis of ATP. In this investigation, these electrons will be taken up by a substance called methylene blue. When methylene blue is reduced, it changes from blue to colourless.

**Method**

You are provided with the following:

- yeast and glucose mixture
- methylene blue
- test tubes
- test-tube rack
- beaker to act as water bath
- a way of changing the temperature of the water bath
- graduated pipettes or syringes
- marker pen
- thermometer
- timer.

You should read these instructions carefully before you start your investigation.

1. Use the beaker to set up a water bath at 35°C.
2. Label five test tubes one to five.
3. Shake the yeast and glucose mixture.
4. Add 2cm<sup>3</sup> of the yeast and glucose mixture to all five tubes.
5. Place all five tubes in the water bath and leave them until their contents reach 35°C. Make sure the water bath stays at 35°C
6. Add 2cm<sup>3</sup> methylene blue to test tube 1.
7. Immediately shake this tube for 10 seconds and replace the tube in the water bath. Note the time and do not shake this tube again.
8. Record how long it takes for the blue colour to disappear in the tube.
9. Repeat steps six to eight for the other four tubes.
10. Your teacher will tell you which other temperatures to use. Repeat steps one to nine at each temperature.

---

A-level Biology example for required practical 9

**Investigation into the effect of a named variable on the rate of respiration of cultures of single-celled organisms:**

**An investigation of the effect of temperature on respiration in yeast**

**Teacher notes**

This investigation is based on BIO6T/Q12

**Materials**

- yeast and glucose mixture
  - methylene blue
  - test tubes
  - test-tube rack
  - beaker to act as water bath
  - a way of changing the temperature of the water bath eg Bunsen burner or supplies of hot or cold water. The experiment
- needs to be in a glass beaker so colour change can be observed so an electric water bath is not really suitable.
- 2cm<sup>3</sup> graduated pipettes or syringes
  - marker pen
  - thermometer
  - timer.

**Technical information**

Make up a solution of 1g glucose in 100cm<sup>3</sup> water. Just before use, raise the temperature of this solution to 30°C and add 5 g dried yeast. Shake to suspend the yeast in the glucose solution. Use an open-topped flask or beaker as bubbling will occur (if bubbling does not occur, check that the yeast used is not old).

The yeast must be checked as it needs to be active. Freshly-purchased dried yeast was used in trials as yeast that was already in stock did not give good results. The yeast needs to be fresh and well fermenting at the start of the experiment.

**Methylene blue solution**

Make a stock solution of 1 g methylene blue and 0.6 g sodium chloride dissolved in 100cm<sup>3</sup> water. For the solution to be used in the investigation, take 0.1cm<sup>3</sup> of the stock solution and add it to 100cm<sup>3</sup> water.

Decolourisation of the methylene blue should occur within approximately 5 minutes when the experiment is conducted at 35°C. If it is taking longer than this the methylene blue solution can be diluted further. In some trials, the methylene blue had to be diluted further (1:1) in order to get results within 5 minutes.

The stock solution of methylene blue should be prepared in advance as the concentration means the methylene blue takes a while to fully dissolve. It can be diluted to the working concentration on the day of use.

**Additional information**

An alternative method includes a different recipe for the yeast. To 250cm<sup>3</sup> of tap water, add 25g of yeast and 12.5 g of glucose and leave this for 24 hours in a 25°C water bath. The methylene blue

---

used in this method should be at 0.005% and 5cm<sup>3</sup> yeast and 1cm<sup>3</sup> methylene blue should be added to each test tube.

Other suggested alternatives are to use Janus green (diazine green) in place of methylene blue. The indicator reduces to a pink colour when all the oxygen is used up instead of decolourising.

The amount of indicator needed is less critical. All that is needed is to make initial yeast solution a noticeable blue/green colour.

### **Risk assessment**

Risk assessment and risk management are the responsibility of the centre.

### **Trialling**

The practical should be trialled before use with students.

It is advised to trial this experiment using the batch of yeast and methylene blue that will be used by students as yeast activity can vary considerably. Trials need to establish the safest range of temperatures that is effective. It is not necessary to use very high temperatures to get results as it is not the aim of the experiment to find the optimum temperature.

This method for investigating rate of respiration in single-celled organisms is simple and needs little apparatus. Rate of anaerobic respiration can be investigated using a respirometer if this apparatus is available.

### **Sample results**

Mean decolourisation times during trials were:

<b>Temperature/°C</b>	<b>Mean decolourisation time/s</b>
20	275
35	128
45	145

Photographs of an example set-up of this practical can be found in our set-up guide, which is available on our [A-level practicals page](#).



## Practical 10

<b>Required practical</b>	<b>Investigation into the effect of an environmental variable on the movement of an animal using either a choice chamber or a maze</b>			
<b>Apparatus and techniques covered</b>  (Not full statements)	AT h. safely and ethically use organisms to measure animal responses.			
<b>Indicative apparatus and materials</b>	Maggots or woodlice, paper maze or choice chamber, anhydrous calcium chloride, black paper, bench lamp.			
	<b>Amount of choice</b>			
	<b>Increasing independence</b>			
	Least choice	Some choice	Many choices	Full investigation
	Teacher chooses the animal and the environmental variable. Students control the variable and observe the behaviour. Experiments fully specified in terms of equipment and method.	Teacher allows a limited choice of environmental variable. Students control the variable and observe the behaviour. Experiment probably fully specified by teacher.	Teacher allows a choice of environmental variable and method of observing behaviour. Students have a number of experimental procedures to choose from, and then follow that procedure.	Student decides on a question. Student researches methods for carrying out the experiment then chooses equipment and materials, justifying all choices.
<b>Opportunities for observation and assessment of competencies</b>				
Follow written procedures	✓✓✓ Students follow written method.	✓✓✓ Students follow written method.	✓✓✓ Students follow a method they have chosen.	✓✓✓ Students follow a method they have researched.
Applies investigative approaches and methods when using instruments and equipment	✓ Students must correctly use the appropriate equipment.	✓ Students must correctly use the appropriate equipment.	✓✓ Students must correctly use the appropriate equipment.	✓✓✓ Students must choose an appropriate approach, equipment and techniques and identify correct variables for measurement and control.
Safely uses a range of practical equipment	✓ Students must safely use the equipment and treat animals	✓ Students must safely use the equipment and treat animals	✓✓ Students minimise risks with minimal prompting and	✓✓✓ Students must carry out a full risk assessment to

and materials	ethically.	ethically.	treat animals ethically.	minimise risks and treat animals ethically.
Makes and records observations	✓ Students record observations in specified ways.	✓ Students record observations in specified ways.	✓ Students record observations in specified ways.	✓✓✓ Students must choose the most effective way of recording observations.
Researches, references and reports	✓ Students compare results between students and identify reasons for differences.	✓✓ Students compare results between students and identify reasons for differences.	✓✓ Students compare results with ideal and between students and identify reasons for differences.	✓✓✓ Students must research alternatives in order to plan their work. Reporting covers the planning, carrying out and an analysis of their results.

✓✓✓: Very good opportunity ✓✓: Good opportunity ✓: Slight opportunity ✕: No opportunity

## A-level Biology example for required practical 10

### Investigation into the effect of an environmental variable on the movement of an animal using either a choice chamber or a maze:

#### Using choice chambers to investigate responses of invertebrates to light/dark and humid/dry conditions

#### Student sheet

#### Method

You are provided with the following:

- a choice chamber with nylon mesh fabric
- silica gel
- humidity test strips (cobalt chloride strips which have been dried – blue when dry and pink when moist)
- paper towels (or filter paper or cotton wool)
- water
- black paper
- adhesive tape
- maggots (or woodlice)
- beaker
- teaspoon
- forceps.

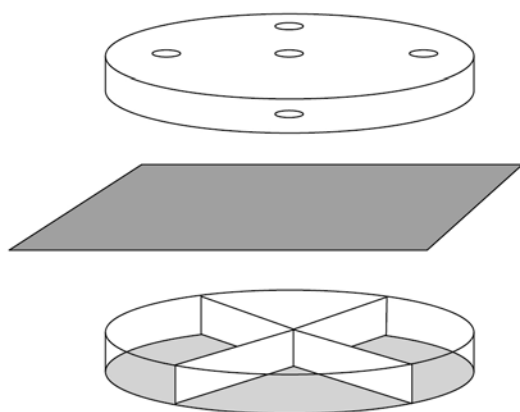

Holes in the lid allow maggots to be put into the chamber. Covering the top and sides with card can create light and dark areas.

Trap the fabric between the lid and the base. The maggots can move freely on this surface.

The base of choice chamber is divided into four quarters. Each one can have a different environment.

Water in one half of the base will create an area with a moist environment. Silica gel in the other half will create a dry environment.

#### Control experiment

1. Set up the choice chamber with nothing in the base quarters.
2. Place 12 maggots in the chamber through the central hole, using the teaspoon.
3. Wait four minutes then record the number of maggots in the left and right halves of the choice chamber. Record your results.

If the left and right halves have no effect on the distribution of the maggots the expected results would be six in each half, but this will not always occur because of chance distribution. If your results are not 6 in each half, do a statistical test on your results to discover the probability of them occurring by chance. If this test shows a greater than 5% probability of the results occurring by chance, you can proceed with the experiment.

---

### **The effect of light**

1. Cover half the choice chamber with black paper to make it dark.
2. Place 12 maggots in the chamber through the central hole, using the teaspoon.
3. Wait four minutes and then record the number of maggots in the dark and the light halves.

If light has no effect on the distribution of maggots the expected results would be six in each half. Now do a statistical test on your results to find the probability of the difference between your results and your expected results occurring by chance.

### **The effect of humidity**

1. Place damp paper towel, damp filter paper or damp cotton wool in one half of the choice chamber. Being careful not to get the gauze wet, put a small amount of water in the test area in one half of the choice chamber. Then add some paper towel or filter paper to soak up the water. Cotton wool can also be used in a thin layer.
2. Add silica gel in the other half of the choice chamber
3. Use the humidity test strips to ensure that a humidity gradient exists in the chamber before adding the maggots. The humidity can be tested by trapping the humidity test strip in the edge of the choice chamber on the surface of the gauze. Use the forceps to place the humidity test strip.
4. Leave for five minutes.
5. Place 12 maggots in the chamber through the central hole.
6. Wait four minutes and then record the number of maggots in the humid and the dry halves.

### **The effect of light and humidity**

In reality, living organisms do not have simple choices between one pair of contrasting environmental factors. If you have time, do a final experiment with the choice between dark and dry, dark and humid, light and dry, light and humid. Again test the probability of any difference between your results and your predicted results occurring by chance with an appropriate statistical test.

---

## Alternative practical using a maze

### Turning behaviour in maggots

You are provided with the following:

- a maze printed on card
- scissors
- glue
- maggots
- cotton wool buds
- a plastic teaspoon.

You should read these instructions carefully before you start work.

1. Cut out pieces **A**, **B** and **C** from the card by cutting along all the solid lines.
2. Fold along the dashed and dotted lines, keeping dashes on the inside and dots on the outside.
3. Glue the tabs to form the maze shown below.

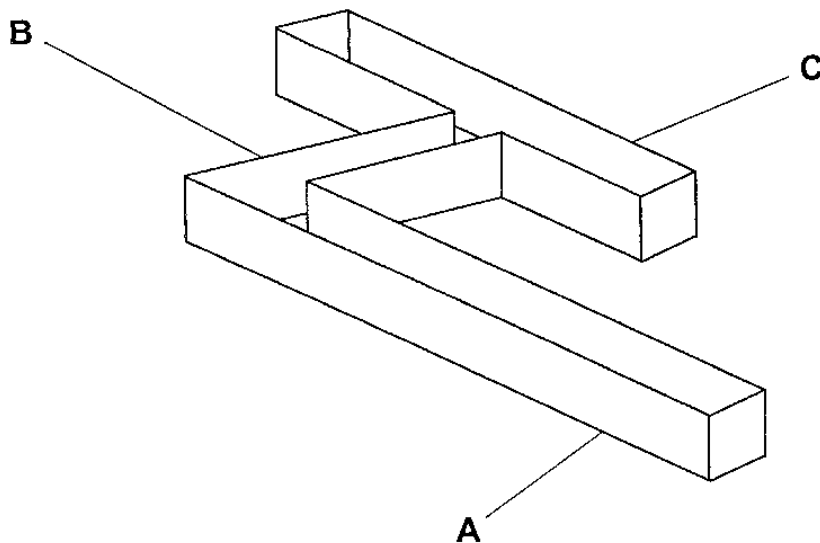

---

Cut out the barrier (piece **D**) and place it at the position shown below.

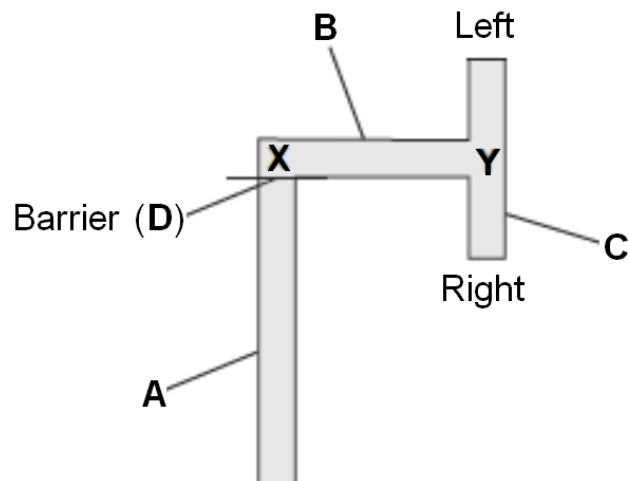

4. Place a maggot at point **X** using the plastic teaspoon.
5. Record in a table whether the maggot turns left or right when it reaches the junction at **Y**.
6. Remove the maggot from the maze.
7. Wipe the inside of the maze with a cotton wool bud.
8. Repeat steps five to eight until you have results for 10 maggots.
9. If a maggot stops moving, remove it from the maze and carry out another trial.

This experiment should give equal numbers turning left and right. This section of the maze could be used to investigate the effect of variables such as light by covering one side of the maze with black paper and then the other.

---

## Turn alternation in maggots

Many animals show behaviour called turn alternation. This means if the animal is forced to turn in one direction it is more likely to turn in the opposite direction next time it has a choice. The maze can be used to allow you to investigate whether maggots show turn alternation.

1. Use the maze you made in Task 1, with barrier **D** removed.

### Plan of the maze

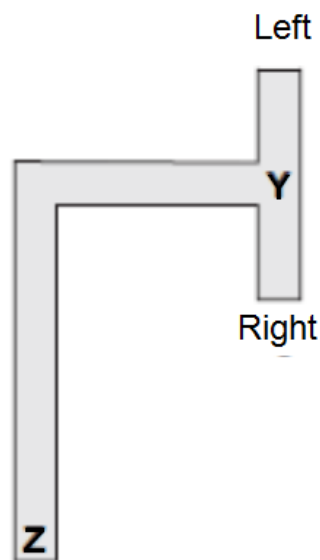

2. Place a maggot at point **Z** in the maze.
3. Record whether the maggot turns left or right when it reaches the junction at **Y**.
4. Repeat steps two and three until another 9 times.
5. Record your data in a suitable table.

---

A-level Biology example for required practical 10

**Investigation into the effect of an environmental variable on the movement of an animal using either a choice chamber or a maze:**

**Using choice chambers to investigate responses in invertebrates to light/dark and humid/dry conditions**

### Teacher notes

#### Materials

In addition to general laboratory equipment each student needs:

- a choice chamber with nylon mesh fabric
- silica gel or calcium chloride (dehydrating agent)
- humidity test strips (cobalt chloride strips which have been dried – blue when dry and pink when moist)
- paper towels (or filter paper or cotton wool)
- water
- black paper and scissors to cut to shape.
- adhesive tape
- maggots (or woodlice)
- beaker to hold maggots or woodlice
- teaspoon.

This is a simple experiment if choice chambers are available. Care should be taken that the damp paper towel does not touch the nylon mesh fabric.

**Alternative practical using a maze** (based on BIO6X 2011)

### Turning behaviour in maggots

#### Materials

- a maze printed on card
- scissors
- glue
- maggots
- cotton wool buds
- a plastic teaspoon.



### Pattern for Maze

Attach this end to **B**

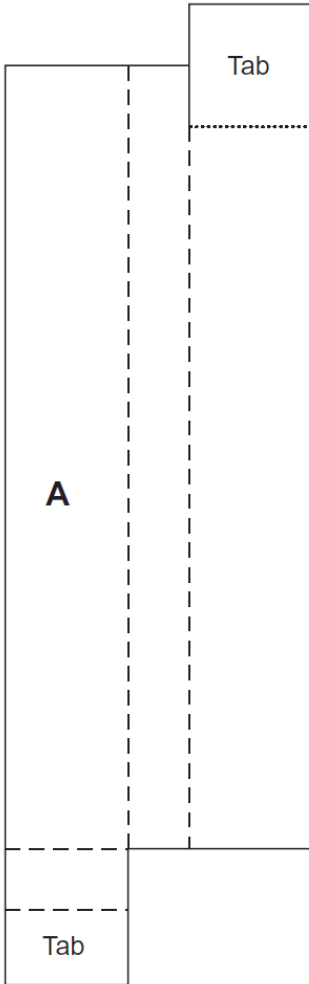

Attach this end to **A**

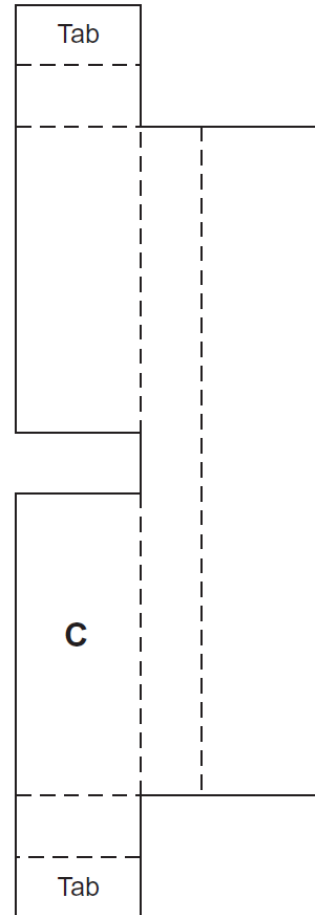
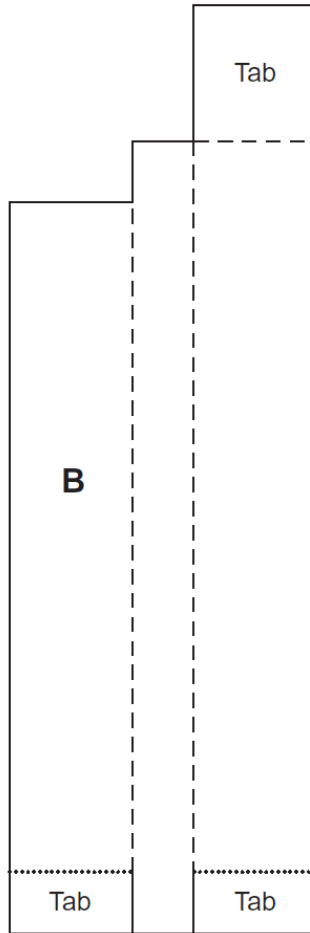

Attach this end to **C**

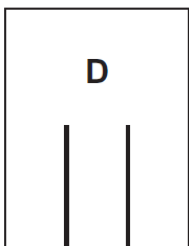

Barrier

- Cut along all solid lines.
- Fold along dashed and dotted lines, keeping dashed lines on the inside and dotted lines on the outside.

---

## Risk assessment

Risk assessment and risk management are the responsibility of the centre.

## Trialling

The practical should be trialled before use with students.

## Additional notes

Maggots, if used instead, can be purchased from fishing shops and can be stored in the fridge for a few days before use.

The Bluebottle adult flies hatching from the maggots are classed as statutory nuisance animals by DEFRA (listed in document *Nuisance Insects and Climate Change* March 2009). The maggots should therefore be killed (eg by placing in a freezer for a week) before wrapping securely and placing in a bin collected directly by refuse collectors. Animals that have been used in experimental work are regarded as animal by-products and as such should not enter the food chain. For disposal, the flies should be killed as described above, and placed in the normal refuse.

See Hazcard 25 for cobalt chloride papers, and found in self-indicating silica gel, causes skin sensitisation. The chemical is also potentially carcinogenic by inhalation. Students should use forceps to place the cobalt chloride paper in the choice chamber. Students should not directly handle the papers or self-indicating silica gel.

This practical was trialled with woodlice, which are kept in a tank in school. They are easy to keep and become a self-sustaining colony very quickly. The tank is kept out of direct sunlight and contains earth and decaying plant material. Fresh potato peelings are added occasionally and any organic matter is checked for other insects and spiders before adding to the tank. Woodlice are frequently found in gardens and areas of decaying matter, under stones etc. Once established, the woodlice provide an interesting addition to the department and a useful resource for environmental experiments.

## Sample results

In trials, using woodlice in a choice chamber, the results were as follows:

In the control, 12 woodlice were separated into eight on one side and four on the other after four minutes.

In the light/dark, 12 woodlice were separated into two on the light side and 10 on the dark side after 4 minutes.

In the humid/dry, 12 woodlice were separated into 1 on the dry side and 11 on the humid side after four minutes.

Photographs of an example set-up of this practical can be found in our set-up guide, which is available on our [A-level practicals page](#).

## Practical 11

<b>Required practical</b>	<b>Production of a dilution series of a glucose solution and use of colorimetric techniques to produce a calibration curve with which to identify the concentration of glucose in an unknown 'urine' sample</b>
<b>Apparatus and techniques covered</b>  (Not full statements)	AT b. use appropriate instrumentation to record quantitative measurements, such as a colorimeter AT c. use laboratory glassware apparatus for a variety of experimental techniques AT f. use qualitative reagents to identify biological molecules
<b>Indicative apparatus and materials</b>	glucose solution, distilled water, Clinistix, Benedict's solution, graduated pipettes and fillers, test tubes, water bath, colorimeter and cuvettes

<b>Amount of choice</b>				
<b>Increasing independence</b>		<b>→</b>		
Least choice	Some choice	Many choices	Full investigation	
Teacher chooses the concentration of standard glucose solution and values for serial dilution. Volumes of glucose solution and water are given for serial dilution. Students produce dilutions and after reacting with Benedict's reagent produce a calibration curve. Unknown 'urine' sample is reacted with Benedict's reagent and the value of glucose concentration is read from the calibration curve. Experiments fully specified in terms of equipment and method.	Teacher provides concentration of standard glucose solution but students decide on values for serial dilution. Students produce dilutions and after reacting with Benedict's reagent produce a calibration curve. Unknown 'urine' sample is reacted with Benedict's reagent and the value of glucose concentration is read from the calibration curve. Experiment probably fully specified by teacher.	Student decides on range of glucose concentrations for calibration curve. Students produce dilutions and after reacting with Benedict's reagent produce a calibration curve. Unknown 'urine' sample is reacted with Benedict's reagent and the value of glucose concentration is read from the calibration curve. Teacher provides outline method only.	Student is presented with the urine of suspected diabetic. Student researches methods for finding out the concentration of glucose in the urine, then chooses equipment and materials, justifying all choices.	

Opportunities for observation and assessment of competencies				
Follow written procedures	✓✓✓ Students follow written method.	✓✓✓ Students follow written method.	✓✓ Students follow an outline method	✓✓✓ Students follow a method they have researched.
Applies investigative approaches and methods when using instruments and equipment	✓✓ Students must correctly use the appropriate equipment.	✓✓ Students must correctly use the appropriate equipment.	✓✓ Students must correctly use the appropriate equipment.	✓✓✓ Students must choose an appropriate approach, equipment and techniques and, identify correct variables for measurement and control.
Safely uses a range of practical equipment and materials	✓ Students must safely use the equipment.	✓ Students must safely use the equipment.	✓✓ Students minimise risks with minimal prompting.	✓✓✓ Students must carry out a full risk assessment and minimise risks.
Makes and records observations	✓ Students record colorimeter readings and plot calibration curve.	✓ Students record colorimeter readings and plot calibration curve.	✓ Students record colorimeter readings and plot calibration curve.	✓✓✓ Students must choose the most effective way of recording measurements and producing calibration curve.
Researches, references and reports	✓ Students compare results with normal glucose concentrations and identify reasons for differences.	✓✓ Students compare results with normal glucose concentrations and identify reasons for differences.	✓✓ Students compare results with normal glucose concentrations and identify reasons for differences.	✓✓✓ Students must research alternatives in order to plan their work. Reporting covers the planning, carrying out and an analysis of their results in relation to normal glucose concentrations.

✓✓✓: Very good opportunity ✓✓: Good opportunity ✓: Slight opportunity ✗: No opportunity

## A-level Biology example for required practical 11

### Production of a dilution series of a glucose solution and use of colorimetric techniques to produce a calibration curve with which to identify the concentration of glucose in an unknown 'urine' sample

#### Student sheet

Glucose in the urine is one of the first indications of diabetes.

#### Method

You are provided with the following:

- 10 mmol dm<sup>-3</sup> glucose standard.
- distilled water
- urine samples from "Tom", "Dick" and "Harry"
- Benedict's solution
- graduated pipettes (2cm<sup>3</sup> and 1cm<sup>3</sup>) and pipette filler
- test tubes
- test-tube rack
- water bath set at 90°C
- colorimeter and cuvettes.

#### Prepare urine samples for testing

1. Label the test tubes with the name of the patient and add 2cm<sup>3</sup> urine samples from each patient.
2. To each test tube, add 2cm<sup>3</sup> Benedict's solution. Mix the contents of each tube.

#### Prepare the glucose calibration curve

1. Label six test tubes 0 to 10 mmol dm<sup>-3</sup> as shown in the table below.
2. Dilute the glucose standard (10 mmol dm<sup>-3</sup>) with water in the labelled test tubes and complete the table to show volumes used to achieve each concentration.

Concentration of final solution/ mmol dm <sup>-3</sup>	0.0	2.0	4.0	6.0	8.0	10.0
Volume of water/cm <sup>3</sup>	2.0					
Volume of glucose standard/cm <sup>3</sup>	0.0					

3. Add 2cm<sup>3</sup> of Benedict's solution to each tube. Mix the contents of each tube.
4. Place all the test tubes into the water bath together (including the tubes with the urine samples) and leave them for four minutes. Allow to cool before taking readings from the colorimeter.
5. Use the contents of the 0.0 mmol dm<sup>-3</sup> glucose solution tube, which you have heated with Benedict's, as a blank to calibrate the colorimeter to zero absorbance. Place the remaining samples in cuvettes into the colorimeter and read their absorbances.

- 
6. Record your results in a table and plot a graph of absorbance against the known concentrations of glucose.
  7. Using the graph and the absorbance values obtained for the urine samples, read off from the graph the concentration of glucose in the urine samples.
  8. Record your results in a suitable table.

---

## A-level Biology example for required practical 11

### **Production of a dilution series of a glucose solution and use of colorimetric techniques to produce a calibration curve with which to identify the concentration of glucose in an unknown 'urine' sample**

#### **Teacher notes**

#### **Materials**

- glucose standard
- distilled water
- urine samples from "Tom", "Dick" and "Harry"
- Benedict's solution
- graduated pipettes (2cm<sup>3</sup> and 1cm<sup>3</sup>) and pipette filler
- test tubes
- test-tube rack
- water bath set at 90°C
- colorimeter and cuvettes.

#### **Technical Information**

Glucose standard solution 10 mmol dm<sup>-3</sup>

Dissolve 1.8 g glucose in 1 dm<sup>3</sup> water

#### **"Urine" samples (these can be varied)**

Tom            0 mmol dm<sup>-3</sup> glucose solution

Dick           5 mmol dm<sup>-3</sup> glucose solution

Harry         8 mmol dm<sup>-3</sup> glucose solution

Add weak tea to the water used to colour the "urine" samples.

#### **Benedict's solution**

Although results can be obtained using qualitative Benedict's solution, more reliable results can be achieved using quantitative Benedict's solution. CLEAPSS Recipe Sheet 12 gives the instructions for making up the quantitative chemical.

If the solutions are too dark when reacted with Benedict's to use in the colorimeter, dilute the glucose standard but still label it as 10 mmol dm<sup>-3</sup>

#### **Risk assessment**

Risk assessment and risk management are the responsibility of the centre.

---

## Trialling

The practical should be trialled before use with students.

## Additional notes

Eye protection should be worn should be worn when using Benedict's solution.

Syringes can be used in place of graduated pipettes.

Photographs of an example set-up of this practical can be found in our set-up guide, which is available on our [A-level practicals page](#).

In the photographs, two alternatives are shown for the calibration curve. The blue-orange set uses the qualitative Benedict's solution and the blue-clear set uses the quantitative Benedict's solution. Quantitative Benedict's solution produces a white precipitate which interferes with the absorbance so care must be taken that this precipitate is not transferred to the cuvettes for analysis. Careful pipetting of the solution into the cuvette can achieve this. Filtering is an alternative but the volumes are too small to get enough sample for analysis.

Quantitative Benedict's measures absence of the blue colour and not the formation of red copper oxide. If students are not aware of this they pour the samples away as they think that they have not worked.

600nm used for qualitative Benedict's (orange/red filter)

680nm used for quantitative Benedict's (red filter).

## Sample results

Sample results at 600nm with qualitative Benedict's solution.

Glucose concentration/ mmol dm <sup>-3</sup>	Absorbance
0.0	0.00
2.0	0.76
4.0	1.00
6.0	1.15
8.0	1.22
10.0	1.39

Tom – absorbance = 0.00

Dick – absorbance = 0.89

Harry – absorbance = 1.19

This equates to Dick being 4.70 mmol dm<sup>-3</sup> glucose and Harry being 7.00 mmol dm<sup>-3</sup>.



## Practical 12

Required practical		Investigation into the effect of a named environmental factor on the distribution of a given species			
<b>Apparatus and techniques covered</b>  (Not full statements)	AT a. use appropriate apparatus to record a range of quantitative measurements AT b. use appropriate instrumentation to record quantitative measurements, AT h. safely and ethically use organisms to measure: plant or animal distribution AT k. use sampling techniques in fieldwork AT l. use ICT such as data logger to collect data or use software to process data				
<b>Indicative apparatus and materials</b>	Tape measures, random number tables, species identification chart, quadrats (could use point quadrat).				
		Amount of choice			
		Increasing independence			
		Least choice	Some choice	Many choices	Full investigation
		Teacher chooses the species and the environmental factor to be investigated. Students use random sampling to investigate the distribution of the species. Experiments fully specified in terms of equipment and method.	Teacher allows a limited choice of environmental factors. Students use random sampling to investigate the distribution of the species. Experiment probably fully specified by teacher.	Teacher allows a choice of species and environmental factors. Students use random sampling to investigate the distribution of the species. Outline method provided by teacher.	Student decides on a question. Student researches methods for carrying out the experiment then chooses equipment, materials, justifying all choices.
Opportunities for observation and assessment of competencies					
Follow written procedures	✓✓✓ Students follow written method.	✓✓✓ Students follow written method.	✓✓ Students follow an outline method.	✓✓✓ Students follow a method they have researched.	
Applies investigative approaches and methods when using instruments and equipment	✓ Students measure the environmental variable then use random sampling to investigate the distribution of the species.	✓ Students measure the environmental variable then use random sampling to investigate the distribution of the species.	✓✓ Students measure the environmental variable then use random sampling to investigate the distribution of the species.	✓✓✓ Students must choose an appropriate approach, equipment and techniques to identify the species and measure the	

				environmental variable and investigate distribution of chosen species.
Safely uses a range of practical equipment and materials	✓ Students must safely use the equipment and handle species ethically.	✓ Students must safely use the equipment and handle species ethically.	✓✓ Students minimise risks with minimal prompting and handle species ethically.	✓✓✓ Students must carry out a full risk assessment and minimise risks and handle species ethically.
Makes and records observations	✓ Students record distribution of species in specified ways.	✓ Students record distribution of species in specified ways.	✓ Students record distribution of species in specified ways.	✓✓✓ Students must choose the most effective way of recording observations.
Researches, references and reports	✓ Students compare results between students and identify reasons for differences.	✓✓ Students compare results between students and identify reasons for differences.	✓✓ Students compare results between students and identify reasons for differences.	✓✓✓ Students must research alternatives in order to plan their work. Reporting covers the planning, carrying out and an analysis of their results.

✓✓✓: Very good opportunity ✓✓: Good opportunity ✓: Slight opportunity ✕: No opportunity

---

A-level Biology example for required practical 12

**Investigation into the effect of a named environmental factor on the distribution of a given species:**

**Investigation into the distribution of dandelions in a lawn not treated with herbicide and a lawn treated with herbicide using a point quadrat frame**

## Student sheet

### Method

You are provided with the following:

- point quadrat frame (also called a point quadrat or pin frame)
- two tape measures.

You should read these instructions carefully before you start work.

1. Before going to the lawn, generate 10 sets of random co-ordinates.
2. Go to the herbicide-treated lawn. Make sure you can identify a dandelion plant by the shape of its leaves.
3. Lay out the tapes at right angles and place the point quadrat frame at the first set of random co-ordinates.
4. Use the pointers in the point frame to record the dandelions at this position.  
As each pointer is lowered, you must record any dandelion that is “hit” by the pointer, in your tally chart. Repeat this at the position determined by each set of random co-ordinates.
5. Take 100 pointer samples in each site, ie 10 placements of the point quadrat frame.
6. Repeat steps 1–5 at the lawn that has not been treated with herbicide.
7. Add up the total number of dandelion plants in each of the two sites.
8. Calculate the percentage cover of dandelions =  $\frac{\text{number of dandelion plants hit}}{\text{total number of pointer samples}} \times 100$

---

A-level Biology example for required practical 12

**Investigation into the effect of a named environmental factor on the distribution of a given species:**

**Investigation into the distribution of dandelions in a lawn not treated with herbicide and a lawn treated with herbicide using a point quadrat frame**

### Teacher notes

#### Materials

- point quadrat frame (also called a point quadrat or pin frame)
- two tape measures.

The investigation given is a very simple exercise that can be done just using a grass verge. Sampling experiments can be difficult in city centre environments but using a small patch of lawn and treating one half with lawn weed killer allows this investigation to be carried out.

The instructions given use a point quadrat but a square quadrat could be used and dandelions counted within the square.

#### Technical information

Any suitable lawn weed killer can be used. Instructions should be followed for safety and for time needed for effect to be seen. The weed killer may need to be used up to 2 weeks before the students do the investigation. Ask the groundsperson before doing this and carefully mark the area tested.

#### Additional notes

For square quadrats:

- Mark out the area with a tape measure.
- A quadrat split into 100 small squares can be used or other suitable sub-divided area.
- Count the number of sub-squares containing dandelions to get a cover ratio for the area of the quadrat.
- Repeat five times using random drops of the quadrat with area or generate points to place a corner of the quadrat at each area.

#### Alternative investigations

Similar methods of determining distribution can be used but the environmental factor can be changed eg light intensity (under trees and in the open), trampling (near and away from a path across grass land).

Suitable species to investigate for light intensity are ivy, nettle, bramble, dog's mercury, and for trampling plantain, daisy, dandelion.

---

## **Risk assessment**

Risk assessment and risk management are the responsibility of the centre.

## **Trialling**

The practical should be trialled before use with students.

## **Sample results**

A 50cm × 50cm quadrat was used. This was divided into 10cm squares. Trampling was assessed up to 10 metres away from a path using plantain as species. Quadrats were assessed every 1 metre from the centre of the path. Plantain distribution decreased rapidly after 1 metre from the path as it was out-competed by clover.

Photographs of an example set-up of this practical can be found in our set-up guide, which is available on our [A-level practicals page](#).

---

## Appendix: questions from teachers

---

The following questions were received during our end-of-year webinar: [practical skills endorsement – best practice one year in – July 2016](#), after the first year of the practical endorsement. The answers were provided by Catherine Witter, our Lead Practical Adviser.

### CPAC 1

**Can you test a large group of students by getting them to do written answers to questions for CPAC 1? Some pupils are expressing concern quietly that they feel like they are being continuously assessed because of the directed questioning - do you have any advice as to how to get around this?**

These two questions go together well. To pass CPAC 1, students need to follow the written instructions in the order written, be able to explain the reasons for doing each step and to collect a set of data that would be expected. If they complete some questions that secure independent access to the pass, that would be a good alternative to questioning them during the lesson.

**Do you have to have an accompanying checklist for CPAC 1, or is it enough to record what a student did incorrectly?**

When assessing students against CPAC 1, they need to be correctly carrying out the method steps in the right order. They also need to be able to explain why they are doing each step and to get a set of data that you would expect. Lots of teachers are choosing to keep a checklist to secure robust evidence against these assessment criteria but we will not ask to see it. Teachers can make records in whatever form they would like to, to allow them to make an accurate assessment.

**Is it wrong to do a 'dry demo' of a titration and then next lesson students carry out the titration. You go round and ask question and award CPAC 1?**

Teaching the general titration technique before expecting students to do it is good teaching, and this is the case before any assessment of CPAC is carried out. Dry demonstrating the practical method steps the lesson before they follow the written instructions is far less acceptable as the students need to independently show you that they can meet the pass standard in CPAC 1.

Circulating the laboratory and asking questions as they carry out the practical following written method steps provided will allow you to assess whether they can justify the reasons for carrying out each step. This is one of the assessment criteria for a pass in CPAC 1 and so would be good practice.

**Do students have to complete all CPAC 1 for all 12 practicals?**

To be endorsed for CPAC 1, your students will have to have consistently and routinely met the pass standard in CPAC 1. This may take three attempts; it may take all 12 attempts or more if you invite them to be assessed on your own level 3 challenge practical work. When you feel strongly, without question, that your students could follow a set of written instructions, justify the reasons for carrying out each step and collect a set of expected data totally independently of you – and when at university in their first year – then you are less likely to want to assess them on CPAC 1. They must be in this position at the end of the course and so only assessing CPAC 1 to this point in Year 12, for example, before stopping would not be recommended.

---

## CPAC 2

### **You mentioned that writing a method showed mastery of CPAC 1. I thought writing up a method related to CPAC 2 not CPAC 1?**

To demonstrate the pass standard for CPAC 2c, students must be able to write a method and determine which variables to change, control and measure.

To demonstrate the pass standard in CPAC 1, students must follow a written set of instructions provided, be able to explain why they are carrying out each step and collect expected data.

If students followed their own written method steps, providing that they have been carefully checked for both safety and to ensure they will generate expected data, that is a greater step towards total independence and hence a mastery of CPAC 1 is being developed.

Many teachers ask us “Is it okay if students plan a method but then I give them one to follow?”. Often the technician has not got the capacity (or sometimes the apparatus) to support several different methods being followed each time. Of course, we could support that and students would have access to the pass standard for CPAC 1 and 2c if given this task.

### **If a student is supposed to write their own method, why are they published by AQA in a handbook?**

Writing a method is a skill that students need to develop. Our example practical work will give students access to the apparatus and techniques that they will be examined on. There are a multitude of practical experiments that you could ask your students to write a set of method steps for, to allow them to access this CPAC 2c strand.

### **Can we assess some CPAC areas for a plan of an investigation (not a required practical) even if the students don't carry out the practical itself?**

Absolutely, yes. Aspects of CPAC 2 require students to be able to plan an investigation and if they do this successfully they would reach the pass standard in CPAC 2c. This can be set as a discrete task, you don't have to assess any other CPAC against the work they have done unless you choose to.

## CPAC 3

### **For CPAC 3, if a student has broken glassware and not attempted to clean it up, does that mean they have failed for that time?**

It is not as clear cut as that. For CPAC 3, students need to be able to identify major hazards, associated risks and control measures. During the practical lesson, they need to be observing the non-negotiable, practical specific safety measures.

Leaving broken glass on the desk or floor without dealing with it will certainly mean that the student has not reached pass standard on that occasion but will hopefully have partially met it. We would also like to think that teachers would report progress to students as them ‘not having shown evidence towards the pass on this occasion’ rather than the much stronger, negative word fail.

---

**Is it physics' fault if students complete CPAC 3 on a simple and safe experiment - they can still carry out a full risk assessment sheet - it may just be limited?**

Some practicals are much better vehicles to assess CPAC 3 as they present a greater challenge to students when identifying the major hazards, associated risks and control measures. There are practicals in physics that are more suitable. This includes required practicals 1, 2, 5 and 12 amongst others. All CPAC do not have to be assessed during every practical.

**Is 3a about planning and identifying the hazards and risks, and 3b about the 'doing'?**

Yes.

**I showed my class a video for the required practical where they make cyclohexene as we do not have enough fume cupboards. I assessed them based on their risk assessment and planning, is this okay despite them not carrying it out themselves?**

Assessing CPAC 3a in this way is absolutely fine for this practical although your students do need to complete a practical involving simple distillation. The cyclohexene preparation is a very routine example of how this technique can be used and refers to some important theory, which is why we have chosen it, but there are others. Please note that required practicals 5a or 5b can be used as alternatives as they both involve the use of simple distillation.

**CPAC 4**

**When assessing CPAC 4, you've said 'full headings' are required - is it sufficient to write, for example, "T/s" in Physics as a heading for time period measured in seconds? This was always the preferred method for the old ISAs when standard symbols were used. Would abbreviations include 'V' in place of voltage etc?**

There is a section in our practical handbooks to support teachers and their students to keep a record of data whilst carrying out practical work.

**Does 'biological drawing' relate to CPAC 4?**

Yes, this is a way of recording qualitative data. Please see one the 'Biological drawings guidance (CLEAPSS)' downloadable attachments on our [A-level practicals page](#) for support from CLEAPSS if that would be helpful in your own teaching.

**We couldn't get good results for Physics practical 4 (Young modulus) despite ordering two new sets of apparatus. Is it okay for pupils to have poor results and assess that data and still get credit?**

**Some of the Biology practicals have not worked through no fault of the students. Can we still assess them on a practical that did not give the expected results?**

To meet the pass standard for CPAC 4, students need to be able to design a suitable data table and record their data on collection. If the data was poor but is what you as their teacher would expect (as you also collected similar data) the students should not be penalised. If they then go on to process that data to formulate a conclusion, it would be a good exercise to then do some research and evaluate their data against a secondary source. This would open access to CPAC 5 in a very meaningful way.



---

**Students had previously carried out individual test-tube reactions on individual chemicals and were asked to record observations on an unknown, but they could not record all observations and they could not identify the unknown. Can I award CPAC4?**

From this information we would suggest they have not met the pass standard in CPAC 4. However, if they have carried out the chemical tests correctly after following a set of written instructions to get a set of data that you would expect, even if they could not independently record it, you may wish to give them credit for meeting the pass standard in CPAC 1 through this practical experience.

**Is it still acceptable for students to record data in tables CPAC 4b to the same number of decimal places or do they have to record to same number of significant figures?**

When recording data, students should record data to the correct resolution of the apparatus that they have used to collect that data. For example, a titration would be expected to be collected to two decimal places.

**We were informed by AQA that practicals involving fume hoods could include demonstrations by the teacher (rather than having each pupil in a class taking a turn at a fume hood). If the pupils record observations, is this correct?**

**Could the pupils use their research to inform how the teacher should best carry out the demonstration etc? Would this pass the CPAC?**

If you are only assessing CPAC 4 then this approach would be fine. If you had chosen to assess CPAC 1, demonstrations would clearly not be acceptable in the same lesson unless the student was struggling to meet the pass standard and you wanted to use demonstration at the time to improve their technique.

For the second part of your question I recommend using this research towards evidencing CPAC 3 and 5. Students could identify major hazards and associated risks to inform you how to carry out a safe demonstration. Their research could then be referenced fully.

**Is it appropriate (due to lack of equipment) for individual or pairs of students to make one measurement (eg count rate at one distance) and then combine all results to get class set? (We only have one GM tube and gamma source).**

If you can extend that to allow each individual to make a set of repeats of the same measurement, to allow them to independently collect and record a set of data, that would be more in keeping with the expected pass standard.

CPAC 5

**In CPAC 5: "sources of information are cited demonstrating that research has taken place supporting planning and conclusions". This seemed to imply that it will inform the practical they are doing rather than "inform further practical work". Is it the latter?**

The research element of CPAC 5 is to enable students to inform their past, current or future practical work. The potential for research use is large and spans: whether it is to support method planning, the apparatus to use, to compare the data collected to a secondary source or to support a conclusion or practical evaluation.

---

Students should be taught how to research most effectively and how to reference their sources to enable the source to be found again. Students should also have an understanding of the reliability of that resource of course as has been standard at GCSE level.

**Do students need to use a system for referencing? Our school asks for Harvard system across the board. If pupils reference but not use Harvard what would I mark them as?**

Our [CPAC student pen portraits](#) and [online practical endorsement training](#) show that the successful use of the Harvard system for example, would demonstrate mastery in this element of CPAC 5. If they did not do this but referenced the sources well to allow them to be found again, they would be meeting the pass standard.

**If they research a method and it is not feasible to do (ie not the one they would use in class) would they still pass that CPAC?**

**Do they have to carry out their plan or can they be given a pre-prepared plan AFTER the research phase and still get a positive assessment?**

Successful research to inform current or future practical work or to support evaluation of practical work has been done and, if referenced correctly, can be used for the assessment of CPAC 5. It is likely that teachers will give a written method of their own to follow for CPAC 1. This is absolutely fine as it is very likely that students will have chosen to use apparatus that may not be available in a routine school laboratory.

**I marked a titration practical and gave feedback. Referencing was not as good as I wanted. They asked if they could redo the write-up after feedback. Can I still award CPAC 5 for the second draft or is it only the first draft that counts?**

Students will have plenty of opportunity to access a pass on each of the CPAC areas as they go through the course. The first draft will count, the students concerned will have partially met CPAC 5, but they will have also understood what you require for referencing when they next meet some research work.

To meet the 'pass' standard, students must independently meet it consistently and routinely across all five competency areas by the end of the course. A second draft as described would mean that they hadn't independently achieved the CPAC 5b pass standard.

**On CPAC 5 it says 'Uses appropriate software and/or tools to process data and report findings'. Must they use software to pass this, or would drawing graphs by hand, using calculators to perform calculations suffice?**

A calculator is a tool and so, to gain evidence towards the pass for CPAC 5 this would suffice. However all the apparatus and techniques in the specification must be covered to ensure that your students have full access to the exam questions and so, if data can be collected and processed using dataloggers or Excel for example, that will be a good experience for your students to have.

---

**For the award of CPAC 5, is it okay for students to write up instructions for testing for ions after having carried out the experiments?**

If you are assessing CPAC 2, planning a method, then the way that you have described has not given them independent access to the task in hand as they have simply copied out the instructions given. They would not pass CPAC 5 on this occasion.

CPAC 5, Researches, references and reports involves data processing and referencing in addition to providing a structured report of what a student has done.

General queries

**What level of detail is required in terms of marking the key practical assessments to show evidence that students have met the required competency standards?**

Visiting advisers do not expect to see feedback given in any particular way. The majority of teachers are however using written feedback to communicate to their students how they might improve against the pass assessment criteria for any particular CPAC.

The adviser will be quality assuring teacher assessment of CPAC during their visit. If there is no feedback in student lab book records, it will be necessary for the adviser to question the subject teachers to ensure they can assess student work correctly.

**Have schools used a standard proforma for marking and assessment of student practical work?**

No. We will not be providing one as the [online practical endorsement training](#) clearly outlines what the pass standard looks like for all five CPAC areas. If you look on the website, you will find a teacher checklist that we have written, to crystallise the assessment criteria for pass. Teachers will then use those as guidance to think through in advance how the practical they are delivering will allow student access to those criteria.

We have provided an example set of 12 required practicals that together will ensure that students access all the apparatus and techniques they will need to be able to answer the practical questions in the written exams. Providing common proformas that all teachers mark to will, in effect, mean that we have gone backwards as teachers will then see them as 12 controlled assessments.

Teachers have the flexibility to assess CPAC as often as they want to, through any practical work of appropriate challenge they wish to. When teachers have fully grasped the key messages from the online training they will be in a position to assess CPAC accurately without the need for prescriptive mark schemes.

**When two worksheets are given in the practical handbook for a required practical, for example 5a and 5b in Chemistry, do we need to do both, or is only one is enough? With my group, I only did 5b which required more skills compared to 5a.**

In this case, 5a or 5b are optional, you were right to choose only one as they both gave the students the opportunity to experience simple distillation. You do need to ensure that you have covered the theory associated with both practical schedules.

However, required practicals 7 and 10 in Chemistry also each contain parts a and b. In the case of required practicals 7 and 10, these are not optional as they cover different apparatus and techniques and so students must complete practical work that covers those apparatus and techniques.

---

### **Will we have to send off the practical books to the AO?**

Your monitoring visit is to quality assure teacher assessment of CPAC. Once we are confident that the assessment criteria can be applied accurately you can endorse your students at the end of Year 13 without providing further evidence.

### **What are the most common reasons why schools have not been endorsed?**

Approximately 10% of schools and colleges who have already had their first monitoring visit require a second visit. Most commonly that is because subject teachers have not completed the necessary training to be able to apply the CPAC assessment criteria accurately. Tracking progress inaccurately is also a common reason.

Teachers are currently working very hard during the planning stage to enable students to access CPAC assessment regularly to enable students to eventually be able to 'consistently and routinely' meet the pass standard. Therefore if the planning documentation is not in place, more correspondence between the adviser and lead teacher will be required before the written report is finalised.

### **Do we notify AQA via e-AQA of the pass/not classified?**

Yes. The final date for reporting this to AQA is 15 May each academic year.

### **Can students pass the A-level if they are 'not classified' in the practical skills endorsement?**

Students will get a certificate in the A-level if they achieve a grade E or above overall. If they pass the practical skills endorsement and fail to achieve a grade, they will not receive a certificate. Students can therefore pass the A-level grades A\*–E if they are given a non-classified report in their practical skills.

### **What is the consequence for getting a 'not classified'? What are the consequences of failing our AQA practical audit for pupils?**

Higher education admissions tutors were a strong voice in A-level reform. Over time, AQA expects the practical endorsement reported to be a significant part of the student offer as universities get to grips with the changes to practical work.

We feel strongly that upwards of 95% of all students taking A-level sciences should be able to reach the pass standard and so pass the practical skills endorsement. Good science teachers will give their students many opportunities to hone their skills to ensure they can demonstrate them routinely and consistently.

Ofqual also plans to do some research. They will then be able to measure the impact of the changes to practical work assessment in the reformed specifications.

### **May the requirement of CPAC grades be classified in Distinction, Merit, Pass or Fail?**

The only two ways of reporting the practical skills endorsement are 'pass' or 'non-classified'. Most teachers will encourage their students to demonstrate a mastery of the five CPAC however.

---

**One of my students has missed their Biology TLC practical. We are also doing TLC in Chemistry - can they use evidence from the Chemistry practical for the Biology endorsement?**

We agree that the TLC technique is the same regardless of subject. Please be aware that students often find applying their knowledge difficult, so it may be best to encourage a catch-up opportunity.

**What is the best support we can give to our Chemistry technician who will have to do all practicals for A-levels and has no experience of A-level Biology or Physics?**

We have recently surveyed a large number of science technicians who support teachers delivering A-level science. We suggest that you give them a copy of the practical handbook for each subject, where they will find technician notes. They may also [contact one of our technician advisers directly](#).

If they are not already a member of a technician forum, that might be something to consider. Many technicians tap into a support network every day to share best practice.

**If we are only assessing 6–8 students in a lesson and only assessing one or two CPACs at a time and only tracking progress of the required practicals, there is a worry that we will not be able to get through all students and all CPACs isn't there?**

Yes. For schools and colleges who plan only to deliver the minimum number of required practicals, detailed in our practical handbooks, this is a risk if the approach in the question is taken.

Assessment of CPAC needs to be robust however and manageable in the practical lesson time if teachers are assessing CPAC 1,2a, 2b, 2d, 3b and 4.

Teachers who adopt this approach are therefore utilising homework and testing well to enable CPAC assessment. Many teachers are recycling legacy ISA and EMPA questions that fit with CPAC assessment and using those.

**I thought the *verbal feedback stamp* was out of date and frowned upon. Verbal feedback is usually always given. Surely a stamp does not confirm this? This seems to be here to tick certain boxes for school marking policy.**

Feedback can be given to students in many ways and teachers will take the approach no doubt that is most beneficial to their own students and the progress they make against the CPAC.

**Can students annotate their instruction sheets?**

Often this is a good way of assessing CPAC 2b. When students are carrying out their written instructions, they may identify ways to adjust the method slightly to enable more accurate data to be collected. If CPAC 1 is the focus of assessment then students can only access the pass standard if they have followed the written instructions independently, and so annotation reflecting whole class support prior to the start of the practical would clearly not be conducive.

**Can't we assess the 5 CPACs in each practical? Do you think an average student can meet all the CPAC standards in just the required practical work?**

If teacher plans reflect a rigorous assessment of each CPAC area before the end of the course then we would support completion of the minimum 12 required practicals as enough to allow students to reach a pass in the endorsement.

---

All five CPAC can be assessed in a single practical experience yes, but it is unlikely that it would be possible in the practical lesson time alone, even for a handful of students. Using homework and test questions and time, maybe a lesson before and/or after the practical lesson itself, would allow teachers to plan specific activities through which all five competencies could be assessed.

**When will the new tracker be available?**

Our new trackers are [available on our website](#) now.

**We have had an email saying an adviser is coming for our Biology A-level, but have not had communication regarding Chemistry. Will this be done on the same visit?**

**If we have already had a monitoring visit, would we get another one this year?**

Small centres, where each subject has fewer than 140 entries, have one visit to one subject for each exam series.

If successful, all three subjects at the school or college can endorse their students by 15 May of the year of A-level entry.

**How will you manage the monitoring visits to overseas schools such as ours?**

All international schools and colleges who offer our qualifications worldwide will be contacted to arrange monitoring of their lesson, teacher records and student records.

**Is a Physics example lab book on the AQA website? Is there anywhere centrally we can access each practical proforma already planned out like the one in worksheet 1 to save us all doing these?**

This is not the type of resource we typically produce, but on the [practical website page](#) you will find the webinar recording, slides and a number of other useful resources.

The required practicals in our specifications are suggested practicals that incorporate the apparatus and techniques that students will be examined on. We aim to keep practical work at A-level very open and so will not be creating or sharing a set of materials bespoke to each of the 12 practicals.

**Do you have additional support for teachers outside subject specialism? Do we have dates for the courses yet? Where can we find them?**

We have run a number of very successful courses in Manchester and London. These courses are aimed at offering teachers the opportunity to carry out the 12 required practicals for themselves with guidance about how to integrate CPAC assessment.

You will find details in the science section of the [CPD area of our website](#).

**Are you allowed to discuss which CPAC students need to work on more over the two-year course?**

Many teachers are sharing the tracking documents with their students to inform which CPAC needs more work if they are to reach the pass standard and their practical skills be endorsed at the

---

end of year 13. We have seen many students tracking their own progress, interacting with teacher written feedback after practical work has taken place.

**How do we carry out the distillation of ethanal practical given the recent safety concerns? We only have three fume cupboards.**

Our required practicals are only suggestions. We have worked hard to incorporate the apparatus and techniques for teachers but recognise that teachers may wish to choose an alternative practical that incorporates simple distillation. Practical 5a or 5b are alternatives as they both include simple distillation, so only one needs to be completed. However, these are not the only options.

**During the monitoring visit, do we have to show an endorsed practical?**

During the visit, your adviser will need to see students doing some practical work. It can be any practical work of level 3 challenge; it does not need to be one of our 12 required practicals. The purpose of the visit is to quality assure teacher assessment and so it might be helpful to assess some of the CPAC criteria whilst teaching the lesson, although this is not compulsory.

**Please could you advise how I can access the compulsory Lead Teacher online training? Do all teachers have to do the CPAC training and get their own certificate?**

The [practical page of our website](#) signposts all the help that you will need to deliver the A-level practical work and endorsement of your students. Our Lead Teacher training is only compulsory for the Lead Teacher as indicated, but in our experience many teachers are completing the training. Many technicians are also completing it.

**Do students need to complete a full write up for each practical?**

That is entirely up to you and depends on what you require from the exercise. You may have assessed one of the competency areas and just need evidence for that, for example?

All the required practicals can be assessed through exams and so should be written up in a form that students can revise from.

**If a student drops Physics, ie not studying in Year 13, do we need their documents for any reason?**

The CPAC are generic across all three sciences and so if this applies we would recommend passing their work across to their other science teachers to provide extra evidence.

You will no longer need to keep your own records of the CPAC progress in Physics if they are not likely to take it any further or move to another establishment to study it.

**Will the AQA examiner be looking at OCR courses at the centre? For example my Physics course is AQA, but Chemistry and Biology are OCR.**

The AQA adviser, if allocated an AQA subject visit by JCQ, will only monitor the work done by teachers and students in that specific subject.

---

**Do you have any tips to improve consistency of approach across the department?**

There are many subject teams that have a large number of teachers and there are strategies they are using to secure strong quality assurance. We would advise discussing the practical work first as a team, deciding which CPAC might be more suitable to assess in each one, then collectively deciding on the assessment criteria you would be looking for uniformly.

Lots of teachers are using checklists to help them to do this but we would not be asking to see them during a monitoring visit.

**CPAC5a and CPAC5b could be assessed in different experiments. How would that be recorded in the tracker?**

Our [sample endorsement trackers](#) have a tab for each of the required practicals and there are also tabs to record teacher assessments after other practical work has been completed.

Holistically, as long as the 'pass' standard has been met in CPAC 5 consistently and routinely, the student can be endorsed in CPAC 5.

**With Physics there are some practicals that require equipment we cannot afford to buy as class sets. How can we assess pupils for the CPACs for this?**

We understand that equipment, particularly in Physics, can be costly. Students must be able to demonstrate the five competencies independently to be endorsed and many schools and colleges are using a carousel in practical Physics lessons for example to ensure this can happen with limited apparatus.

**One of our students has transferred to us from another college which also used AQA. What are our responsibilities concerning CPACs?**

As the second centre, you have full responsibility for the assessment of CPAC and the endorsement of this student's practical skills. They must be assessed at 'pass' standard consistently and routinely across all five CPAC areas and so in Year 13 it is important that he or she has many opportunities to demonstrate this to you.

I recognise that this is difficult and potentially very time consuming and so I recommend contacting the previous college and asking for any related documentation to be passed across to you. The student file with their AS work will also be a useful starting point for evidence of CPAC 4 and 5 for example.

**You said many schools are doing more than 12 minimum practicals. I am struggling to fit in the 'official' practicals (recommended ones) but can I also include any other practicals?**

Absolutely. The CPAC can be assessed through any level 3 challenge practical work as well as through the minimum 12 required practicals. Many schools and colleges are doing more to allow the teaching of practical technique or access to new apparatus (for example) before assessing students on the use of them.

It is also likely that some of your students will need a few more attempts at demonstrating a competency area before they are routinely and consistently reaching the expected pass standard.



---

**For our visit next year, would you expect to see the work of students who are not continuing onto the full A-level?**

The endorsement of practical skills happens at the end of Year 13 and so we would not need to see the work of any students who have chosen not to continue with the subject. During your visit a sample of work will be chosen from all students who are in Year 12 or 13. Your adviser will explain how we do this when they make contact with you.

**We have class sizes of around 22. I would be interested in any approaches to carrying out necessary discussions with students during lesson time.**

Perhaps consider only assessing one student in each pair, for example, during the lesson or if your lesson time is short, only a third of the class on any one occasion. This will depend on how many practicals you plan to do over the duration of the course.

Students need to be able to explain the reasons for carrying out each step as they do a practical if you are assessing CPAC 1. Using an associated homework or test question to allow them to do this may also be a valuable way of assessing numbers of students at any one time and we understand that this may be your preference.

**If a student has achieved a CPAC during that particular practical, but not often enough for it to be 'consistently and routinely' - would this appear as green or amber on the endorsement tracker you've provided?**

The trackers are optional resources, not required documentation. There is a practical tab for each of the required practicals and if you are using these over time, you might expect the student to meet the pass standard in each CPAC more regularly. In other words, moving through the tabs if the colour green is seen for CPAC 1 more often than not, the student is consistently and routinely meeting the pass standard.

If you are using just one sheet to record all progress made towards the pass standard in CPAC 1, you will be moving from red to amber through to green as you assess students are meeting the pass standard more and more over time. Through your records you make a note of how many times that you have given them access to each competency.

**Can I tell students exactly what I will be looking for in order for them to pass a criterion before the practical?**

This is common. It is perfectly acceptable to 'scaffold' a task to allow them to access the assessment criteria for 'pass'. Over time, the withdrawal of that scaffolding will allow students to become independent, which is indicative of a mastery of the competency area.

**If a student doesn't meet the criteria for a particular part of a given CPAC, does this mean they fail their A-level? Also, if they do not meet the criteria for a given CPAC, are they allowed to repeat the practical?**

Each student must meet the pass standard in all parts of all five CPAC, consistently and routinely, before the end of the course in order for you to endorse their practical skills.

Repeating a practical will not stretch or challenge a student but if students are struggling to meet the pass in CPAC 1 for example, access to another level 3 practical would allow them to demonstrate their ability to follow a set of written instructions. This would be the next step.

---

**Will centres have the checklist that monitors have for their visit?**

All the paperwork our advisers use to support their visit can be found on the [practicals page on our website](#). Most of this is also emailed out to the lead teacher when the adviser makes first contact.

**I visited a school last week who said they had a record of the practicals and just ticks in the books. They were told more feedback was needed from the teachers. I'm feeling confused with the level of feedback you want us to give.**

The adviser who carries out your visit will look at a sample of student lab book records and will be able to see if the pass standard has been reached across the CPAC areas. This is more difficult for the quality assurance of CPAC 1, 2a, 2b, 2d, 3b without teacher feedback as they are competencies that are assessed during a lesson as students manipulate apparatus, work safely etc.

Feedback can be given in many forms and is essentially for the student to make progress. If the adviser finds their quality assurance exercise difficult, with the absence of feedback to students, they will question teachers on assessment criteria. We will support you as much as you need to become fully fluent with all the CPAC assessment criteria both through our online training and other associated resources that you will find on our [practical](#) page of the website.

**We were told that a hardback lab book was most appropriate during our monitoring visit. Can we continue to use exercise books or should we buy new ones?**

Hard backed books are more resilient to everyday use and are most portable over time but are not the only way to correctly house practical work.

**If a student completes a practical but does an incorrect calculation, can they still be awarded a CPAC? Also, if students are given an opportunity to correct the calculation is that work no longer acceptable for CPAC?**

This depends on what you have chosen to assess as only CPAC 5 involves calculation work and data processing. CPAC 1, for example, assesses a student's ability to follow a set of written instructions and so, in this case your student could still access 'pass' if they collected an expected set of data.

If your students were given help after their first attempt at a calculation and you regard it as too much help for them to independently correct the calculation, then it may be a partial pass if most but not all of the calculation steps were carried out correctly.

**For A-level Physics practical 12 (inverse square law for gamma radiation). Can I use UV Photo diode instead of gamma? A class set is cheaper to get than gamma. It works really well.**

For a student to be awarded the practical endorsement, he or she must gain experience in all of the apparatus and techniques in the specification. This is a compulsory part of the full A-level course. AT I demands the use of ionising radiation, including detectors. It is therefore a requirement for the full A-level. Additionally, one of the required practicals is an investigation of the inverse-square law for gamma radiation, so we would expect students to be familiar with that particular experiment and its underlying principles.

---

Using a UV photodiode or an LDR would reinforce general skills in the inverse square law, but by itself, it is not a suitable replacement for AT 1 or Practical 12 as students are not gaining experience of using a source of ionising radiation.

It is clear that students must have, either individually or in a group, hands-on experience of the use of ionising radiation including the use of detectors. This can be achieved using simple domestic equipment that emits ionising radiation. Such equipment could consist of thorium-coated gas mantles or commercial smoke detectors of the type that include an alpha emitter.

In terms of a follow-up investigation, this could include a practical simulation involving radiation from the electromagnetic spectrum other than gamma radiation. It could also include spreadsheet analysis of raw data obtained from a gamma experiment, but which had not necessarily been obtained within the centre itself.

## Get help and support

Visit our website for information, guidance, support and resources at [aqa.org.uk/7402](https://www.aqa.org.uk/7402)

You can talk directly to the Science subject team

E: [alevelscience@aca.org.uk](mailto:alevelscience@aca.org.uk)

T: 01483 477 756