

GCSE EDEXCEL MATHS

Aiming for Grade 5

REVISION BOOKLET



Name: _____

Contents

	Page:
Number:	
Standard form	3
Laws of indices	6
Rounding and estimating	8
Bounds	10
Algebra:	
Expand and factorise quadratics	12
Rearrange formulae	15
Linear simultaneous equations	17
Graphical inequalities	21
Shape, Space and Measure:	
Angles in parallel lines and polygons	26
Loci and construction	31
Transformations	36
Pythagoras' Theorem	41
SOH CAH TOA	45
Area and perimeter of sectors	48
Volume and surface area of cones and spheres	50
Length, area and volume similarity (LAV)	53
Data Handling:	
Averages from tables	56
Sampling	59
Probability:	
Probability trees	63
Ratio and Proportion:	
Proportion	67
Calculating with fractions	71
Percentages – compound interest	75
Percentages – reverse	77

Standard Form

Things to remember:

- $a \times 10^b$



$1 \leq a < 10$

1. A floppy disk can store 1 440 000 bytes of data.
(a) Write the number 1 440 000 in standard form.

.....
(1)

A hard disk can store 2.4×10^9 bytes of data.

- (b) Calculate the number of floppy disks needed to store the 2.4×10^9 bytes of data.

.....
(3)
(Total 4 marks)

2. A nanosecond is 0.000 000 001 second.
(a) Write the number 0.000 000 001 in standard form.

.....
(1)

A computer does a calculation in 5 nanoseconds.

- (b) How many of these calculations can the computer do in 1 second?
Give your answer in standard form.

.....
(2)
(Total 3 marks)

3. (a) (i) Write 40 000 000 in standard form.
(ii) Write 3×10^{-5} as an ordinary number.

.....
.....
(2)

- (b) Work out the value of
 $3 \times 10^{-5} \times 40\,000\,000$
Give your answer in standard form.

.....
(2)
(Total 4 marks)

4. Work out $(3.2 \times 10^5) \times (4.5 \times 10^4)$
Give your answer in standard form correct to 2 significant figures.

.....
(Total 2 marks)

5. (a) Write the number 40 000 000 in standard form.

.....
(1)

- (b) Write 1.4×10^{-5} as an ordinary number.

.....
(1)

- (c) Work out
 $(5 \times 10^4) \times (6 \times 10^9)$
Give your answer in standard form.

.....
(2)
(Total 4 marks)

6. Write in standard form

- (a) 456 000

.....
(1)

- (b) 0.00034

.....
(1)

- (c) 16×10^7

.....
(1)
(Total 3 marks)

7. (a) Write 5.7×10^{-4} as an ordinary number.

.....
(1)

- (b) Work out the value of $(7 \times 10^4) \times (3 \times 10^5)$
Give your answer in standard form.

.....
(2)
(Total 3 marks)

8. (a) Write 30 000 000 in standard form.

 (1)

- (b) Write 2×10^{-3} as an ordinary number.

 (1)
(Total 2 marks)

9. (a) (i) Write 7900 in standard form.

 (ii) Write 0.00035 in standard form.

 (2)

- (b) Work out $\frac{4 \times 10^3}{8 \times 10^{-5}}$
 Give your answer in standard form.

 (2)
(Total 4 marks)

10. Work out

$$\frac{2 \times 2.2 \times 10^{12} \times 1.5 \times 10^{12}}{2.2 \times 10^{12} - 1.5 \times 10^{12}}$$
 Give your answer in standard form correct to 3 significant figures.

.....
(Total 3 marks)

11. (a) Write 6.4×10^4 as an ordinary number.

 (1)

- (b) Write 0.0039 in standard form.

 (1)

- (c) Write 0.25×10^7 in standard form.

 (1)
(Total 3 marks)

Laws of Indices

Things to remember:

$$a^m \times a^n = a^{m+n}$$

$$a^{-n} = \frac{1}{a^n}$$

$$a^m \div a^n = a^{m-n}$$

$$(a^m)^n = a^{mn}$$

$$a^0 = 1$$

$$a^{\frac{m}{n}} = \sqrt[n]{a^m}$$

Questions:

1. (a) Simplify $m^5 \div m^3$

.....
(1)

- (b) Simplify $5x^4y^3 \times x^2y$

.....
(2)

(Total for Question is 3 marks)

2. Write these numbers in order of size.
Start with the smallest number.

5^{-1}

0.5

-5

5^0

.....
(Total for Question is 2 marks)

3. Write down the value of $125^{\frac{2}{3}}$

.....
(Total for question is 1 mark)

4. (a) Write down the value of 10^{-1}

.....
(1)

- (b) Find the value of $27^{\frac{2}{3}}$

.....
(2)
(Total for Question is 3 marks)

5. (a) Find the value of 5^0
.....
(1)

(b) Find the value of $27^{1/3}$
.....
(1)

(c) Find the value of 2^{-3}
.....
(1)
(Total for Question is 3 marks)

6. (a) Write down the value of $27^{1/3}$
.....
(1)

(b) Find the value of $27^{-1/2}$
.....
(2)
(Total for Question is 3 marks)

7. (a) Write down the value of $64^{1/2}$
.....
(1)

(b) Find the value of $\left(\frac{8}{125}\right)^{-2/3}$
.....
(2)
(Total for question = 3 marks)

8. (a) Write down the value of 6^0
.....
(1)

(b) Work out $64^{2/3}$
.....
(2)
(Total for question = 3 marks)

Estimating Calculations

Things to remember:

- Round each number to one significant figure first (e.g. nearest whole number, nearest ten, nearest one decimal place) – this earns you one mark.
- Don't forget to use BIDMAS.

Questions:

1. Work out an estimate for $\frac{3.1 \times 9.87}{0.509}$

.....
(Total for Question is 3 marks)

2. Margaret has some goats.
The goats produce an average total of 21.7 litres of milk per day for 280 days.
Margaret sells the milk in $\frac{1}{2}$ litre bottles.
Work out an estimate for the total number of bottles that Margaret will be able to fill with the milk.
You must show clearly how you got your estimate.

.....
(Total for Question is 3 marks)

3. Work out an estimate for the value of $\frac{89.3 \times 0.51}{4.8}$

.....
(Total for Question is 2 marks)

4. Work out an estimate for $\sqrt{4.98 + 2.16 \times 7.35}$

.....
(Total for question = 3 marks)

5. A ticket for a seat at a school play costs £2.95
There are 21 rows of seats.
There are 39 seats in each row.
The school will sell all the tickets.
Work out an estimate for the total money the school will get.

£

(Total for Question is 3 marks)

6. Jayne writes down the following

$$3.4 \times 5.3 = 180.2$$

Without doing the exact calculation, explain why Jayne's answer cannot be correct.

.....
.....
.....

(Total for question is 1 mark)

Bounds

Things to remember:

- Calculating bounds is the opposite of rounding – they are the limits at which you would round up instead of down, and vice versa.

Questions:

1. A piece of wood has a length of 65 centimetres to the nearest centimetre.

(a) What is the least possible length of the piece of wood?

.....
(1)

(b) What is the greatest possible length of the piece of wood?

.....
(1)

(Total for Question is 2 marks)

2. Chelsea's height is 168 cm to the nearest cm.

(a) What is Chelsea's minimum possible height?

..... cm
(1)

(b) What is Chelsea's maximum possible height?

..... cm
(1)

(Total for Question is 2 marks)

3. Dionne has 60 golf balls.

Each of these golf balls weighs 42 grams to the nearest gram.

Work out the greatest possible total weight of all 60 golf balls.

Give your answer in kilograms.

..... kg
(Total for Question is 3 marks)

4. The length, L cm, of a line is measured as 13 cm correct to the nearest centimetre.

Complete the following statement to show the range of possible values of L

..... $\leq L <$
(Total for question is 2 marks)

5. Jim rounds a number, x , to one decimal place.
The result is 7.2
Write down the error interval for x .

.....
(Total for question = 2 marks)

6. A pencil has a length of 17 cm measured to the nearest centimetre.
(a) Write down the least possible length of the pencil.

.....
(1)

- (b) Write down the greatest possible length of the pencil.

.....
(1)

(Total for Question is 2 marks)

Expand and Factorise Quadratics

Things to remember:

- Use FOIL (first, outside, inside, last) or the grid method (for multiplication) to expand brackets.
- For any quadratic $ax^2 + bx + c = 0$, find a pair of numbers with a sum of b and a product of ac to factorise.

Questions:

1. Expand and simplify $(m + 7)(m + 3)$

.....
(Total for question = 2 marks)

2. (a) Factorise $6 + 9x$

.....
(1)

(b) Factorise $y^2 - 16$

.....
(1)

(c) Factorise $2p^2 - p - 10$

.....
(2)

(Total for Question is 4 marks)

3. Solve, by factorising, the equation $8x^2 - 30x - 27 = 0$

.....
(Total for Question is 3 marks)

4. Factorise $x^2 + 3x - 4$

.....
(Total for question is 2 marks)

5. Write $x^2 + 2x - 8$ in the form $(x + m)^2 + n$ where m and n are integers.

.....
(Total for question is 2 marks)

6. (a) Expand $4(3x + 5)$

.....
(1)

(b) Expand and simplify $2(x - 4) + 3(x + 5)$

.....
(2)

(c) Expand and simplify $(x + 4)(x + 6)$

.....
(2)

(Total for Question is 5 marks)

7. (a) Factorise $x^2 + 5x + 4$

.....
(2)

(b) Expand and simplify $(3x - 1)(2x + 5)$

.....
(2)

(Total for Question is 4 marks)

8. (a) Expand $3(2 + t)$ (1)
- (b) Expand $3x(2x + 5)$ (2)
- (c) Expand and simplify $(m + 3)(m + 10)$

..... (2)
(Total for Question is 5 marks)

9. (a) Factorise $x^2 + 7x$ (1)
- (b) Factorise $y^2 - 10y + 16$
- * (c) (i) Factorise $2t^2 + 5t + 2$ (2)

- (ii) t is a positive whole number.
 The expression $2t^2 + 5t + 2$ can never have a value that is a prime number.
 Explain why.

.....

.....

.....

..... (3)
(Total for Question is 6 marks)

Rearranging Formulae

Things to remember:

- Firstly decide what needs to be on its own.
- Secondly move all terms that contain that letter to one side. Remember to move all terms if it appears in more than one.
- Thirdly separate out the required letter on its own.

Questions:

7. Make u the subject of the formula

$$D = ut + kt^2$$

$$u = \dots\dots\dots$$

(Total 2 marks)

2. (a) Solve $4(x + 3) = 6$

$$x = \dots\dots\dots$$

(3)

- (b) Make t the subject of the formula $v = u + 5t$

$$t = \dots\dots\dots$$

(2)
(Total 5 marks)

3. (a) Expand and simplify
 $(x - y)^2$

$$\dots\dots\dots$$

(2)

- (b) Rearrange $a(q - c) = d$ to make q the subject.

$$Q = \dots\dots\dots$$

(3)
(Total 5 marks)

4. Make x the subject of
 $5(x - 3) = y(4 - 3x)$

$x = \dots\dots\dots$
(Total 4 marks)

5. $P = \frac{n^2 + a}{n + a}$
Rearrange the formula to make a the subject.

$A = \dots\dots\dots$
(Total 4 marks)

6. $\frac{x}{x + c} = \frac{p}{q}$
Make x the subject of the formula.

$X = \dots\dots\dots$
(Total 4 marks)

Linear Simultaneous Equations

Things to remember:

1. Scale up (if necessary)
2. Add or subtract (to eliminate)
3. Solve (to find x)
4. Substitute (to find y) (or the other way around)

Questions:

- *1. The Singh family and the Peterson family go to the cinema.
The Singh family buy 2 adult tickets and 3 child tickets.
They pay £28.20 for the tickets.
The Peterson family buy 3 adult tickets and 5 child tickets.
They pay £44.75 for the tickets.
Find the cost of each adult ticket and each child ticket.

(Total for question = 5 marks)

2. Solve the simultaneous equations

$$3x + 4y = 5$$

$$2x - 3y = 9$$

$$x = \dots\dots\dots$$

$$y = \dots\dots\dots$$

(Total for Question is 4 marks)

3. Solve the simultaneous equations

$$4x + 7y = 1$$

$$3x + 10y = 15$$

$x = \dots\dots\dots$

$y = \dots\dots\dots$

(Total for Question is 4 marks)

7. Solve

$$2x + 3y = \frac{2}{3}$$

$$3x - 4y = 18$$

$x = \dots\dots\dots$

$y = \dots\dots\dots$

(Total for Question is 4 marks)

7. Solve the simultaneous equations

$$4x + y = 25$$

$$x - 3y = 16$$

$x = \dots\dots\dots$

$y = \dots\dots\dots$

(Total for Question is 3 marks)

7. Solve the simultaneous equations

$$3x - 2y = 7$$

$$7x + 2y = 13$$

$x = \dots\dots\dots$

$y = \dots\dots\dots$

(Total for Question is 3 marks)

7. A cinema sells adult tickets and child tickets.
The total cost of 3 adult tickets and 1 child ticket is £30
The total cost of 1 adult ticket and 3 child tickets is £22
Work out the cost of an adult ticket and the cost of a child ticket.

adult ticket £.....

child ticket £.....

(Total for question = 4 marks)

- *8. Paper clips are sold in small boxes and in large boxes.
There is a total of 1115 paper clips in 4 small boxes and 5 large boxes.
There is a total of 530 paper clips in 3 small boxes and 2 large boxes.
Work out the number of paper clips in each small box and in each large box.

(Total for Question is 5 marks)

Graphical Inequalities

Things to remember:

- Use a table of values if you need to help you draw the linear graphs.
- Use a solid line for \geq or \leq , and a dotted line for $>$ or $<$.
- Test a coordinate ((0, 0) is easiest) to work out which side of the line to shade.

Questions:

1. (a) Solve the inequality $5e + 3 > e + 12$

.....
(2)

- (b) On the grid, shade the region defined by the inequality $x + y > 1$

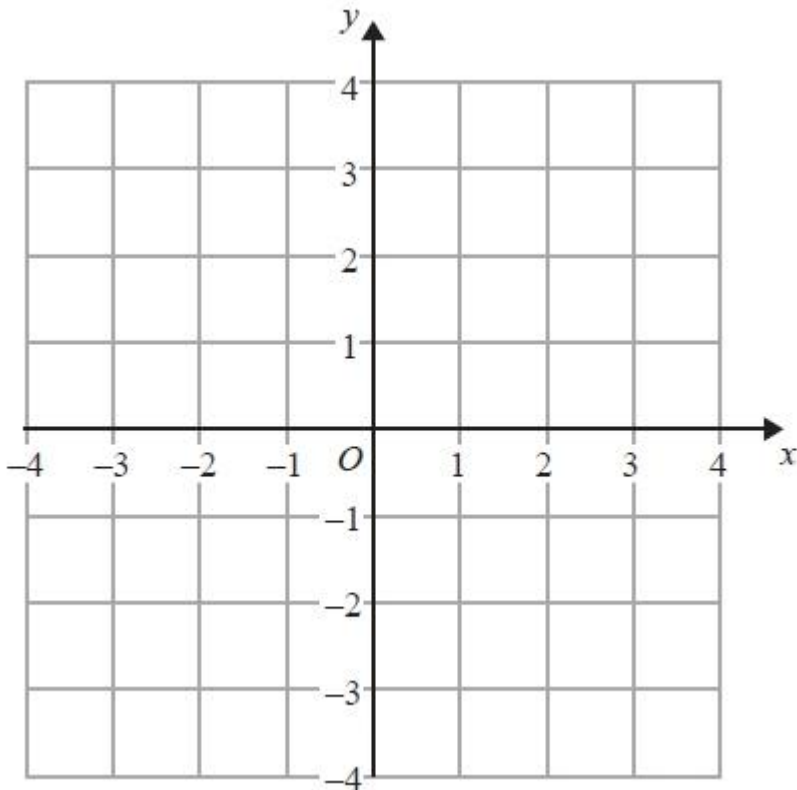

(2)

(Total for Question is 4 marks)

2. The lines $y = x - 2$ and $x + y = 10$ are drawn on the grid.

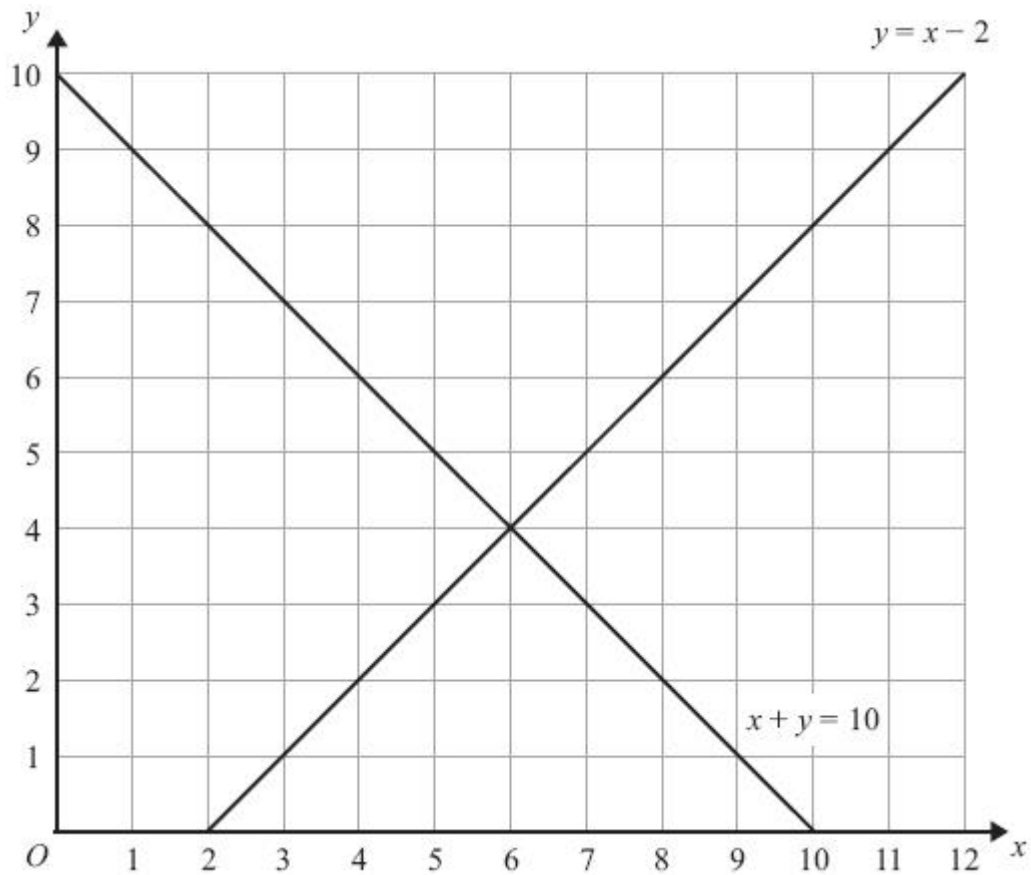

On the grid, mark with a cross (×) each of the points with integer coordinates that are in the region defined by

$$\begin{aligned} y &> x - 2 \\ x + y &< 10 \\ x &> 3 \end{aligned}$$

(Total for Question is 3 marks)

3. On the grid below, show by shading, the region defined by the inequalities

$$x + y < 6$$

$$x > -1$$

$$y > 2$$

Mark this region with the letter R.

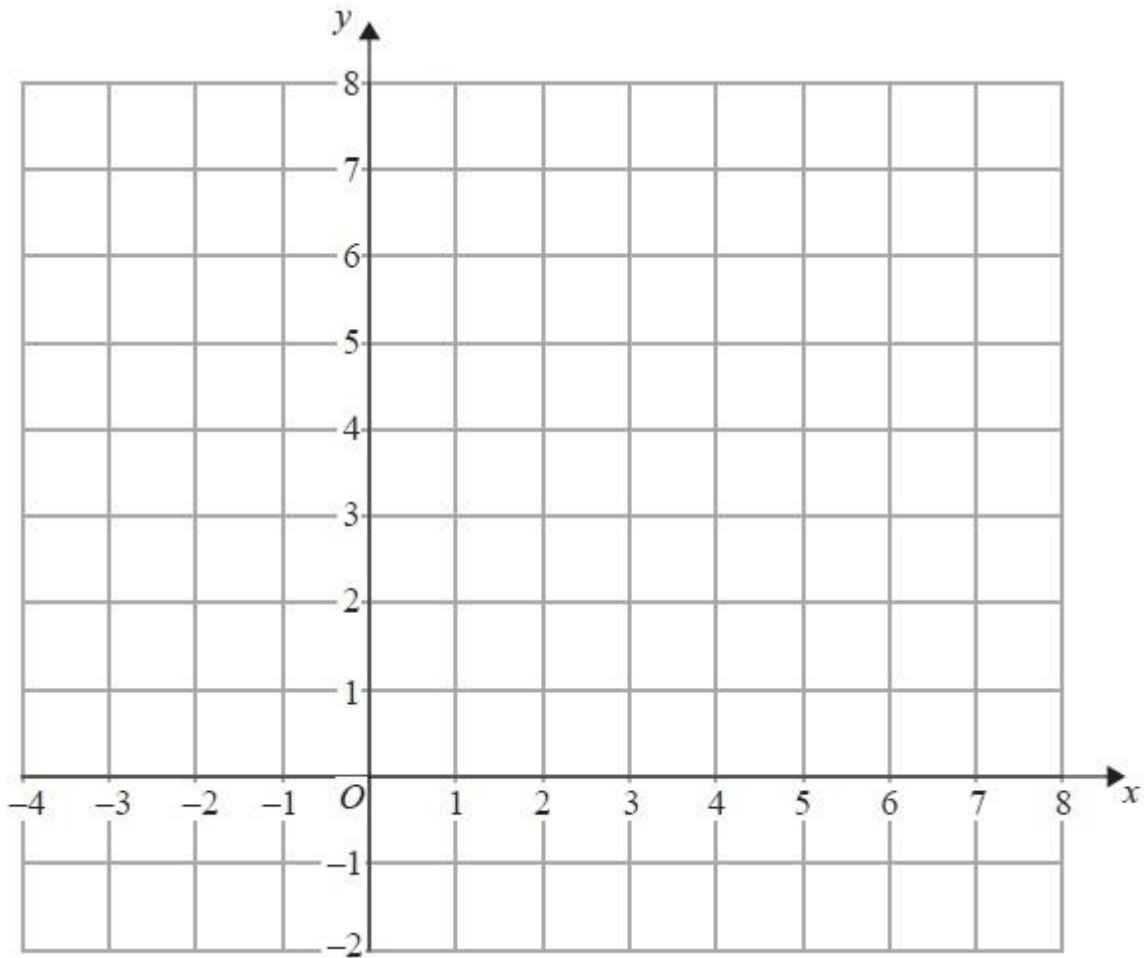

(Total for Question is 4 marks)

4. (a) Given that x and y are integers such that

$$3 < x < 7$$

$$4 < y < 9$$

$$\text{and } x + y = 13$$

find all the possible values of x .

.....
(2)

- (b) On the grid below show, by shading, the region defined by the inequalities

$$y \geq -1 \quad y \leq 4 - x \quad y \leq 3x - 1$$

Mark this region with the letter R.

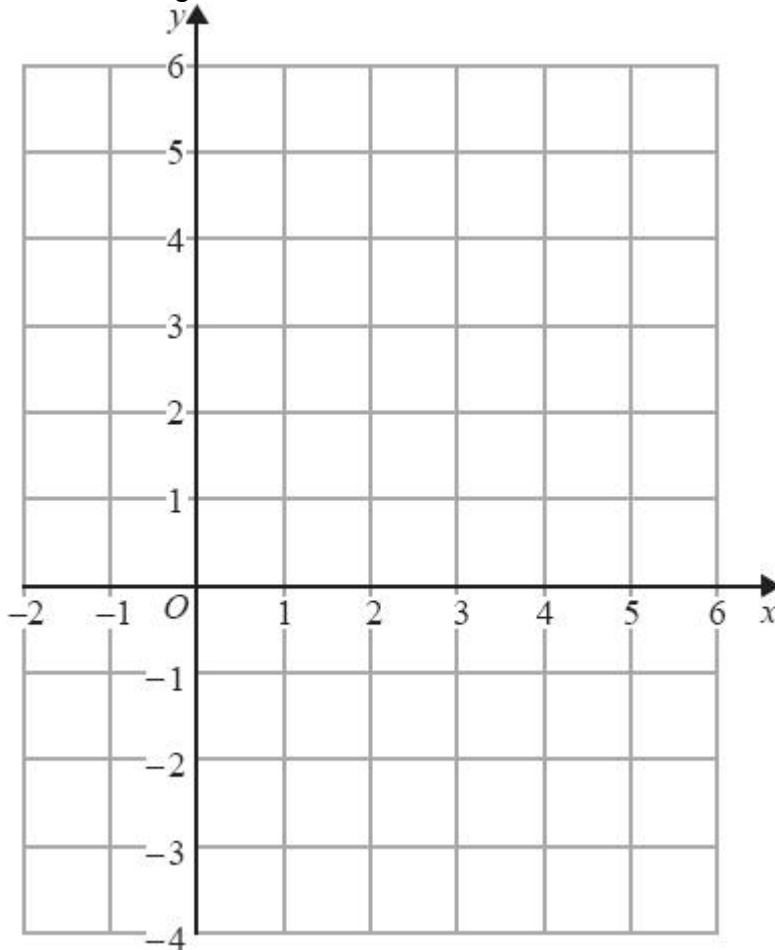

(4)
(Total for question = 6 marks)

5. On the grid show, by shading, the region that satisfies all three of the inequalities

$$x + y < 7$$

$$y < 2x$$

$$y > 3$$

Label the region **R**.

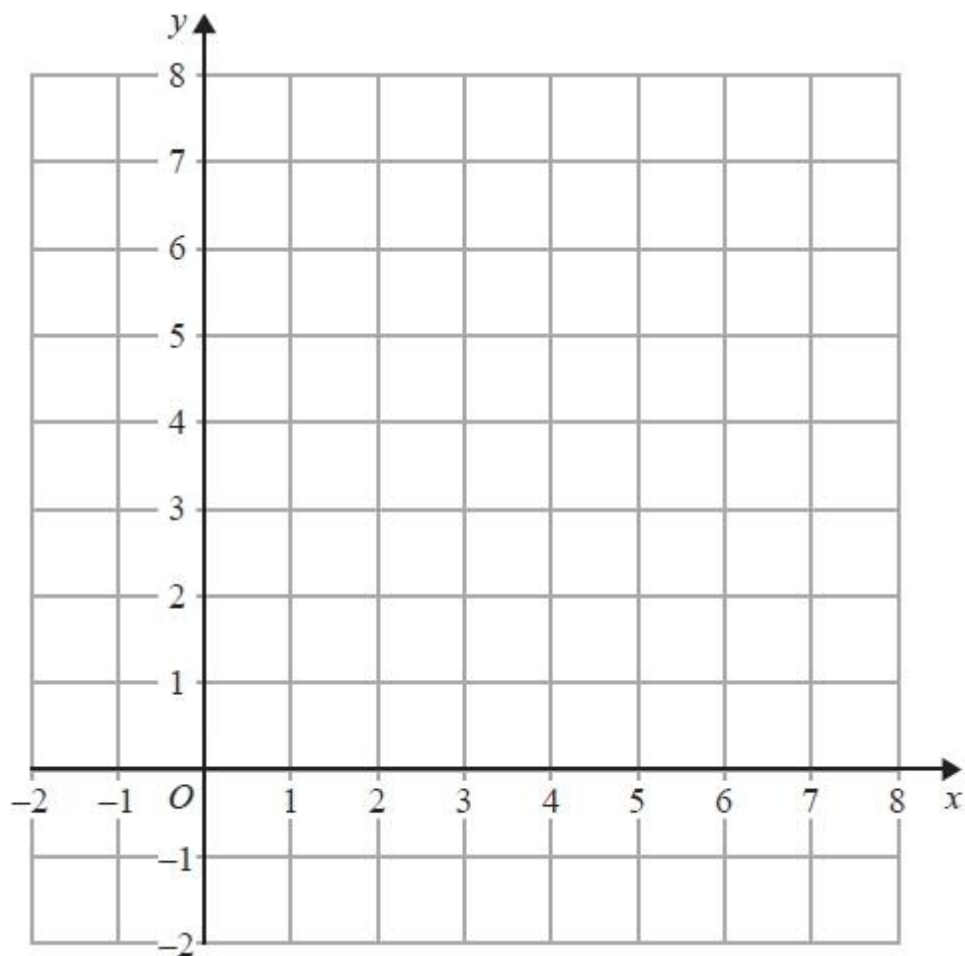

(Total for question = 4 marks)

Angles in parallel lines and polygons

Things to remember:

- Angles in a triangle sum to 180°
- Angles on a straight line sum to 180°
- Angles around a point sum to 360°
- Vertically opposite angles are equal
- Alternate angles are equal
- Corresponding angles are equal
- Supplementary angles sum to 180°
- An exterior and an interior angle of a polygon sum to 180°
- An exterior angle = $360^\circ \div$ number of sides

Questions:

1. PQ is a straight line.

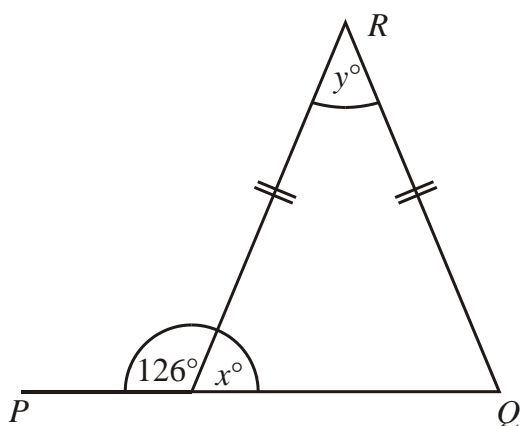

Diagram **NOT**
accurately drawn

- (a) Work out the size of the angle marked x° .

.....^o
(1)

- (b) (i) Work out the size of the angle marked y° .

.....^o

- (ii) Give reasons for your answer.

.....
.....

(3)
(Total 4 marks)

2. Triangle ABC is isosceles, with $AC = BC$.
 Angle $ACD = 62^\circ$.
 BCD is a straight line.

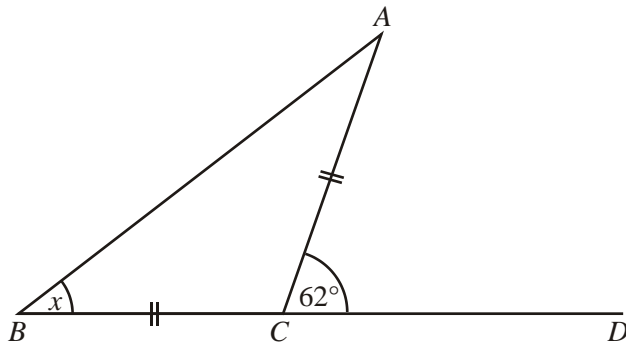

Diagram **NOT**
 accurately drawn

- (a) Work out the size of angle x .

$x = \dots\dots\dots^\circ$
(2)

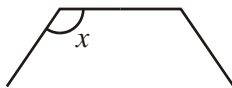

Diagram **NOT**
 accurately drawn

- The diagram shows part of a **regular** octagon.
 (b) Work out the size of angle x .

$x = \dots\dots\dots^\circ$
(3)
(Total 5 marks)

- 3.

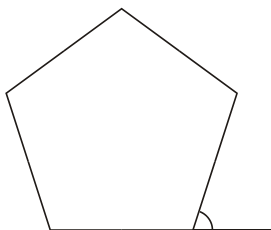

Diagram **NOT**
 accurately drawn

- (a) Work out the size of an exterior angle of a regular pentagon.

$\dots\dots\dots^\circ$
(Total 2 marks)

4. $ABCD$ is a quadrilateral.

Diagram **NOT**
accurately drawn

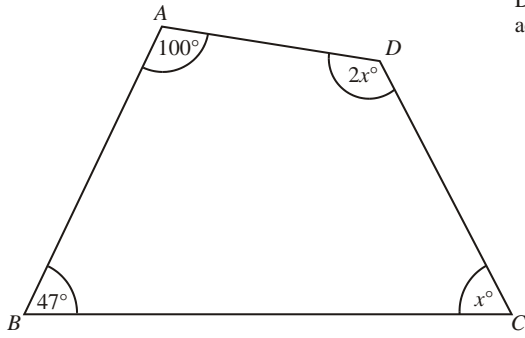

Work out the size of the largest angle in the quadrilateral.

.....^o
(Total 4 marks)

5.

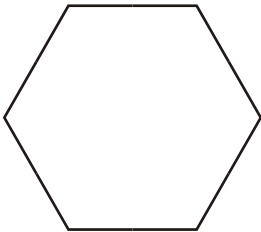

Diagram **NOT**
accurately drawn

Calculate the size of the exterior angle of a regular hexagon.

.....^o
(Total 2 marks)

6. DE is parallel to FG .

Diagram **NOT**
accurately drawn

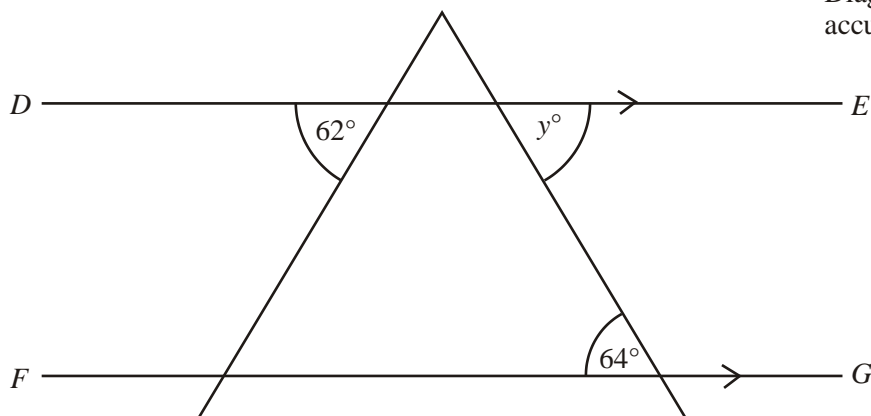

Find the size of the angle marked y° .

.....^o
(Total 1 mark)

7. BEG and CFG are straight lines.
 ABC is parallel to DEF .
Angle $ABE = 48^\circ$.
Angle $BCF = 30^\circ$.

Diagram **NOT**
accurately drawn

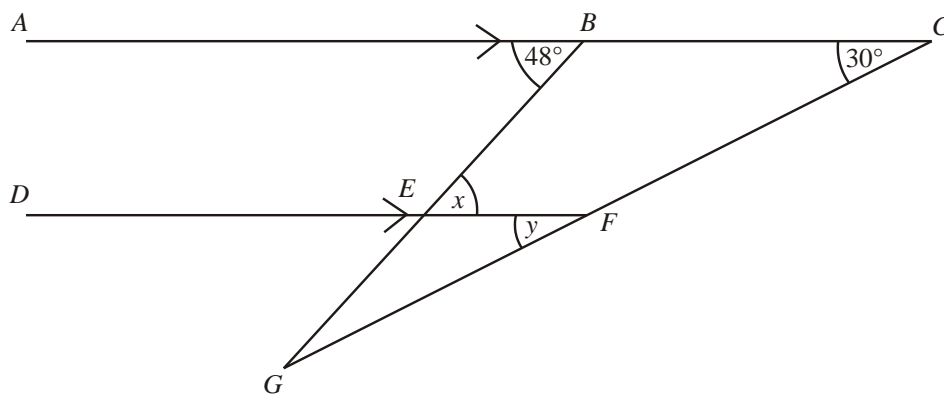

- (a) (i) Write down the size of the angle marked x .

$x = \dots\dots\dots^\circ$

- (ii) Give a reason for your answer.

.....
(2)

- (b) (i) Write down the size of the angle marked y .

$y = \dots\dots\dots^\circ$

- (ii) Give a reason for your answer.

.....
(2)

(Total 4 marks)

8. The diagram shows the position of each of three buildings in a town.
 The bearing of the Hospital from the Art gallery is 072° .
 The Cinema is due East of the Hospital.
 The distance from the Hospital to the Art gallery is equal to the distance from the Hospital to the Cinema.

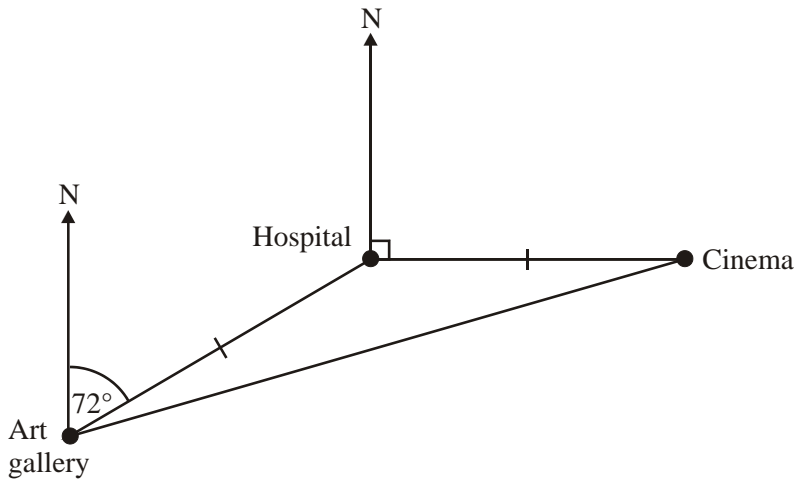

Diagram **NOT** accurately drawn

Work out the bearing of the Cinema from the Art gallery.

.....^o
(Total 3 marks)

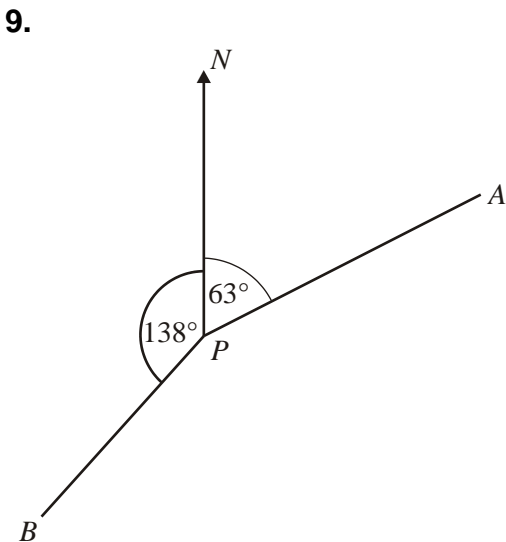

Diagram **NOT** accurately drawn

- Work out the bearing of
- (i) B from P ,
 - (ii) P from A ,

.....^o
^o
(Total 3 marks)

Loci and Construction

Things to remember:

- The question will always say “use ruler and compasses” – if you don’t you will lose marks.
- Sometimes there are marks for drawing something that is almost right, so always have a guess if you can’t remember.
- Bisector means “cut in half”

Questions:

1.



Use ruler and compasses to **construct** the perpendicular bisector of the line segment AB .
You must show all your construction lines.

(Total for question = 2 marks)

2. The diagram shows the plan of a park.

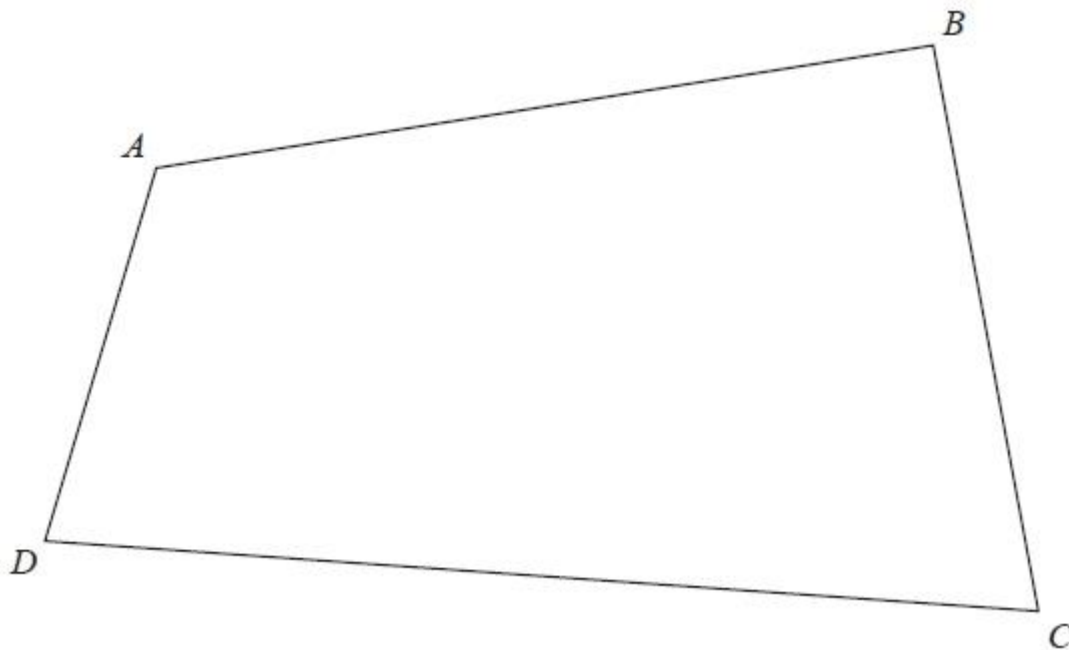

Scale: 1 cm represents 100 m

A fountain in the park is equidistant from A and from C. The fountain is exactly 700 m from D.

On the diagram, mark the position of the fountain with a cross (×).

(Total for question = 3 marks)

3. Here is a scale drawing of an office.
The scale is 1 cm to 2 metres.



A photocopier is going to be put in the office.

The photocopier has to be closer to B than it is to A.

The photocopier also has to be less than 8 metres from C.

Show, by shading, the region where the photocopier can be put.

(Total for question = 3 marks)

4. Use ruler and compasses to **construct** the perpendicular from point C to the line AB . You must show all your construction lines.

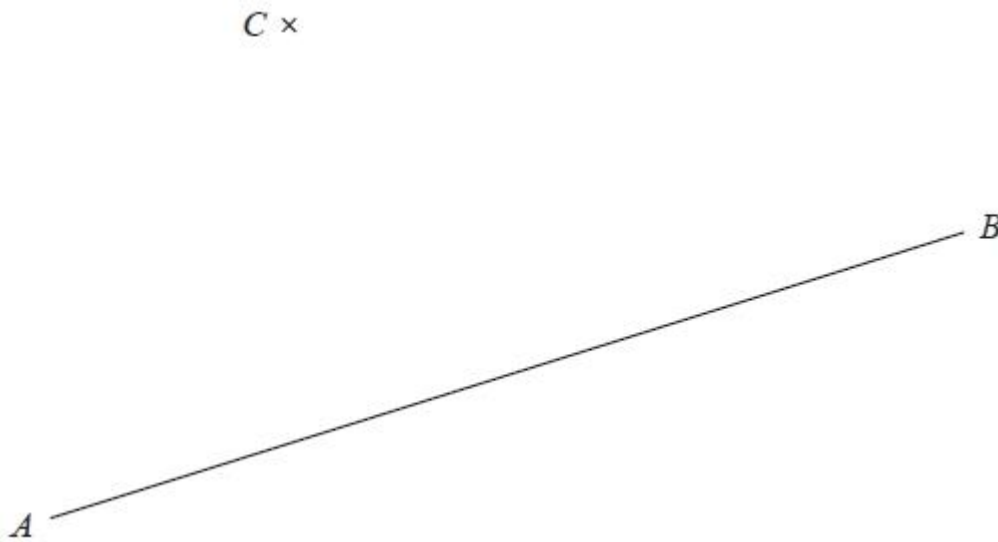

(Total for Question is 2 marks)

5. The diagram shows a garden in the shape of a rectangle. The scale of the diagram is 1 cm represents 2 m.



Scale: 1 cm represents 2 m

Irfan is going to plant a tree in the garden.

The tree must be

more than 3 metres from the patio

and more than 6 metres from the centre of the pond.

On the diagram, shade the region where Irfan can plant the tree.

(Total for Question is 3 marks)

6. The diagram shows a scale drawing of a garden.

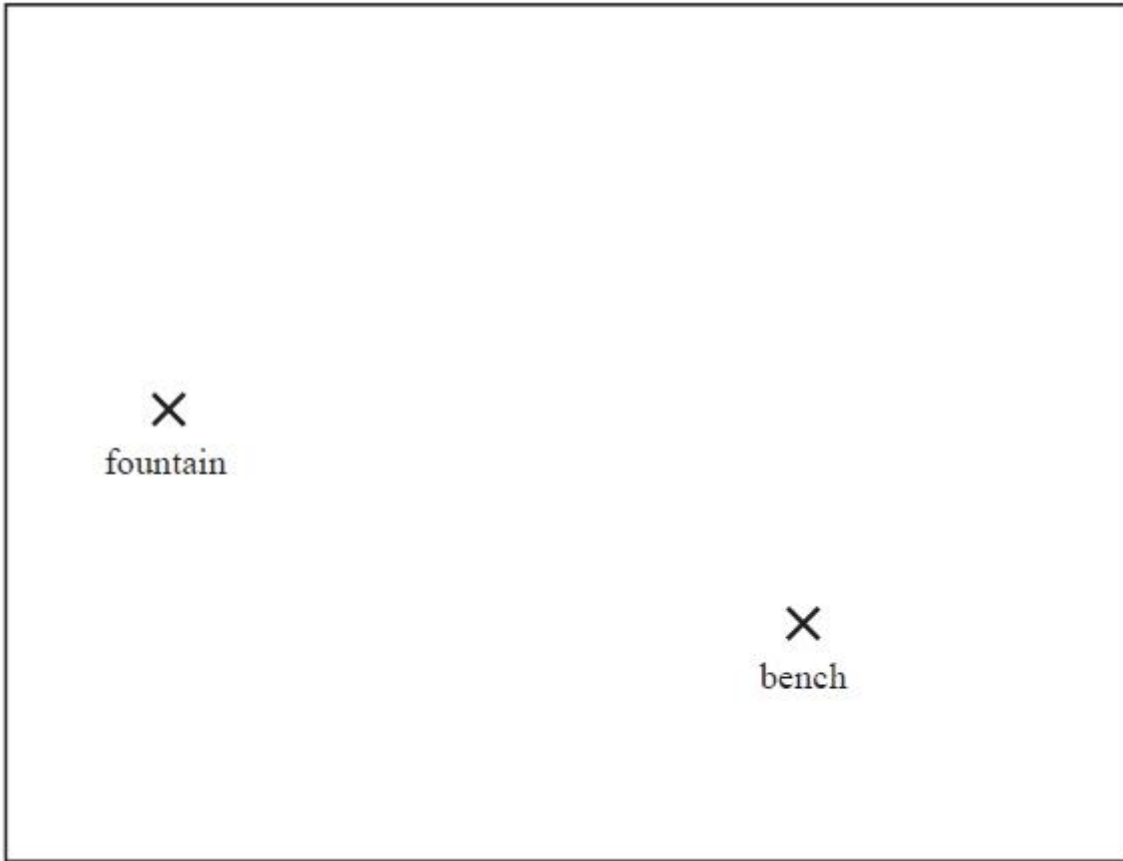

Scale: 1 centimetre represents 2 metres

Haavi is going to plant a tree in the garden.

The tree must be

less than 7 metres from the fountain,

less than 12 metres from the bench.

On the diagram show, by shading, the region in which Haavi can plant the tree.

(Total for question = 3 marks)

7. The diagram shows the positions of two shops, *A* and *B*, on a map.

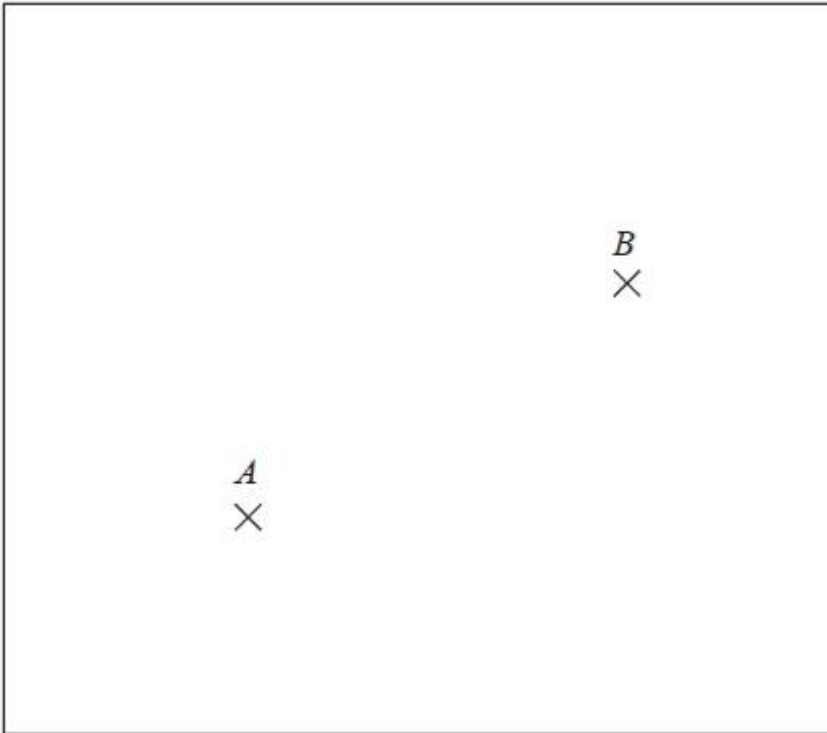

The scale of the map is 1 cm represents 5 km.

Yannis wants to build a warehouse.

The warehouse needs to be

less than 10 km from *A*,

less than 20 km from *B*.

Show by shading where Yannis can build the warehouse.

(Total for Question is 3 marks)

Transformations

Things to remember:

- Reflection – the shape is flipped in a mirror line
- Rotation – the shape is turned a number of degrees, around a centre, clockwise or anticlockwise
- Translation – the shape is moved by a vector $\begin{pmatrix} x \\ y \end{pmatrix}$
- Enlargement – the shape is made bigger or smaller by a scale factor from a centre.

Questions:

1.

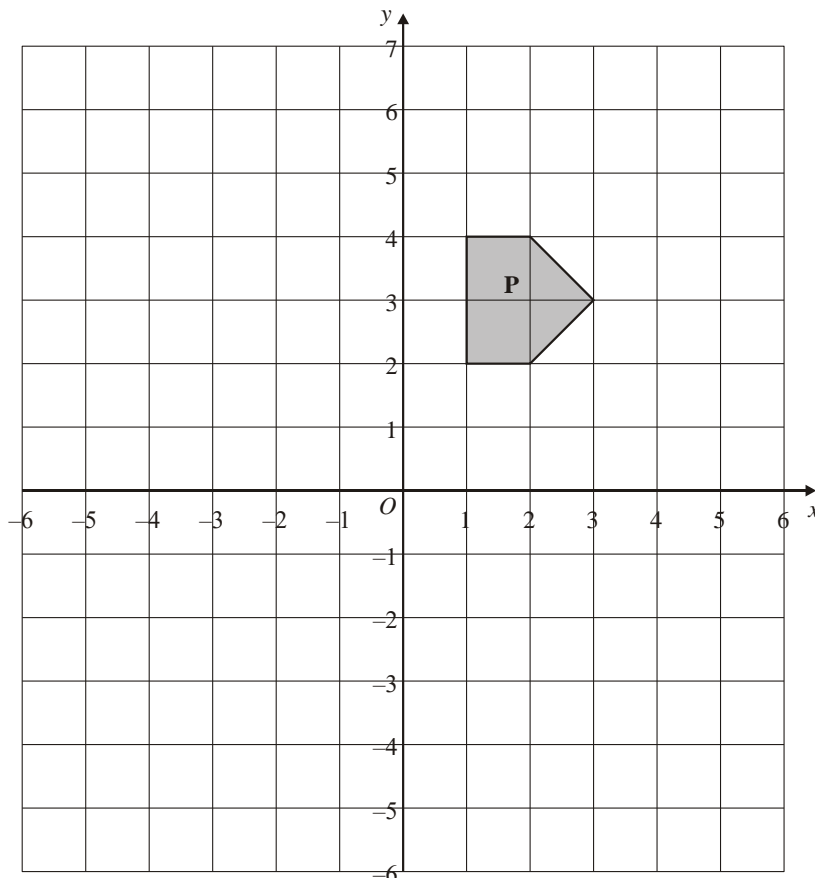

(a) On the grid, rotate the shaded shape **P** one quarter turn anticlockwise about **O**. Label the new shape **Q**.

(3)

(b) On the grid, translate the shaded shape **P** by 2 units to the right and 3 units up. Label the new shape **R**.

(1)

(Total 4 marks)

2.

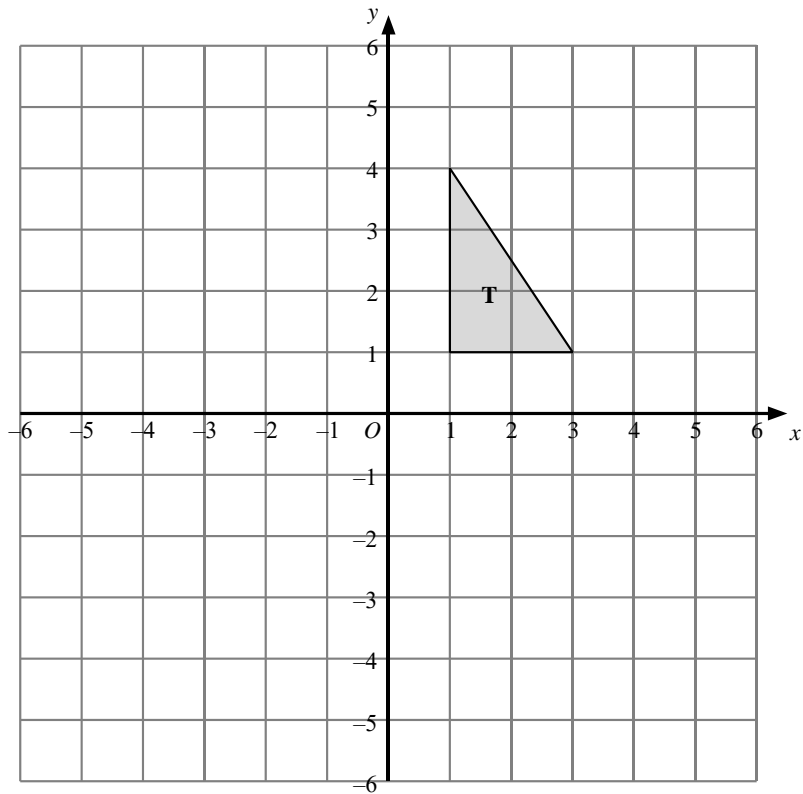

Triangle **T** has been drawn on the grid.

- (a) Reflect triangle **T** in the y -axis.
Label the new triangle **A**.
- (b) Rotate triangle **T** by a half turn, centre O .
Label the new triangle **B**.

(1)

(2)

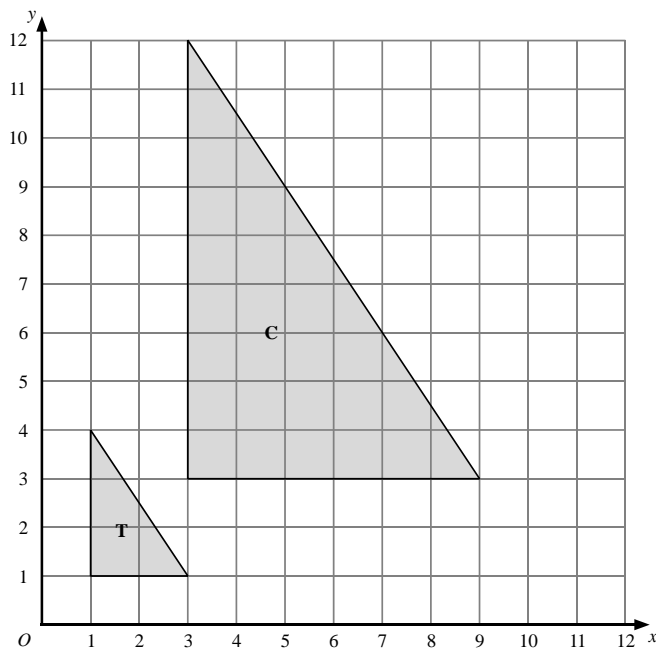

- (a) Describe fully the single transformation which maps triangle **T** onto triangle **C**.

.....

(3)

(Total 6 marks)

3.

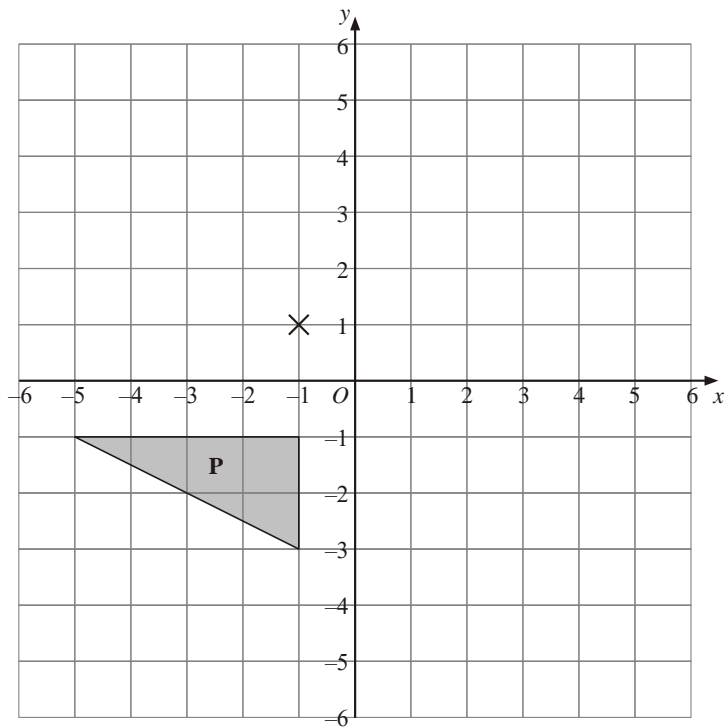

(a) Rotate triangle **P** 180° about the point $(-1, 1)$.
Label the new triangle **A**.

(2)

(b) Translate triangle **P** by the vector $\begin{pmatrix} 6 \\ -1 \end{pmatrix}$.
Label the new triangle **B**.

(1)

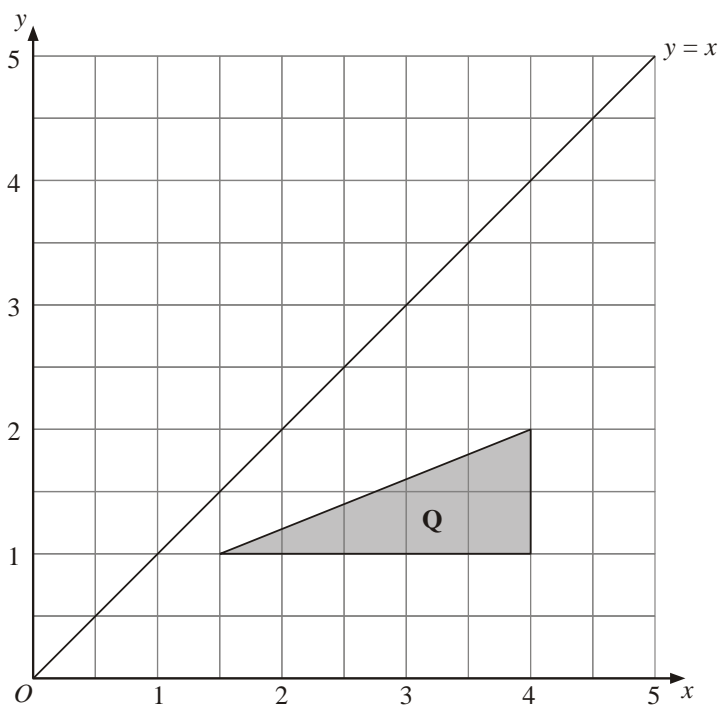

(c) Reflect triangle **Q** in the line $y = x$.
Label the new triangle **C**.

(2)

(Total 5 marks)

4.

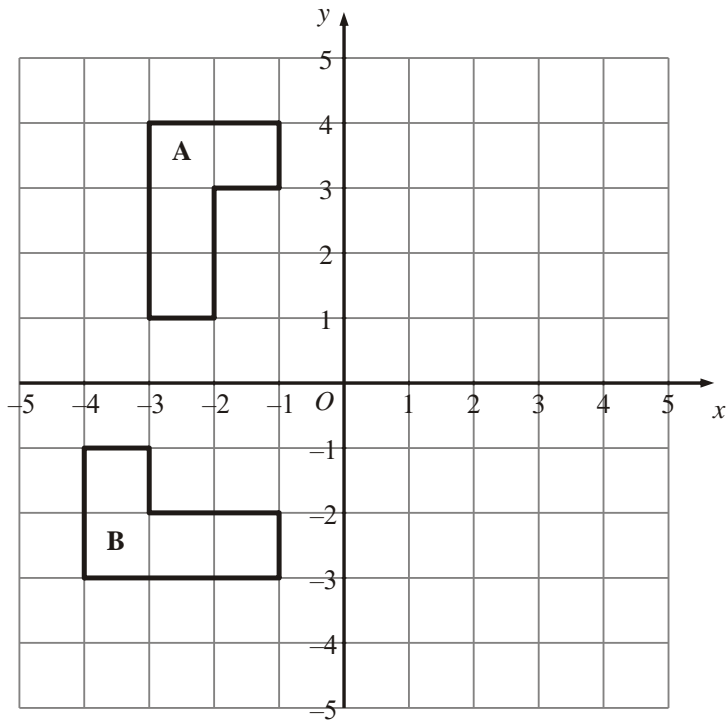

(a) Reflect shape **A** in the **y** axis.

(2)

(b) Describe fully the **single** transformation which takes shape **A** to shape **B**.

.....

(3)

(Total 5 marks)

5.

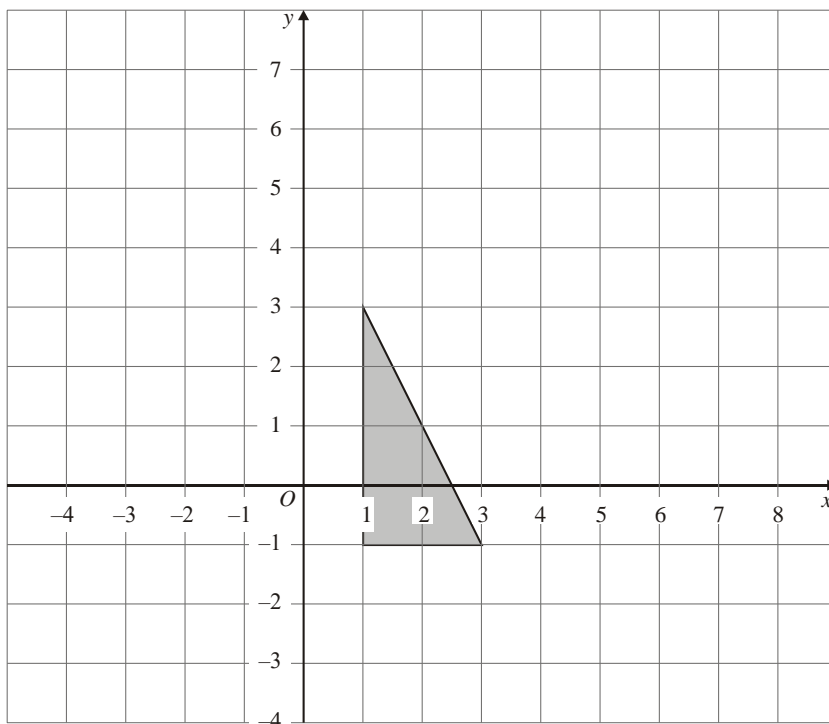

Enlarge the shaded triangle by a scale factor 2, centre 0.

(Total 3 marks)

6.

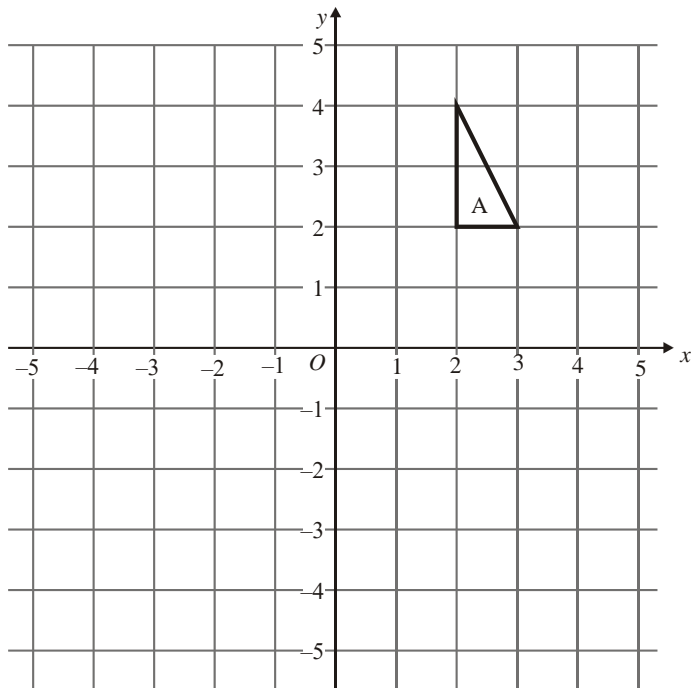

(a) On the grid, rotate triangle **A** 180° about **O**.
Label your new triangle **B**.

(2)

(b) On the grid, enlarge triangle **A** by scale factor $\frac{1}{2}$, centre **O**.
Label your new triangle **C**.

(3)

(Total 5 marks)

7.

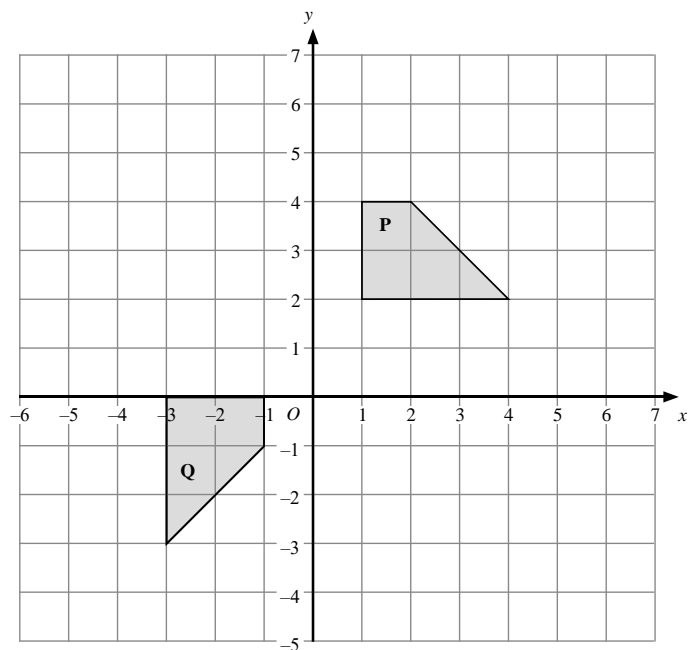

Describe fully the single transformation that will map shape **P** onto shape **Q**.

.....

.....

(Total 3 marks)

Pythagoras' Theorem

Things to remember:

- $a^2 + b^2 = c^2$
- First you've got to square both sides of the triangle.
- Then decide whether to add or subtract.
- Finish off with a square root.
- Make sure you round your answer correctly.

Questions:

1. $ABCD$ is a trapezium.
Diagram NOT accurately drawn
 $AD = 10$ cm
 $AB = 9$ cm
 $DC = 3$ cm
Angle $ABC =$ angle $BCD = 90^\circ$
Calculate the length of AC .
Give your answer correct to 3 significant figures.

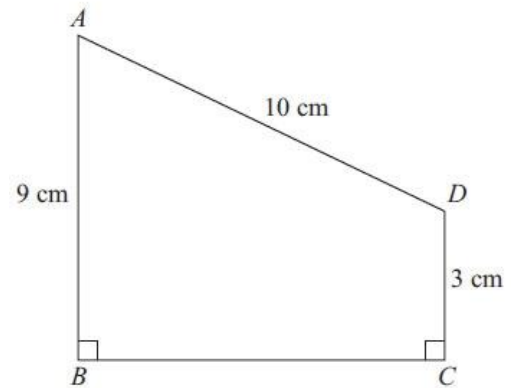

..... cm
(Total for Question is 5 marks)

2. Diagram NOT accurately drawn
Calculate the length of AB .
Give your answer correct to 1 decimal place.

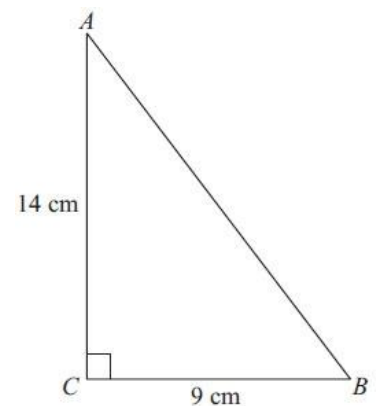

..... cm
(Total for Question is 3 marks)

3. Triangle ABC has perimeter 20 cm.
 $AB = 7$ cm.
 $BC = 4$ cm.
 By calculation, deduce whether triangle ABC is a right-angled triangle.

(Total for question = 4 marks)

4. The diagram shows a cuboid $ABCDEFGH$.

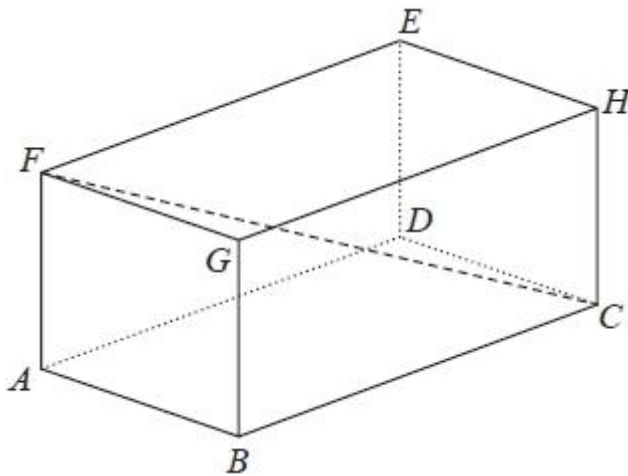

$AB = 7$ cm, $AF = 5$ cm and $FC = 15$ cm.
 Calculate the volume of the cuboid.
 Give your answer correct to 3 significant figures.

..... cm³
 (Total for question is 4 marks)

5. Here is a right-angled triangle.
Diagram NOT accurately drawn

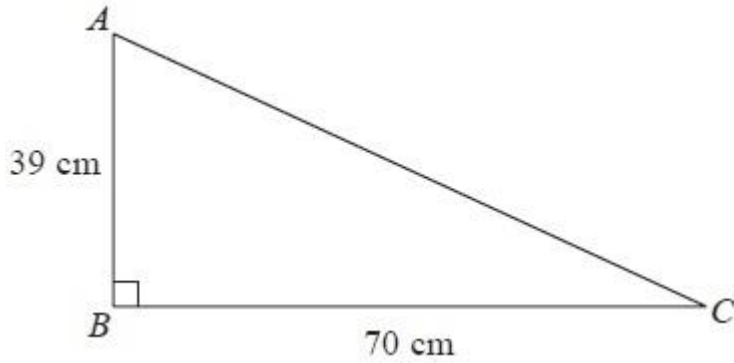

Work out the length of AC.
Give your answer correct to 1 decimal place.

..... cm
(Total for Question is 3 marks)

6. ABC is a right-angled triangle.
AC = 6 cm
AB = 13 cm

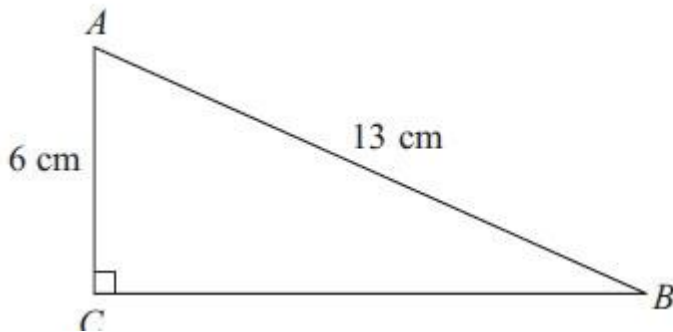

Diagram NOT
accurately drawn

Work out the length of BC.
Give your answer correct to 3 significant figures.

..... cm
(Total for Question is 3 marks)

7. $ABCD$ is a square with a side length of $4x$
 M is the midpoint of DC .
 N is the point on AD where $ND = x$
 BMN is a right-angled triangle.

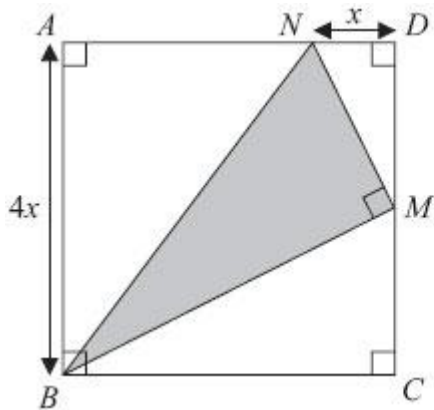
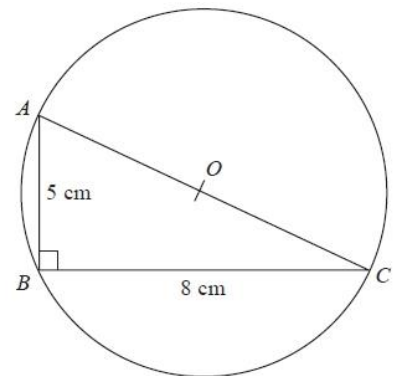

Diagram NOT accurately drawn

Find an expression, in terms of x , for the area of triangle BMN .
 Give your expression in its simplest form.

.....
 (Total for Question is 4 marks)

8. Diagram NOT accurately drawn
 ABC is a right-angled triangle.
 A , B and C are points on the circumference of a circle centre O .
 $AB = 5$ cm
 $BC = 8$ cm
 AOC is a diameter of the circle.
 Calculate the circumference of the circle.
 Give your answer correct to 3 significant figures.



..... cm
 (Total for question = 4 marks)

Trigonometry – SOH CAH TOA

Things to remember:

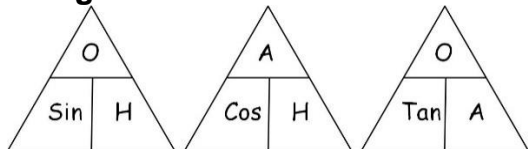

1. Label your sides first, you'll need O, H and A...
2. Choose if you need SOH, CAH or TOA...
3. Cover the one you need with your thumb,
4. Write the equation,
5. Solve it, then you're done!

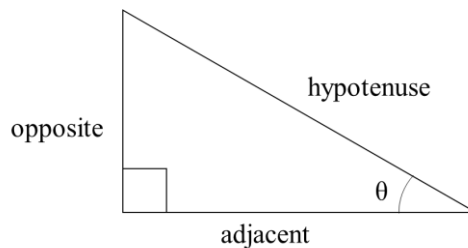

Questions:

1. The diagram shows triangle ABC .
 $BC = 8.5$ cm.
 Angle $ABC = 90^\circ$.
 Angle $ACB = 38^\circ$.
 Work out the length of AB .
 Give your answer correct to 3 significant figures.

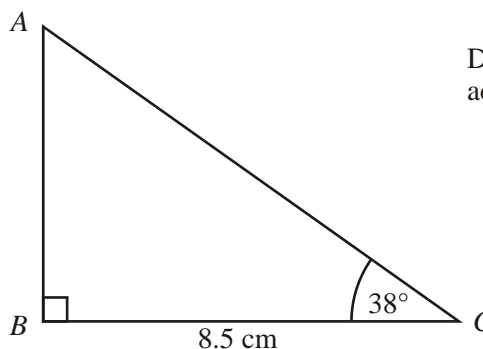

Diagram **NOT** accurately drawn

..... cm
(Total 3 marks)

2. PQR is a triangle.
 Angle $PQR = 90^\circ$.
 $PQ = 12.5$ cm.
 $QR = 5$ cm.
 Calculate the value of x .
 Give your answer correct to 1 decimal place.

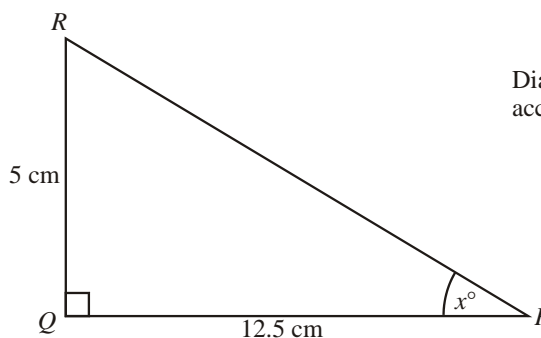

Diagram **NOT** accurately drawn

.....^o
(Total 3 marks)

3. A lighthouse, L , is 3.2 km due West of a port, P .
A ship, S , is 1.9 km due North of the lighthouse, L .

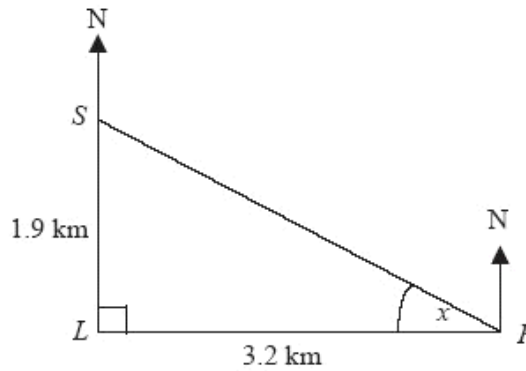

Diagram **NOT** accurately drawn

- (a) Calculate the size of the angle marked x .
Give your answer correct to 3 significant figures.

..... °
(3)

- (b) Find the bearing of the port, P , from the ship, S .
Give your answer correct to 3 significant figures.

..... °
(1)
(Total 4 marks)

4. (a) Calculate the size of angle a in this right-angled triangle.
Give your answer correct to 3 significant figures.
Diagram **NOT** accurately drawn

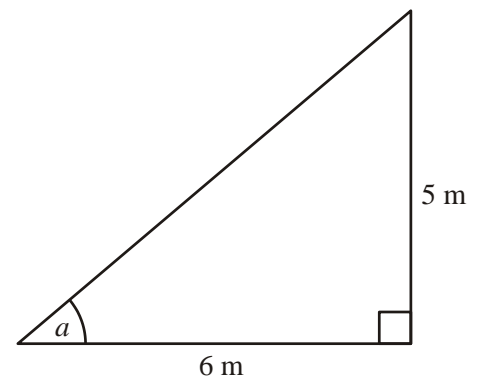

..... °
(3)

- (b) Calculate the length of the side x in this right-angled triangle.
Give your answer correct to 3 significant figures.
Diagram **NOT** accurately drawn

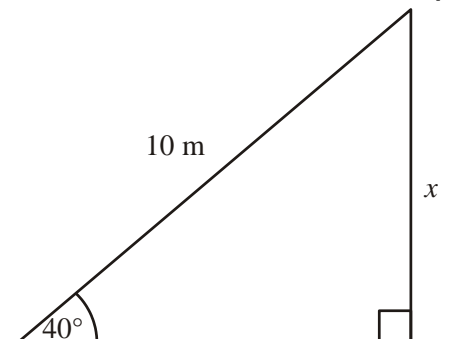

..... cm
(3)
(Total 6 marks)

5. Diagram **NOT** accurately drawn
 Work out the value of x .
 Give your answer correct to 1 decimal place.

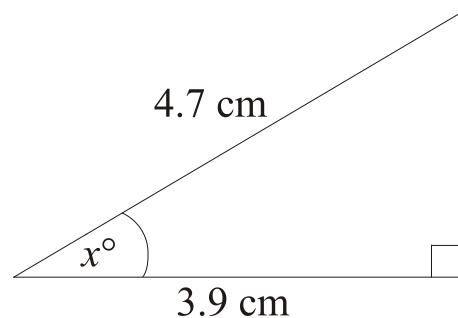

..... °
(Total 3 marks)

6. Diagram **NOT** accurately drawn
 $AC = 12$ cm.
 Angle $ABC = 90^\circ$.
 Angle $ACB = 32^\circ$.
 Calculate the length of AB .
 Give your answer correct to 3 significant figures.

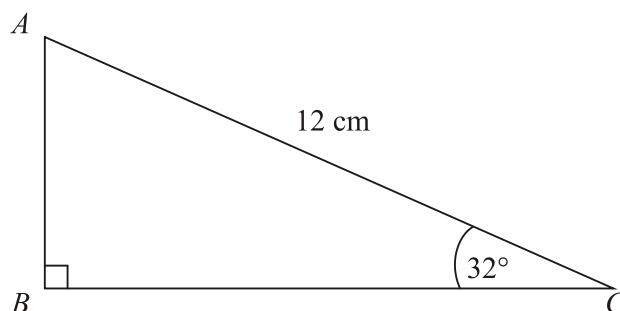

..... cm
(Total 3 marks)

7. Diagram **NOT** accurately drawn
 PQR is a right-angled triangle.
 $PR = 12$ cm.
 $QR = 4.5$ cm.
 Angle $PRQ = 90^\circ$.
 Work out the value of x .
 Give your answer correct to one decimal place.

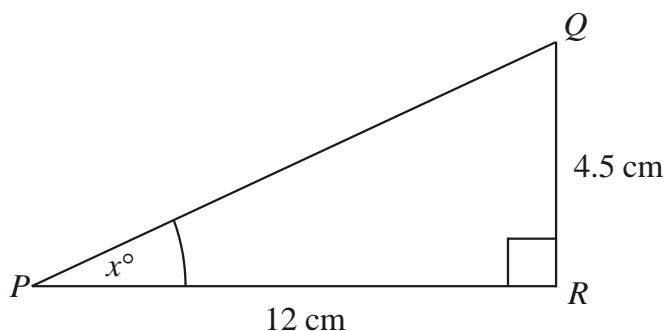

..... °
(Total 3 marks)

Area and Perimeter of Sectors

Things to remember:

- Area of a sector = $\frac{\theta}{360} \times \pi \times r^2$
- Length of an arc = $\frac{\theta}{360} \times \pi \times d$

Questions:

1. Diagram NOT accurately drawn
 OAB is a sector of a circle, centre O .
 Angle $AOB = 60^\circ$.
 $OA = OB = 12$ cm.
 Work out the length of the arc AB .
 Give your answer in terms of π .

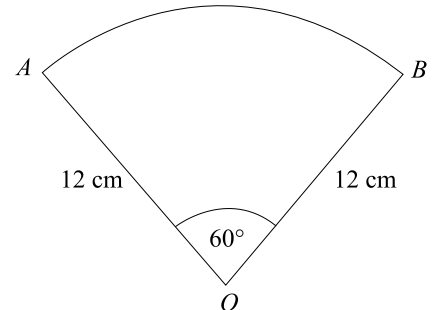

..... cm
(Total 3 marks)

2. Diagram NOT accurately drawn
 The diagram shows a sector of a circle, centre O .
 The radius of the circle is 13 cm.
 The angle of the sector is 150° .
 Calculate the area of the sector.
 Give your answer correct to 3 significant figures.

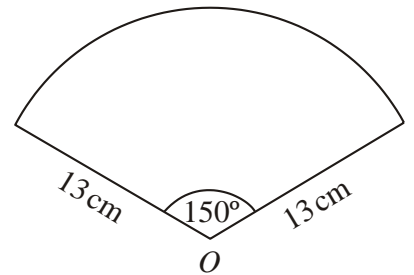

..... cm²
(Total 2 marks)

3. The diagram shows a sector of a circle, centre O .
 The radius of the circle is 9 cm.
 The angle at the centre of the circle is 40° .
 Find the perimeter of the sector.
 Leave your answer in terms of π .

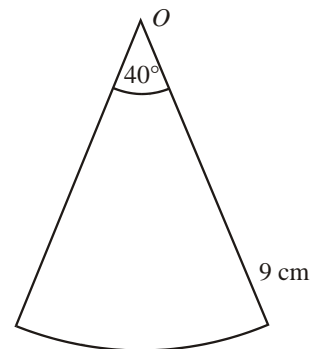
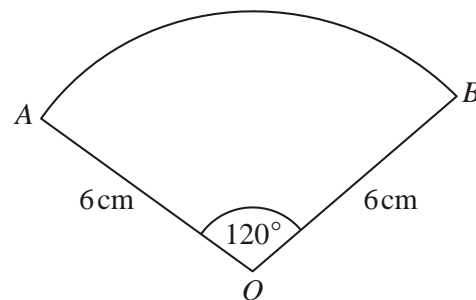

Diagram NOT
 accurately drawn

..... cm
(Total 4 marks)

4. Diagram NOT accurately drawn
 The diagram shows a sector of a circle, centre O .
 The radius of the circle is 6 cm.
 Angle $AOB = 120^\circ$.
 Work out the perimeter of the sector.
 Give your answer in terms of π in its simplest form.



..... cm
(Total 3 marks)

5. Diagram NOT accurately drawn
 The diagram shows a sector of a circle, centre O , radius 10 cm.
 The arc length of the sector is 15 cm.
 Calculate the area of the sector.

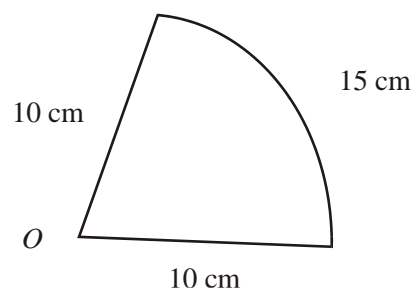

..... cm²
(Total 4 marks)

Volume and Surface Area of Cones and Spheres

Things to remember:

Volume of sphere = $\frac{4}{3}\pi r^3$

Surface area of sphere = $4\pi r^2$

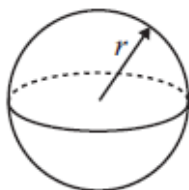

Volume of cone = $\frac{1}{3}\pi r^2 h$

Curved surface area of cone = $\pi r l$

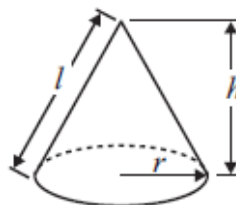

1. The diagram shows a storage tank.
 Diagram **NOT** accurately drawn
 The storage tank consists of a hemisphere on top of a cylinder.
 The height of the cylinder is 30 metres.
 The radius of the cylinder is 3 metres.
 The radius of the hemisphere is 3 metres.

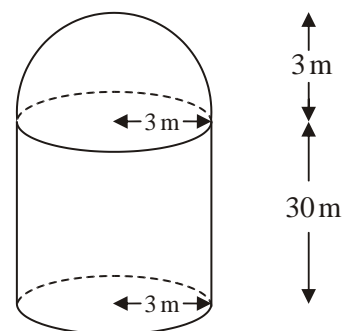

- (a) Calculate the total volume of the storage tank.
 Give your answer correct to 3 significant figures.

..... m³
(3)

A sphere has a volume of 500 m³.

- (b) Calculate the radius of the sphere.
 Give your answer correct to 3 significant figures.

..... m
(3)

(Total 6 marks)

2. A clay bowl is in the shape of a hollow hemisphere.
 Diagram **NOT** accurately drawn
 The external radius of the bowl is 8.2 cm.
 The internal radius of the bowl is 7.7 cm.
 Both measurements are correct to the nearest 0.1 cm.
 The upper bound for the volume of clay is $k\pi$ cm³.
 Find the exact value of k .

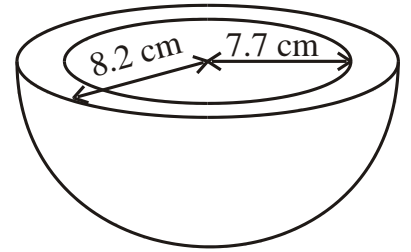

$k = \dots\dots\dots$

(Total 4 marks)

3. Diagram **NOT** accurately drawn
 The diagram represents a cone.
 The height of the cone is 12 cm.
 The diameter of the base of the cone is 10 cm.
 Calculate the curved surface area of the cone.
 Give your answer as a multiple of π .

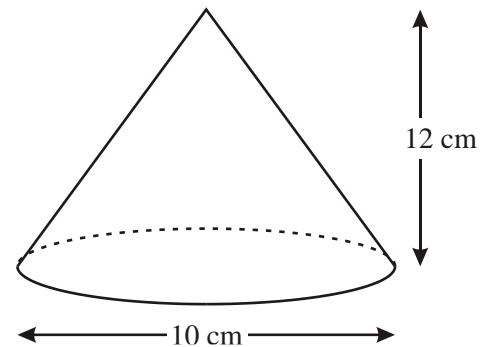

$\dots\dots\dots$ cm²

(Total 3 marks)

4. Diagram **NOT** accurately drawn
 The radius of the base of a cone is 5.7 cm.
 Its slant height is 12.6 cm.
 Calculate the volume of the cone.
 Give your answer correct to 3 significant figures.

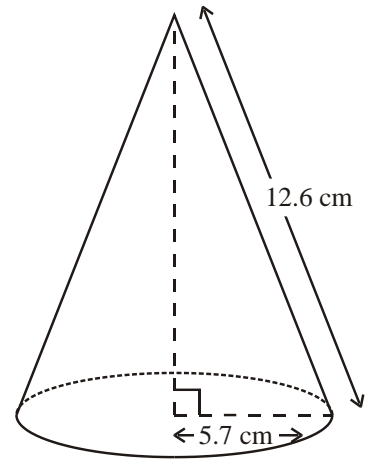

..... cm³
(Total 4 marks)

6. A rectangular container is 12 cm long, 11 cm wide and 10 cm high.
 The container is filled with water to a depth of 8 cm.
 A metal sphere of radius 3.5 cm is placed in the water.
 It sinks to the bottom.
 Calculate the rise in the water level.
 Give your answer correct to 3 significant figures.

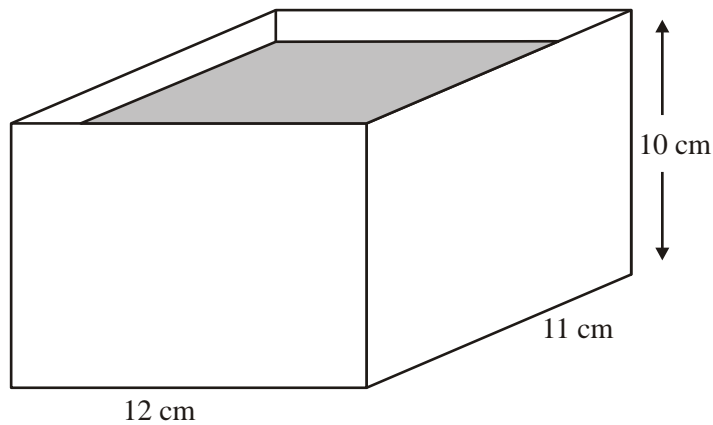
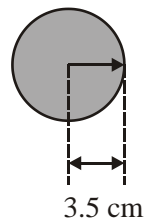

Diagram **NOT** accurately drawn



..... cm
(Total 4 marks)

Similar Length, Area and Volume (LAV)

Things to remember:

- Linear scale factor = x
- Area scale factor = x^2
- Volume scale factor = x^3

Questions:

1. Cylinder **A** and cylinder **B** are mathematically similar.
 The length of cylinder **A** is 4 cm and the length of cylinder **B** is 6 cm.
 The volume of cylinder **A** is 80 cm^3 .

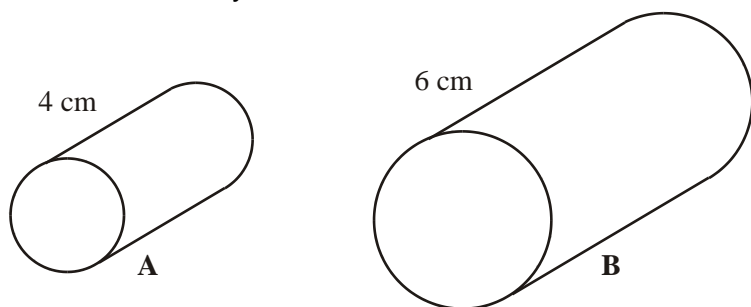

Diagram **NOT**
accurately drawn

Calculate the volume of cylinder **B**.

..... cm^3
(Total 3 marks)

2. Two cylinders, **P** and **Q**, are mathematically similar.
 The total surface area of cylinder **P** is $90\pi \text{ cm}^2$. The total surface area of cylinder **Q** is $810\pi \text{ cm}^2$.
 The length of cylinder **P** is 4 cm.



Diagram **NOT**
accurately drawn

- (a) Work out the length of cylinder **Q**.

..... cm
(3)

The volume of cylinder **P** is $100\pi \text{ cm}^3$.

- (b) Work out the volume of cylinder **Q**.
 Give your answer as a multiple of π

..... cm^3
(2)
(Total 5 marks)

3. Diagram **NOT** accurately drawn
 Two prisms, **A** and **B**, are mathematically similar. The volume of prism **A** is $12\,000\text{ cm}^3$.
 The volume of prism **B** is $49\,152\text{ cm}^3$. The total surface area of prism **B** is 9728 cm^2 .

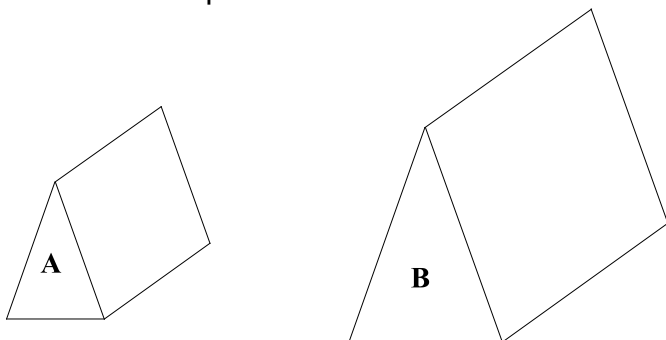

Calculate the total surface area of prism

..... cm^2
(Total 4 marks)

4. Diagram **NOT** accurately drawn
 Two cones, **P** and **Q**, are mathematically similar. The total surface area of cone **P** is 24 cm^2 .
 The total surface area of cone **Q** is 96 cm^2 . The height of cone **P** is 4 cm .

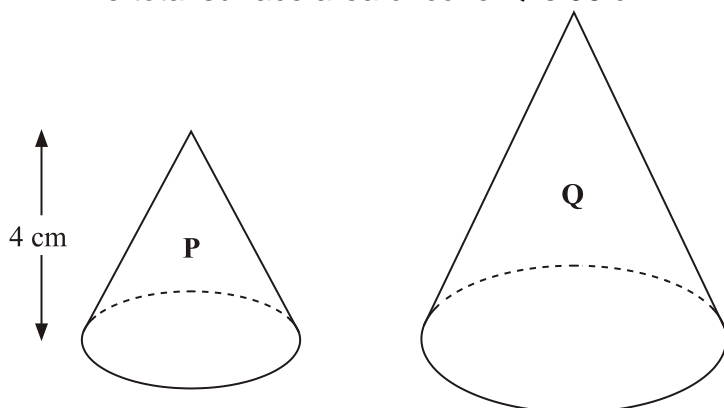

(a) Work out the height of cone **Q**.

..... cm
(3)

The volume of cone **P** is 12 cm^3 .

(b) Work out the volume of cone **Q**.

..... cm^3
(2)
(Total 5 marks)

5. Diagram **NOT** accurately drawn
 Two solid shapes, **A** and **B**, are mathematically similar. The base of shape **A** is a circle with radius 4 cm. The base of shape **B** is a circle with radius 8 cm. The surface area of shape **A** is 80 cm².

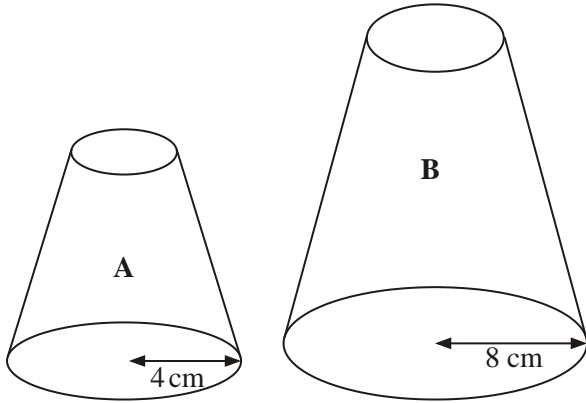

- (a) Work out the surface area of shape **B**.

..... cm²
 (2)

- The volume of shape **B** is 600 cm³.
 (b) Work out the volume of shape **A**.

..... cm³
 (2)
 (Total 4 marks)

6. Diagram **NOT** accurately drawn
 The two cylinders, **A** and **B**, are mathematically similar. The height of cylinder **B** is twice the height of cylinder **A**. The total surface area of cylinder **A** is 180 cm².

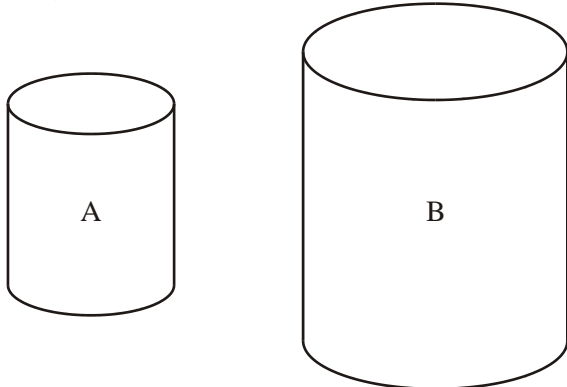

Calculate the total surface area of cylinder **B**.

.....
 (Total 3 marks)

Averages from Tables

Things to remember:

- The mode is the one with the highest frequency.
- To calculate the median, find where the middle value is located by using $\frac{n+1}{2}$.
- The mean is given by $\frac{\sum fx}{\sum f}$, ie. the total frequency x midpoint divided by the total frequency.
- Always look back at the data to check your answer looks realistic.

Questions:

1. Zach has 10 CDs. The table gives some information about the number of tracks on each CD.

Number of tracks	Frequency	
11	1	
12	3	
13	0	
14	2	
15	4	

- (a) Write down the mode.

.....
(1)

- (b) Work out the mean.

.....
(3)
(Total 4 marks)

2. 30 adults took part in a survey. They were each asked how much money they spent on lottery tickets last week. The table shows the results of the survey.

Money (£)	Frequency	
0	5	
2	16	
4	6	
20	2	
30	1	

Work out the mean amount of money the 30 adults spent on lottery tickets.

£
(Total 3 marks)

3. Josh asked 30 adults how many cups of coffee they each drank yesterday. The table shows his results.

Number of cups	Frequency	
0	5	
1	9	
2	7	
3	4	
4	3	
5	2	

Work out the mean.

.....
(Total 3 marks)

4. Majid carried out a survey of the number of school dinners 32 students had in one week. The table shows this information.

Number of school dinners	Frequency	
0	0	
1	8	
2	12	
3	6	
4	4	
5	2	

Calculate the mean.

.....
(Total 3 marks)

5. Fred did a survey on the areas of pictures in a newspaper. The table gives information about the areas.

Area (A cm ²)	Frequency
$0 < A \leq 10$	38
$10 < A \leq 25$	36
$25 < A \leq 40$	30
$40 < A \leq 60$	46

Work out an estimate for the mean area of a picture.

..... cm²
(Total 4 marks)

6. The table gives some information about the time taken by a group of 100 students to complete an IQ test.

Time (t seconds)	Frequency	
$60 < t < 70$	12	
$70 < t < 80$	22	
$80 < t < 90$	23	
$90 < t < 100$	24	
$100 < t < 110$	19	

- (a) Write down the modal class interval.

.....
(1)

- (b) Calculate an estimate for the mean time taken by the students.

..... seconds
(4)
(Total 5 marks)

7. The table gives some information about the time taken by a group of 100 students to complete an IQ test.

Time (t seconds)	Frequenc y	
$60 < t \leq 70$	12	
$70 < t \leq 80$	22	
$80 < t \leq 90$	23	
$90 < t \leq 100$	24	
$100 < t \leq 110$	19	

Calculate an estimate for the mean time taken by the students.

..... seconds
(Total 4 marks)

Sampling

Things to remember:

- Random sampling is where every member of the population has an equal chance of being chosen, which makes it fair.
- With systematic sampling you are unlikely to get a biased sample.
- Stratified sampling is the best way to reflect the population accurately.
- Stratified sample = $\frac{\text{total in group}}{\text{total in population}} \times \text{sample size}$

Questions:

1. In Holborn School there are
460 students in Key Stage 3
320 students in Key Stage 4
165 students in Key Stage 5

Nimer is carrying out a survey.

He needs a sample of 100 students stratified by Key Stage.

Work out the number of students from Key Stage 3 there should be in the sample.

.....
(Total for Question is 2 marks)

2. Henri is carrying out a survey of the people aged 65 and over in his village.
The table shows information about these people.

Age	Male	Female
65 – 69	20	22
70 – 74	18	21
75 – 79	15	18
80 – 84	8	16
85 – 89	5	10
90+	2	5
Total	68	92

Henri is going to take a sample of 30 people stratified by age.

How many people aged 75 – 79 should be in the sample?

.....
(Total for Question is 3 marks)

3. The table shows information about 1065 students.

	Male	Female
Year 7	126	109
Year 8	112	134
Year 9	121	114
Year 10	87	94
Year 11	88	80

Elena takes a stratified sample of 120 students by year group and by gender. Work out the number of Year 8 female students in her sample.

.....
(Total for Question is 2 marks)

4. 156 students went to London. Each student visited one of the British Museum or the National Gallery or the Stock Exchange. The table gives information about these students.

	Place visited		
	British Museum	National Gallery	Stock Exchange
Male	25	18	35
Female	27	32	19

Kate takes a sample of 30 of these students. The sample is stratified by place visited and by gender.

Work out the number of male students who visited the Stock Exchange in the sample.

.....
(Total for Question is 2 marks)

5. There are a total of 300 students in Year 7, Year 8 and Year 9 at Mathsville High School. The table shows information about the students.

	Boys	Girls
Year 7	60	45
Year 8	55	40
Year 9	41	59

The Headteacher takes a sample of 50 students. His sample is stratified by year and by gender. Work out the number of girls from Year 9 in the Headteacher's sample.

.....
(Total for Question is 2 marks)

6. There are 1200 students at a school. Kate is helping to organise a party. She is going to order pizza. Kate takes a sample of 60 of the students at the school. She asks each student to tell her **one** type of pizza they want. The table shows information about her results.

Pizza	Number of students
ham	20
salami	15
vegetarian	8
margherita	17

Work out how much ham pizza Kate should order. Write down any assumption you make **and** explain how this could affect your answer.

.....
.....
(Total for question = 3 marks)

7. (a) Max wants to take a random sample of students from his year group.

(i) Explain what is meant by a random sample.

.....
.....
.....

(ii) Describe a method Max could use to take his random sample.

.....
.....
.....

(2)

(b) The table below shows the numbers of students in 5 year groups at a school.

Year	Number of students
9	239
10	257
11	248
12	190
13	206

Lisa takes a stratified sample of 100 students by year group.
Work out the number of students from Year 9 she has in her sample.

.....
(2)

(Total for Question is 4 marks)

Probability Trees

Things to remember:

- The branches must sum to 1;
- Read the question carefully to decide if it is with replacement or without replacement;
- AND means \times and OR means $+$.

Questions:

1. Amy has 10 CDs in a CD holder.
 Amy's favourite group is Edex.
 She has 6 Edex CDs in the CD holder.
 Amy takes one of these CDs at random.
 She writes down whether or not it is an Edex CD.
 She puts the CD back in the holder.
 Amy again takes one of these CDs at random.
 (a) Complete the probability tree diagram.

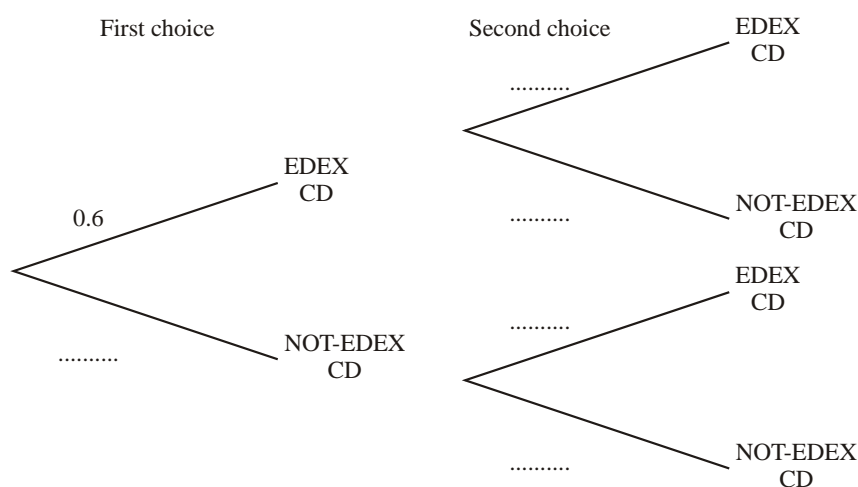

(2)

- Amy had 30 CDs.
 The mean playing time of these 30 CDs was 42 minutes.
 Amy sold 5 of her CDs.
 The mean playing time of the 25 CDs left was 42.8 minutes.
 (b) Calculate the mean playing time of the 5 CDs that Amy sold.

..... minutes

(3)

(Total 5 marks)

2. Amy is going to play one game of snooker and one game of billiards.
 The probability that she will win the game of snooker is $\frac{3}{4}$
 The probability that she will win the game of billiards is $\frac{1}{3}$
 Complete the probability tree diagram.

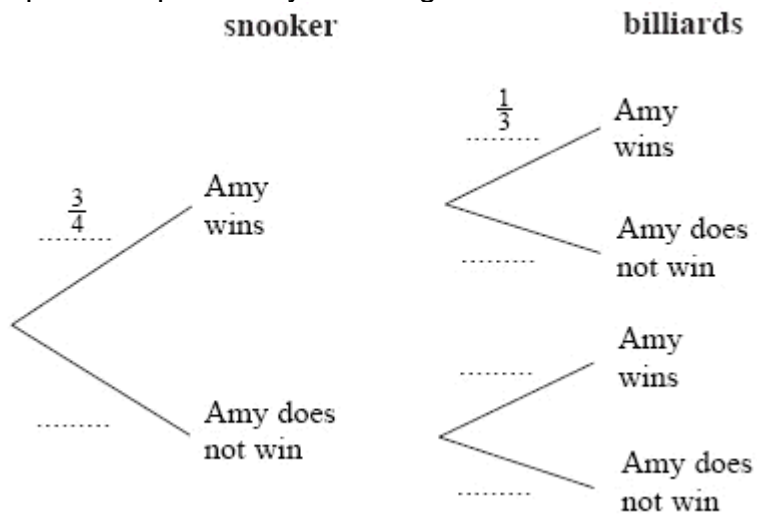

(Total 2 marks)

3. Loren has two bags.
 The first bag contains 3 red counters and 2 blue counters.
 The second bag contains 2 red counters and 5 blue counters.
 Loren takes one counter at random from each bag.
 Complete the probability tree diagram.

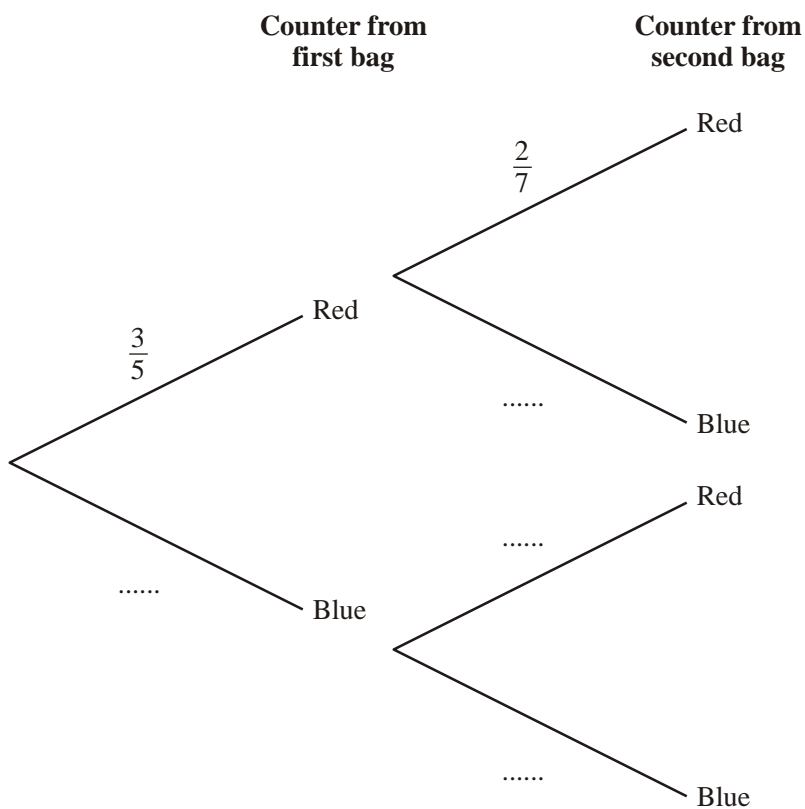

(Total 2 marks)

6. Julie has 100 music CDs. 58 of the CDs are classical. 22 of the CDs are folk. The rest of the CDs are jazz. On Saturday, Julie chooses one CD at random from the 100 CDs. On Sunday, Julie chooses one CD at random from the 100 CDs.
- (a) Complete the probability tree diagram.

(2)

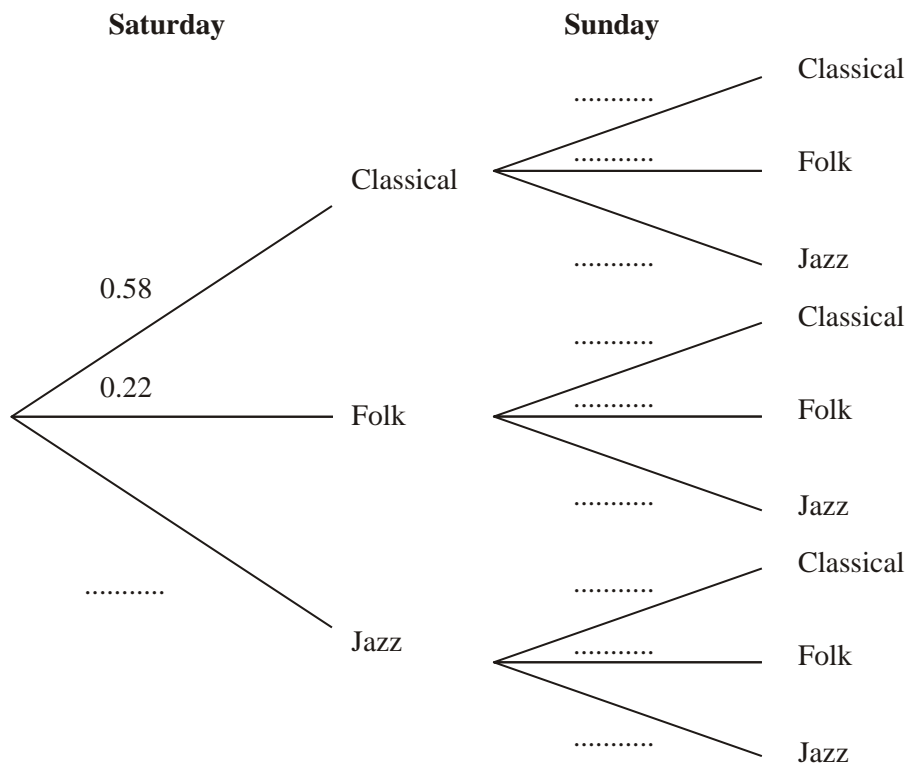

- (b) Calculate the probability that Julie will choose a jazz CD on **both** Saturday and Sunday.

..... (2)

- (c) Calculate the probability that Julie will choose at least one jazz CD on Saturday and Sunday.

..... (3)

(Total 7 marks)

Proportion

Things to remember:

- Start by checking the question for squares, cubes and roots;
- “x is directly proportional to y” looks like $x \propto y$ or $x = ky$
- “x is inversely proportional to y” looks like $x \propto \frac{1}{y}$ or $x = \frac{k}{y}$

Questions:

1. The shutter speed, S , of a camera varies inversely as the square of the aperture setting, f .
When $f = 8$, $S = 125$
- (a) Find a formula for S in terms of f .

-
(b) Hence, or otherwise, calculate the value of S when $f = 4$ (3)

$S =$

(1)
(Total 4 marks)

2. In a factory, chemical reactions are carried out in spherical containers.
The time, T minutes, the chemical reaction takes is directly proportional to the square of the radius, R cm, of the spherical container.
When $R = 120$, $T = 32$
Find the value of T when $R = 150$

$T =$

(Total 4 marks)

3. d is directly proportional to the square of t .
 $d = 80$ when $t = 4$

(a) Express d in terms of t .

.....
(3)

(b) Work out the value of d when $t = 7$

$d =$
(1)

(c) Work out the positive value of t when $d = 45$

$t =$
(2)
(Total 6 marks)

4. The distance, D , travelled by a particle is directly proportional to the square of the time, t , taken. When $t = 40$, $D = 30$

(a) Find a formula for D in terms of t .

$D =$
(3)

(b) Calculate the value of D when $t = 64$

.....
(1)

(c) Calculate the value of t when $D = 12$
Give your answer correct to 3 significant figures.

.....
(2)
(Total 6 marks)

5. The time, T seconds, it takes a water heater to boil some water is directly proportional to the mass of water, m kg, in the water heater. When $m = 250$, $T = 600$

(a) Find T when $m = 400$

$$T = \dots\dots\dots (3)$$

The time, T seconds, it takes a water heater to boil a constant mass of water is inversely proportional to the power, P watts, of the water heater.

When $P = 1400$, $T = 360$

(b) Find the value of T when $P = 900$

$$T = \dots\dots\dots (3)$$

(Total 6 marks)

6. A ball falls vertically after being dropped.
The ball falls a distance d metres in a time of t seconds.
 d is directly proportional to the square of t .
The ball falls 20 metres in a time of 2 seconds.

(a) Find a formula for d in terms of t .

$$d = \dots\dots\dots (3)$$

(b) Calculate the distance the ball falls in 3 seconds.

$$\dots\dots\dots \text{ m} (1)$$

(c) Calculate the time the ball takes to fall 605 m.

$$\dots\dots\dots \text{ seconds} (3)$$

(Total 7 marks)

7. In a spring, the tension (T newtons) is directly proportional to its extension (x cm). When the tension is 150 newtons, the extension is 6 cm.

(a) Find a formula for T in terms of x .

$$T = \dots\dots\dots \text{newtons} \quad (3)$$

(b) Calculate the tension, in newtons, when the extension is 15 cm.

$$\dots\dots\dots \text{newtons} \quad (1)$$

(c) Calculate the extension, in cm, when the tension is 600 newtons.

$$\dots\dots\dots \text{cm} \quad (1)$$

(Total 5 marks)

8. f is inversely proportional to d .
When $d = 50$, $f = 256$
Find the value of f when $d = 80$

$$f = \dots\dots\dots \quad (Total\ 3\ marks)$$

Calculating with Fractions

Things to remember:

- If you have a mixed number, start by converting it to an improper fraction.
- Multiply fractions is easy – just multiply the numerators and multiply the denominators.
- To divide fractions, flip the second fraction upside-down and multiply instead.
- If you need to add or subtract fractions, you will need to start by finding equivalent fractions with a common denominator.
- Make sure you leave your answer in its simplest form.
- To convert a recurring decimal to a fraction you will need to multiply by 10^n , where n is the number of recurring digits. Then subtract the original number from the new one. Rearrange to find the fraction.

Questions:

1. (a) Work out $1\frac{3}{4} + 3\frac{1}{2}$

.....
(2)

(b) Work out $\frac{3}{7} \times \text{£}28$

£.....
(2)

(Total for question = 4 marks)

2. Work out $3\frac{4}{5} + \frac{3}{7}$
Give your answer as a mixed number in its simplest form.

.....
(Total for question = 3 marks)

3. The diagram shows three identical shapes A, B and C.
 $\frac{3}{5}$ of shape A is shaded. $\frac{7}{8}$ of shape C is shaded.

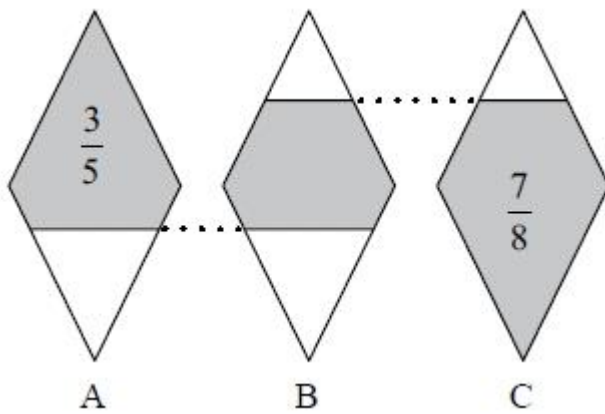

What fraction of shape B is shaded?

(Total for question = 3 marks)

4. Express the recurring decimal $0.1\dot{5}$ as a fraction.
 Give your answer in its simplest form.

.....
(Total for Question is 3 marks)

5. Work out $3\frac{1}{3} \times 4\frac{2}{5}$
Give your answer as a mixed number in its simplest form.

.....
(Total for question = 3 marks)

6. Work out $\frac{3}{8} + \frac{1}{3}$

.....
(Total for Question is 2 marks)

7. Express the recurring decimal $0.7\dot{5}\dot{0}$ as a fraction.

.....
(Total for Question is 3 marks)

8. Express the recurring decimal $0.2\overline{81}$ as a fraction in its simplest form.

.....
(Total for Question is 3 marks)

9. Work out $3\frac{1}{3} \div 4\frac{3}{4}$

.....
(Total for Question is 2 marks)

10. On a farm, $4\frac{1}{2}$ out of every 15 acres of the land are used to grow crops.
Wheat is grown on $\frac{5}{8}$ of the land used to grow crops.
What percentage of the total area of the land on the farm is used to grow wheat?

(Total for question = 3 marks)

Percentages – compound interest

Things to remember:

- New amount = original amount x multiplierⁿ ← Number of years

Questions:

1. Henry invests £4500 at a compound interest rate of 5% per annum. At the end of n complete years the investment has grown to £5469.78. Find the value of n .

.....
(Total 2 marks)

2. Bill buys a new machine. The value of the machine depreciates by 20% each year.
(a) Bill says 'after 5 years the machine will have no value'. Bill is **wrong**. Explain why.

.....
.....
.....
(1)

Bill wants to work out the value of the machine after 2 years.
(b) By what single decimal number should Bill multiply the value of the machine when new?
.....
(2)
(Total 3 marks)

3. Gwen bought a new car. Each year, the value of her car depreciated by 9%. Calculate the number of years after which the value of her car was 47% of its value when new.

.....
(Total 3 marks)

4. The value of a car depreciates by 35% each year. At the end of 2007 the value of the car was £5460. Work out the value of the car at the end of 2006

£
(Total 3 marks)

5. Toby invested £4500 for 2 years in a savings account.
He was paid 4% per annum compound interest.
(a) How much did Toby have in his savings account after 2 years?

£
(3)

- Jaspir invested £2400 for n years in a savings account.
He was paid 7.5% per annum compound interest.
At the end of the n years he had £3445.51 in the savings account.
(b) Work out the value of n .

.....
(2)
(Total 5 marks)

6. Mario invests £2000 for 3 years at 5% per annum **compound** interest.
Calculate the value of the investment at the end of 3 years.

£
(Total 3 marks)

7. Toby invested £4500 for 2 years in a savings account.
He was paid 4% per annum compound interest.
How much did Toby have in his savings account after 2 years?

£
(Total 3 marks)

Percentages – reverse

Things to remember:

- Work out what the multiplier would have been;

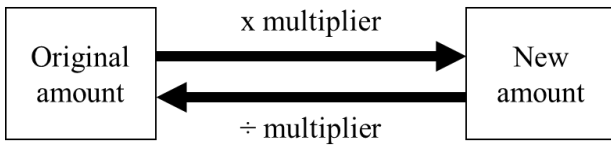

Questions:

1. Loft insulation reduces annual heating costs by 20%.
After he insulated his loft, Curtley’s annual heating cost was £520.
 Work out Curtley’s annual heating cost would have been, if he had not insulated his loft.

£
(Total 3 marks)

2. In a sale, normal prices are reduced by 20%.

SALE
20% OFF

Andrew bought a saddle for his horse in the sale.
 The sale price of the saddle was £220.
 Calculate the normal price of the saddle.

£
(Total 3 marks)

3. Hajra’s weekly pay this year is £240
 This is 20% more than her weekly pay last year.
 Bill says ‘This means Hajra’s weekly pay last year was £192’.
 Bill is wrong,
 (a) Explain why.

.....

(1)

- (b) Work out Hajra’s weekly pay last year.

£
(2)
(Total 3 marks)

4. The price of all rail season tickets to London increased by 4%.
(a) The price of a rail season ticket from Cambridge to London increased by £121.60
Work out the price before this increase.

£
(2)

- (b) After the increase, the price of a rail season ticket from Brighton to London was
£2828.80
Work out the price before this increase.

£
(3)
(Total 5 marks)

5. In a sale, normal prices are reduced by 25%.
The sale price of a saw is £12.75
Calculate the normal price of the saw.

£
(Total 3 marks)

6. In a sale, normal prices are reduced by 12%.
The sale price of a DVD player is £242.
Work out the normal price of the DVD player.

£
(Total 3 marks)

7. A garage sells cars.
It offers a discount of 20% off the normal price for cash.
Dave pays £5200 cash for a car.
Calculate the normal price of the car.

£
(Total 3 marks)

